

Resonant Mode Combi IGBT®

The Thunderbolt HS™ IGBT used in this resonant mode combi is based on thin wafer non-punch through (NPT) technology similar to the Thunderbolt® series, but trades higher $V_{CE(ON)}$ for significantly lower turn-on energy E_{off} . The low switching losses enable operation at switching frequencies over 100kHz, approaching power MOSFET performance but lower cost.

An extremely tight parameter distribution combined with a positive $V_{CE(ON)}$ temperature coefficient make it easy to parallel Thunderbolts HS™ IGBT's. Controlled slew rates result in very good noise and oscillation immunity and low EMI. The short circuit duration rating of 10 μ s make these IGBT's suitable for motor drive and inverter applications. Reliability is further enhanced by avalanche energy ruggedness. Combi versions are packaged with a high speed, soft recovery DL series diode.

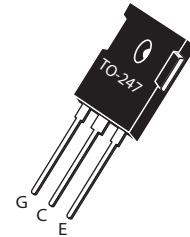

Single die IGBT with separate DL

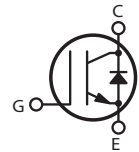

Features

- Fast Switching with low EMI
- Very Low E_{OFF} for Maximum Efficiency
- Short circuit rated
- Low Gate Charge
- RoHS Compliant
- Tight parameter distribution
- Easy paralleling
- Low Forward Diode Voltage (VF)
- Ultrasoft Recovery Diode

Typical Applications

- ZVS Phase Shifted Bridge
- Resonant Mode Switching
- Phase Shifted Bridge
- Welding
- Induction heating
- High Frequency SMPS

Absolute Maximum Ratings

Symbol	Parameter	Rating	Unit
I_{C1}	Continuous Collector Current $T_C = @ 25^\circ C$	54	A
I_{C2}	Continuous Collector Current $T_C = @ 100^\circ C$	30	
I_{CM}	Pulsed Collector Current ¹	113	
V_{GE}	Gate-Emitter Voltage	$\pm 30V$	V
SSOA	Switching Safe Operating Area	113	
t_{SC}	Short Circuit Withstand Time ³	10	μs

Thermal and Mechanical Characteristics

Symbol	Parameter	Min	Typ	Max	Unit
P_D	Total Power Dissipation $T_C = @ 25^\circ C$	-	-	250	W
$R_{\theta JC}$	Junction to Case Thermal Resistance	IGBT	-	0.50	$^\circ C/W$
		Diode		1.0	
$R_{\theta CS}$	Case to Sink Thermal Resistance, Flat Greased Surface	-	0.11	-	
T_J, T_{STG}	Operating and Storage Junction Temperature Range	-55	-	150	$^\circ C$
T_L	Soldering Temperature for 10 Seconds (1.6mm from case)	-	-	300	
W_T	Package Weight	-	0.22	-	
		-	5.9	-	g

CAUTION: These Devices are Sensitive to Electrostatic Discharge. Proper Handling Procedures Should be Followed.

Static Characteristics

$T_J = 25^\circ\text{C}$ unless otherwise specified

APT30GS60BRDL(G)

Symbol	Parameter	Test Conditions	Min	Typ	Max	Unit	
$V_{BR(CES)}$	Collector-Emitter Breakdown Voltage	$V_{GE} = 0V, I_C = 250\mu A$	600	-	-	V	
$\Delta V_{BR(CES)}/\Delta T_J$	Breakdown Voltage Temperature Coeff	Reference to $25^\circ\text{C}, I_C = 250\mu A$	-	0.60	-	$V/^\circ\text{C}$	
$V_{CE(ON)}$	Collector-Emitter On Voltage ⁴ ○	$V_{GE} = 15V$ $I_C = 30A$	$T_J = 25^\circ\text{C}$	-	2.8	3.15	V
			$T_J = 125^\circ\text{C}$	-	3.25	-	
$V_{GE(th)}$	Gate-Emitter Threshold Voltage	$V_{GE} = V_{CE}, I_C = 1mA$	3	4	5	$mV/^\circ\text{C}$	
$\Delta V_{GE(th)}/\Delta T_J$	Threshold Voltage Temp Coeff		-	6.7	-		
I_{CES}	Zero Gate Voltage Collector Current	$V_{CE} = 600V,$ $V_{GE} = 0V$	$T_J = 25^\circ\text{C}$	-	-	50	μA
			$T_J = 125^\circ\text{C}$	-	-	1000	
I_{GES}	Gate-Emitter Leakage Current	$V_{GE} = \pm 20V$	-	-	± 100	nA	

Dynamic Characteristics

$T_J = 25^\circ\text{C}$ unless otherwise specified

Symbol	Parameter	Test Conditions	Min	Typ	Max	Unit
g_{fs}	Forward Transconductance	$V_{CE} = 50V, I_C = 30A$	-	18	-	S
C_{ies}	Input Capacitance	$V_{GE} = 0V, V_{CE} = 25V$ $f = 1MHz$	-	1600	-	pF
C_{oes}	Output Capacitance		-	140	-	
C_{res}	Reverse Transfer Capacitance		-	90	-	
$C_{o(cr)}$	Reverse Transfer Capacitance Charge Related ⁵	$V_{GE} = 0V$ $V_{CE} = 0$ to $400V$	-	130	-	pF
$C_{o(er)}$	Reverse Transfer Capacitance Current Related ⁶		-	95	-	
Q_g	Total Gate Charge	$V_{GE} = 0$ to $15V$ $I_C = 30A, V_{CE} = 300V$	-	145	-	nC
Q_{ge}	Gate-Emitter Charge		-	12	-	
G_{gc}	Gate-Collector Charge		-	65	-	
$t_{d(on)}$	Turn-On Delay Time	Inductive Switching IGBT and Diode: $T_J = 25^\circ\text{C}, V_{CC} = 400V,$ $I_C = 30A$ $R_G = 9.1\Omega^7, V_{GG} = 15V$	-	16	-	ns
t_r	Rise Time		-	29	-	
$t_{d(off)}$	Turn-Off Delay Time		-	360	-	
t_f	Fall Time		-	27	-	
E_{on1}	Turn-On Switching Energy ⁸		-	TBD	-	
E_{on2}	Turn-On Switching Energy ⁹	Inductive Switching IGBT and Diode: $T_J = 125^\circ\text{C}, V_{CC} = 400V,$ $I_C = 30A$ $R_G = 9.1\Omega^7, V_{GG} = 15V$	-	800	-	μJ
E_{off}	Turn-Off Switching Energy ¹⁰		-	570	-	
$t_{d(on)}$	Turn-On Delay Time		-	16	-	
t_r	Rise Time	-	29	-	ns	
$t_{d(off)}$	Turn-Off Delay Time	-	390	-		
t_f	Fall Time	-	22	-		
E_{on1}	Turn-On Switching Energy ⁸	Inductive Switching IGBT and Diode: $T_J = 125^\circ\text{C}, V_{CC} = 400V,$ $I_C = 30A$ $R_G = 9.1\Omega^7, V_{GG} = 15V$	-	TBD	-	μJ
E_{on2}	Turn-On Switching Energy ⁹		-	1185	-	
E_{off}	Turn-Off Switching Energy ¹⁰		-	695	-	

TYPICAL PERFORMANCE CURVES

APT30GS60BRDL(G)

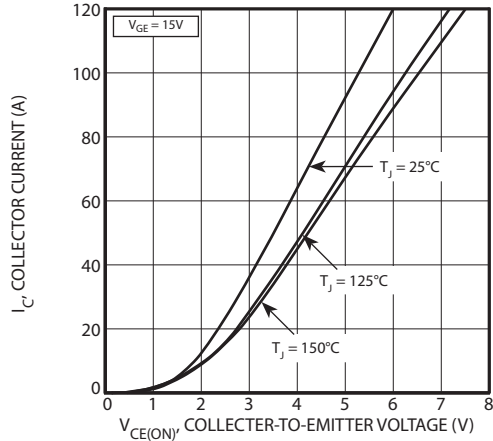

FIGURE 1, Output Characteristics

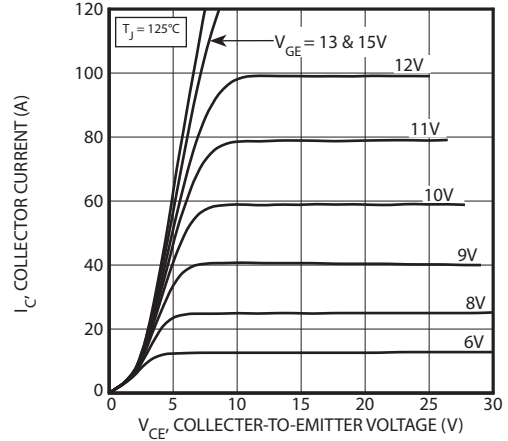

FIGURE 2, Output Characteristics

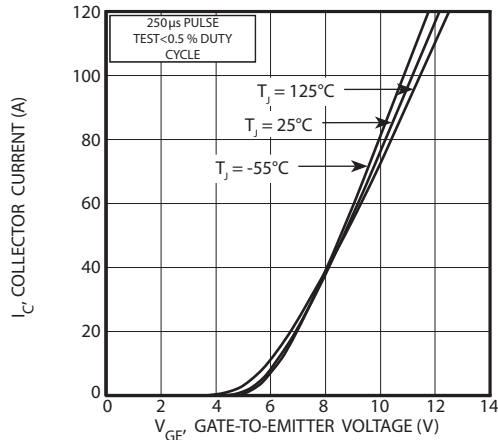

FIGURE 3, Transfer Characteristics

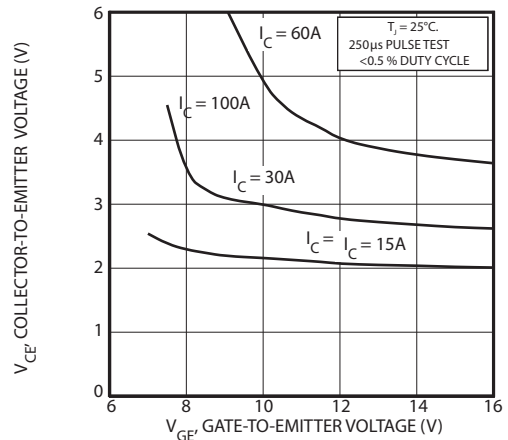

FIGURE 4, On State Voltage vs Gate-to-Emitter Voltage

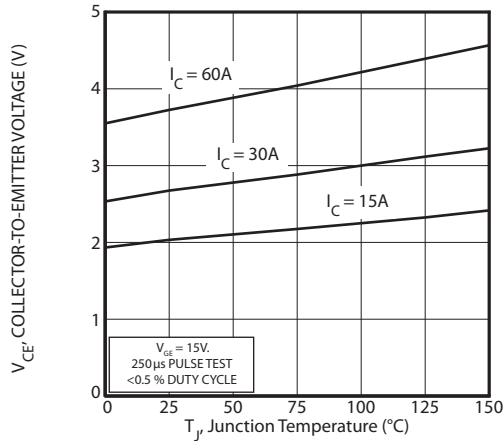

FIGURE 5, On State Voltage vs Junction Temperature

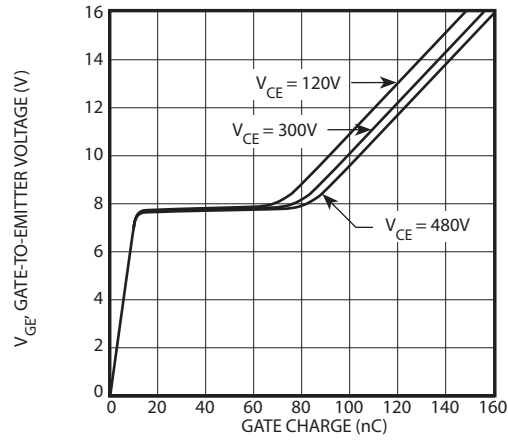

FIGURE 6, Gate Charge

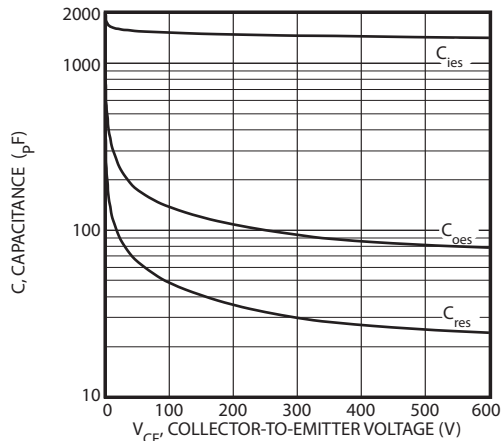

FIGURE 7, Capacitance vs Collector-To-Emitter Voltage

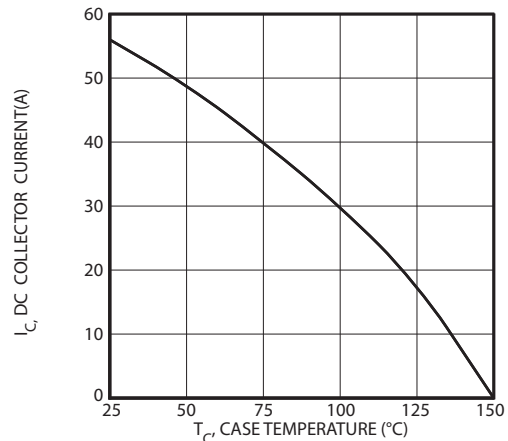

FIGURE 8, DC Collector Current vs Case Temperature

TYPICAL PERFORMANCE CURVES

APT30GS60BRDL(G)

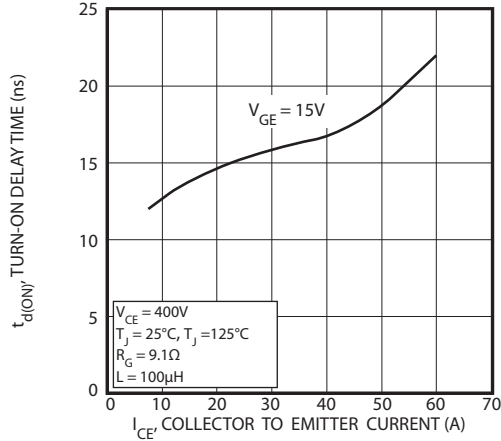

FIGURE 9, Turn-On Delay Time vs Collector Current

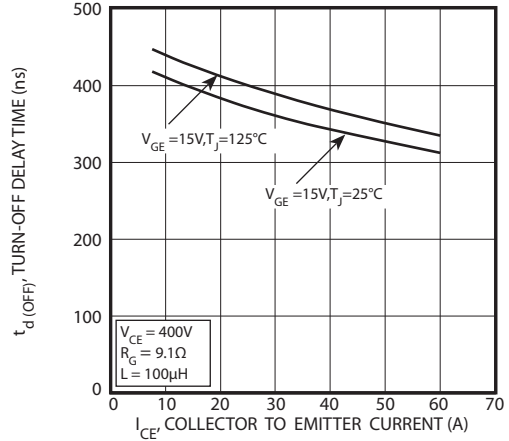

FIGURE 10, Turn-Off Delay Time vs Collector Current

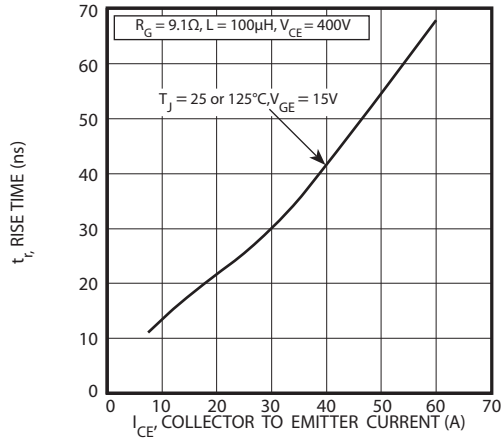

FIGURE 11, Current Rise Time vs Collector Current

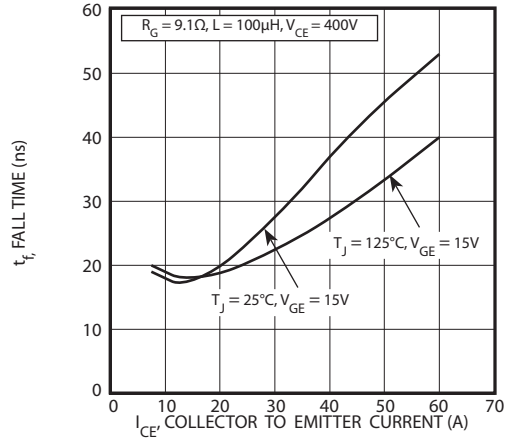

FIGURE 12, Current Fall Time vs Collector Current

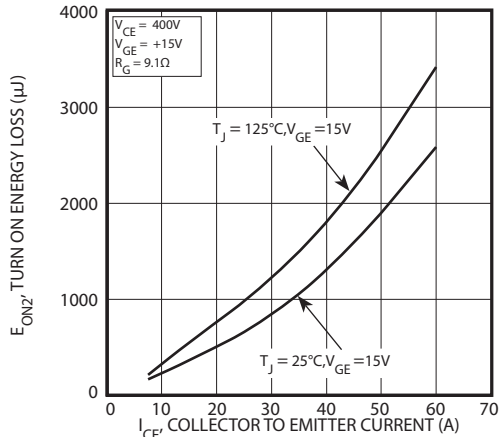

FIGURE 13, Turn-On Energy Loss vs Collector Current

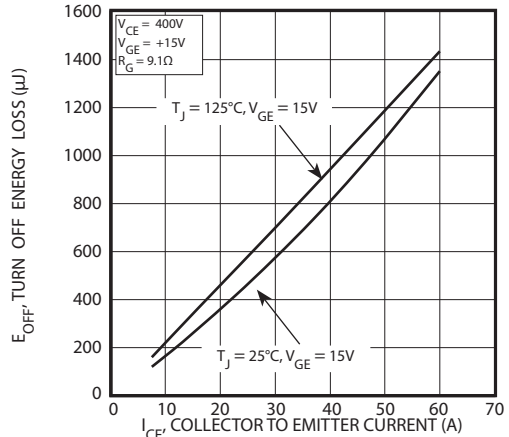

FIGURE 14, Turn Off Energy Loss vs Collector Current

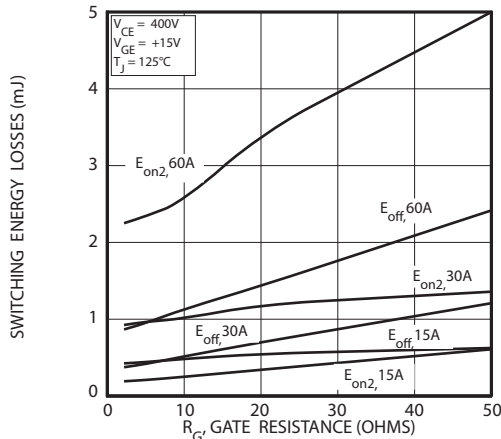

FIGURE 15, Switching Energy Losses vs. Gate Resistance

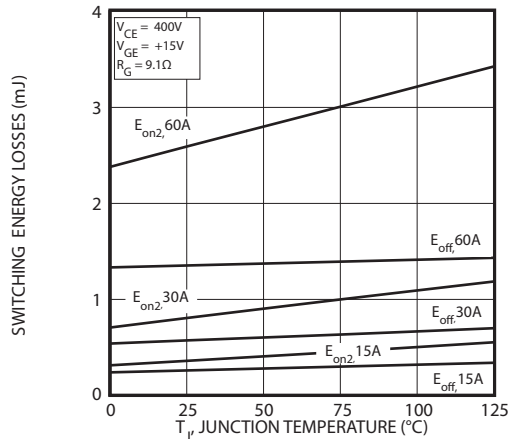
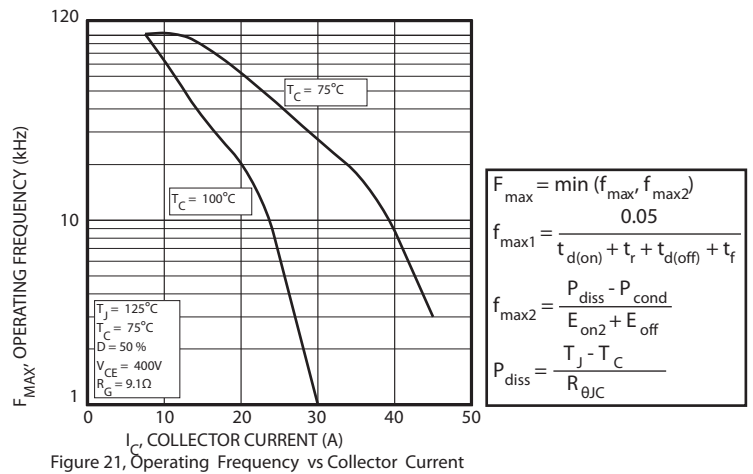
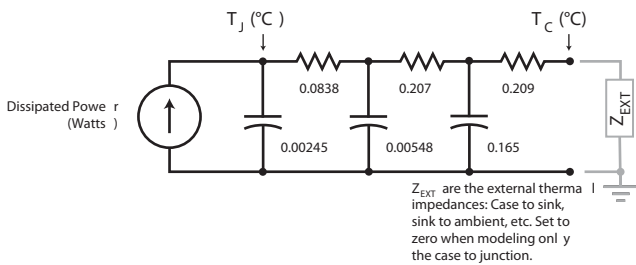
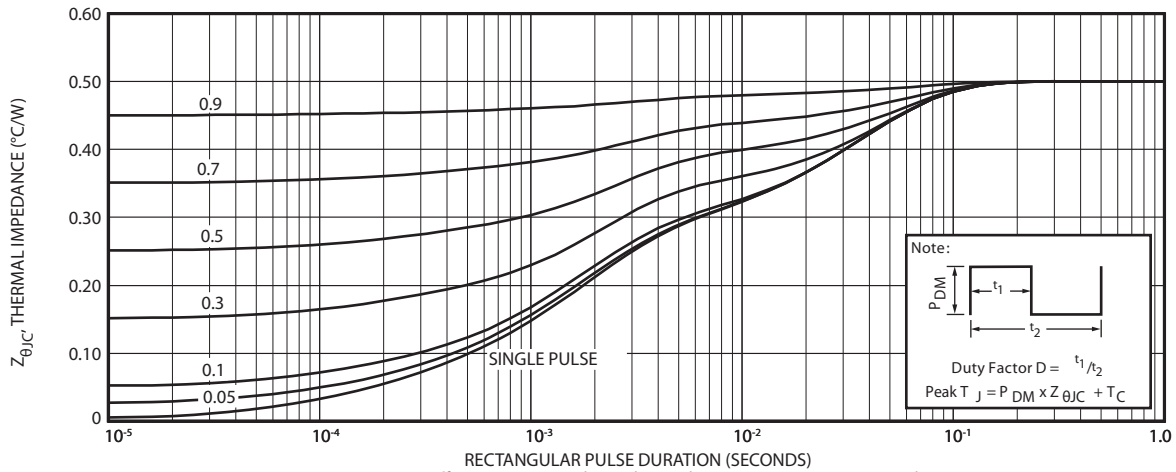
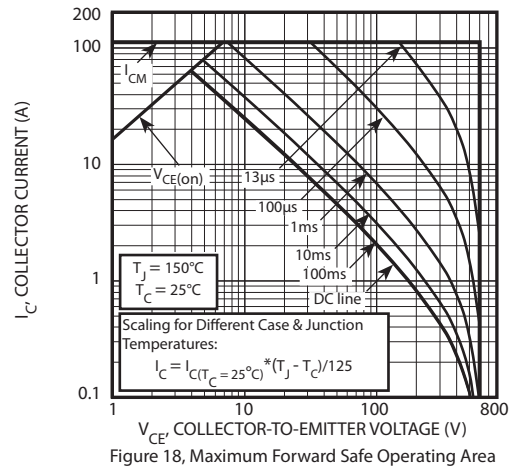
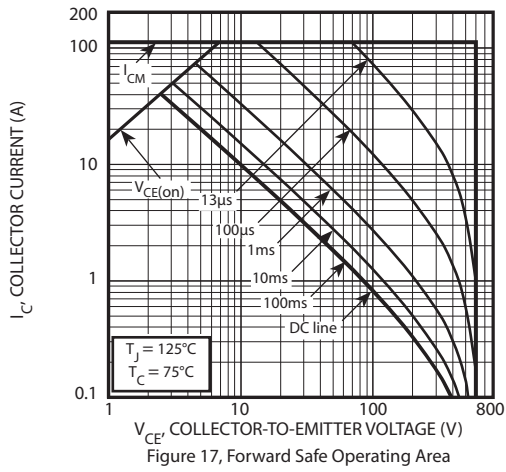

FIGURE 16, Switching Energy Losses vs Junction Temperature



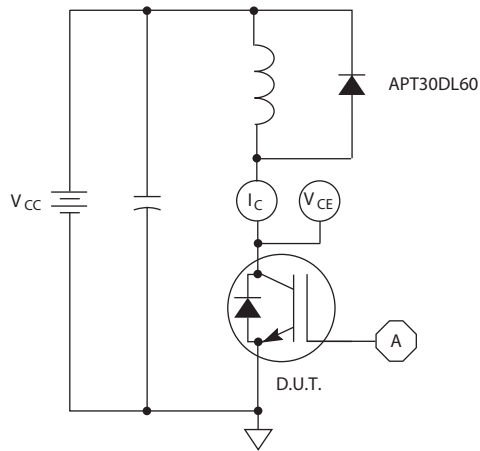

Figure 22, Inductive Switching Test Circuit

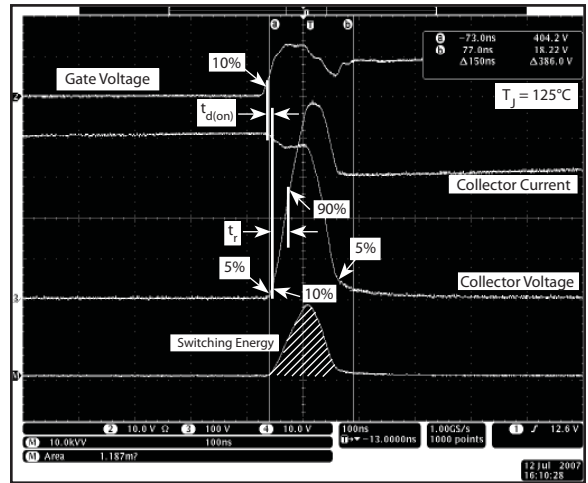

Figure 23, Turn-on Switching Waveforms and Definitions

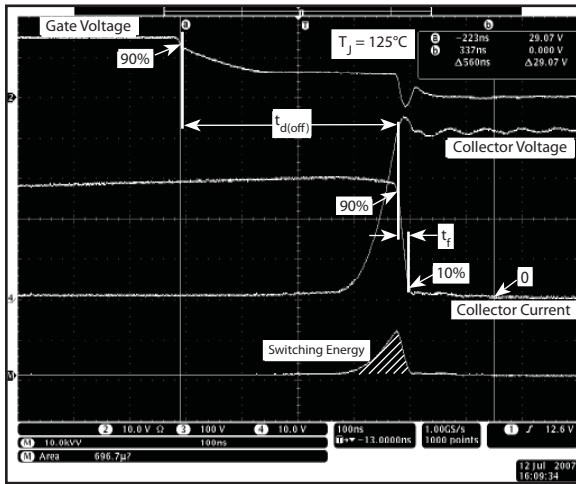

Figure 24, Turn-off Switching Waveforms and Definitions

FOOT NOTE:

- ① Repetitive Rating: Pulse width and case temperature limited by maximum junction temperature.
- ③ Short circuit time: $V_{GE} = 15V, V_{CC} \leq 600V, T_j \leq 150^\circ C$
- ④ Pulse test: Pulse width < 380 μs , duty cycle < 2%
- ⑤ $C_{o(cr)}$ is defined as a fixed capacitance with the same stored charge as C_{oes} with $V_{CE} = 67\%$ of $V_{(BR)CES}$.
- ⑥ $C_{o(er)}$ is defined as a fixed capacitance with the same stored energy as C_{oes} with $V_{CE} = 67\%$ of $V_{(BR)CES}$. To calculate $C_{o(er)}$ for any value of V_{CE} less than $V_{(BR)CES}$, use this equation: $C_{o(er)} = -1.40E-7/V_{DS}^2 + 1.47E-8/V_{DS} + 5.95E-11$.
- ⑦ R_g is external gate resistance, not including internal gate resistance or gate driver impedance (MIC4452).
- ⑧ E_{on1} is the inductive turn-on energy of the IGBT only, without the effect of a commutating diode reverse recovery current adding to the IGBT turn-on switching loss. It is measured by clamping the inductance with a Silicon Carbide Schottky diode.
- ⑨ E_{on2} is the inductive turn-on energy that includes a commutating diode reverse recovery current in the IGBT turn-on energy.
- ⑩ E_{off} is the clamped inductive turn-off energy measured in accordance with JEDEC standard JESD24-1.

Microsemi reserves the right to change, without notice, the specifications and information contained herein.

ULTRAFAST SOFT RECOVERY ANTI-PARALLEL DIODE

MAXIMUM RATINGS

All Ratings: $T_C = 25^\circ\text{C}$ unless otherwise specified.

Symbol	Characteristic / Test Conditions	APT30GS60BRDL(G)		UNIT
$I_F(AV)$	Maximum Average Forward Current ($T_C = 126^\circ\text{C}$, Duty Cycle = 0.5)	30		Amps
$I_F(RMS)$	RMS Forward Current (Square wave, 50% duty)	51		
I_{FSM}	Non-Repetitive Forward Surge Current ($T_J = 45^\circ\text{C}$, 8.3ms)	320		

STATIC ELECTRICAL CHARACTERISTICS

Symbol	Characteristic / Test Conditions	MIN	TYP	MAX	UNIT
V_F	Forward Voltage	$I_F = 30\text{A}$	1.25	1.6	Volts
		$I_F = 60\text{A}$	2.0		
		$I_F = 30\text{A}, T_J = 125^\circ\text{C}$	1.25		

DYNAMIC CHARACTERISTICS

Symbol	Characteristic	Test Conditions	MIN	TYP	MAX	UNIT
t_{rr}	Reverse Recovery Time	$I_F = 1\text{A}, di_F/dt = -100\text{A}/\mu\text{s}, V_R = 30\text{V}, T_J = 25^\circ\text{C}$	-	64		ns
t_{rr}	Reverse Recovery Time	$I_F = 30\text{A}, di_F/dt = -200\text{A}/\mu\text{s}, V_R = 400\text{V}, T_C = 25^\circ\text{C}$	-	317		
Q_{rr}	Reverse Recovery Charge		-	962		nC
I_{RRM}	Maximum Reverse Recovery Current		-	7	-	Amps
t_{rr}	Reverse Recovery Time	$I_F = 30\text{A}, di_F/dt = -200\text{A}/\mu\text{s}, V_R = 400\text{V}, T_C = 125^\circ\text{C}$	-	561		ns
Q_{rr}	Reverse Recovery Charge		-	2244		nC
I_{RRM}	Maximum Reverse Recovery Current		-	9	-	Amps
t_{rr}	Reverse Recovery Time	$I_F = 30\text{A}, di_F/dt = -1000\text{A}/\mu\text{s}, V_R = 400\text{V}, T_C = 125^\circ\text{C}$	-	264		ns
Q_{rr}	Reverse Recovery Charge		-	3191		nC
I_{RRM}	Maximum Reverse Recovery Current		-	26		Amps

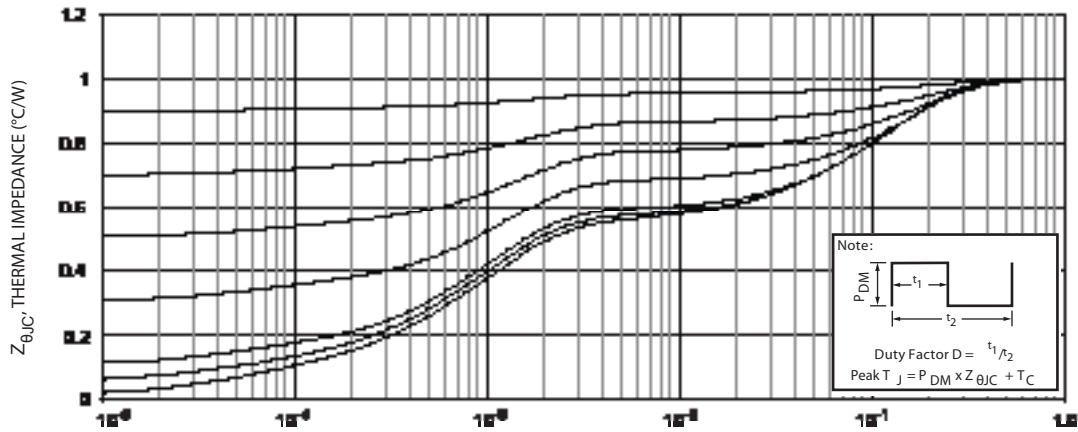

FIGURE 1a. MAXIMUM EFFECTIVE TRANSIENT THERMAL IMPEDANCE, JUNCTION-TO-CASE vs. PULSE DURATION

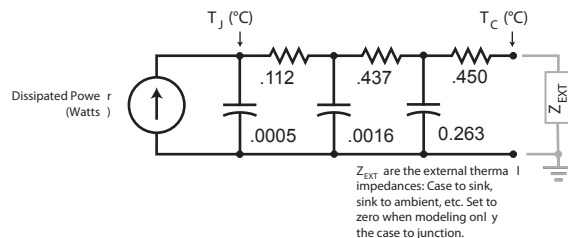

FIGURE 1b, TRANSIENT THERMAL IMPEDANCE MODEL

TYPICAL PERFORMANCE CURVES

APT30GS60BRDL(G)

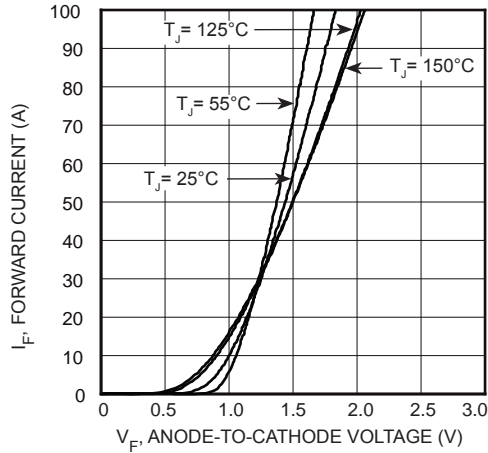

FIGURE 2, Forward Current vs. Forward Voltage

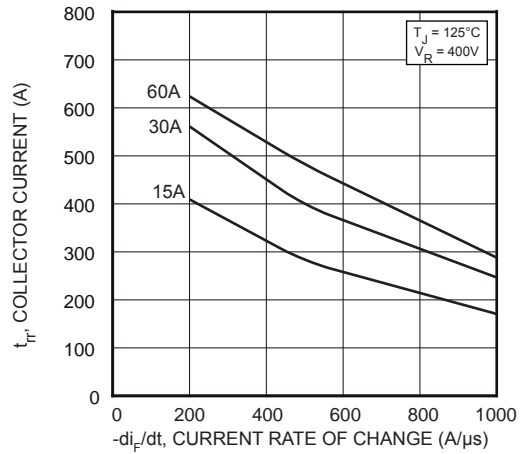

FIGURE 3, Reverse Recovery Time vs. Current Rate of Change

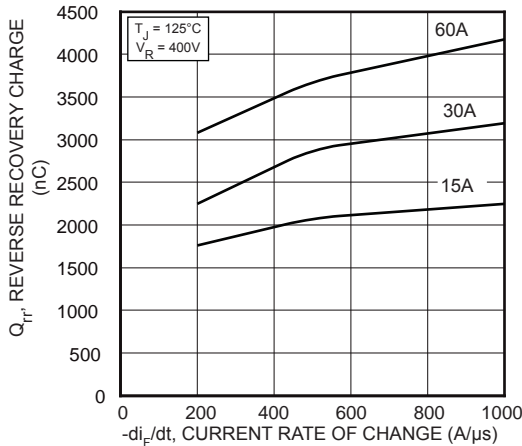

FIGURE 4, Reverse Recovery Charge vs. Current Rate of Change

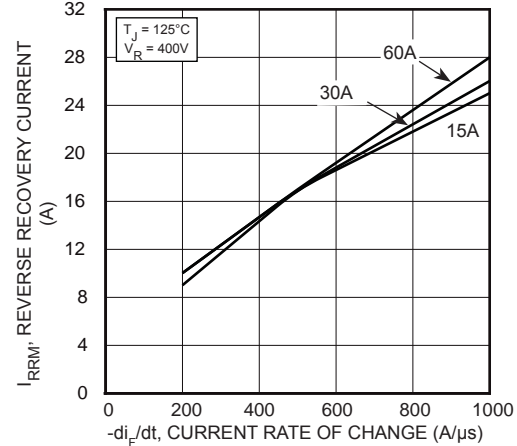

FIGURE 5, Reverse Recovery Current vs. Current Rate of Change

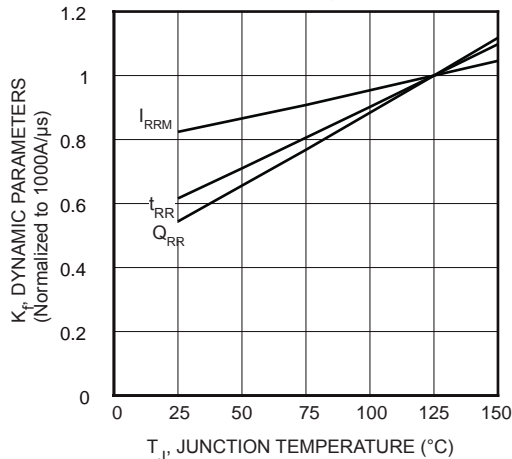

FIGURE 6, Dynamic Parameters vs. Junction Temperature

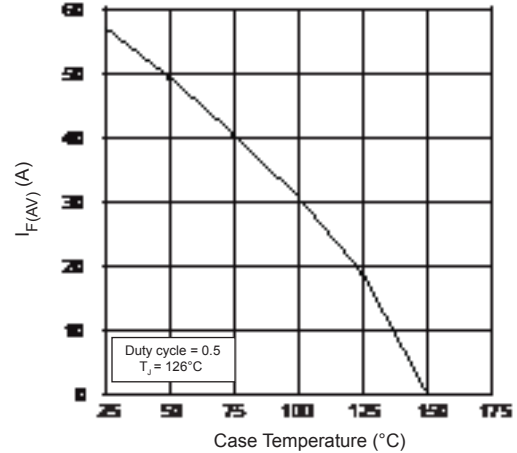

FIGURE 7, Maximum Average Forward Current vs. Case Temperature

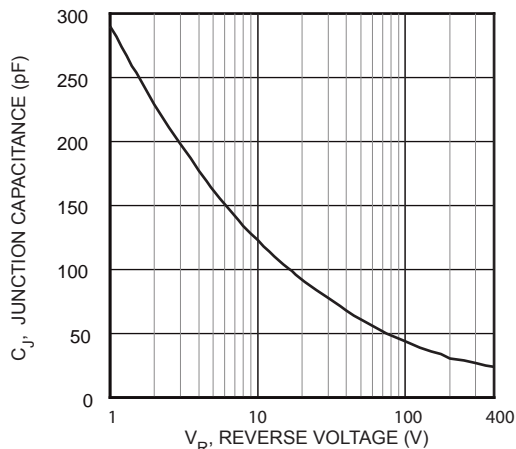

FIGURE 8, Junction Capacitance vs. Reverse Voltage

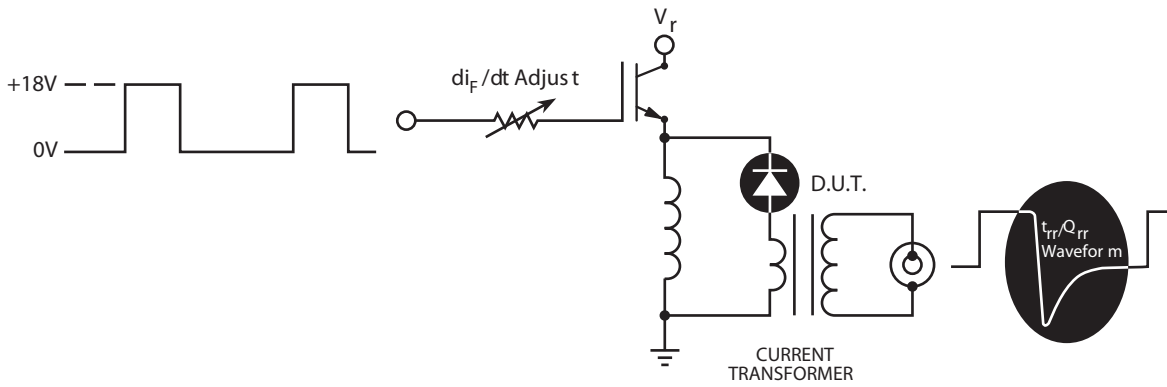

Figure 9. Diode Test Circuit

- 1 I_F - Forward Conduction Current
- 2 di_F/dt - Rate of Diode Current Change Through Zero Crossing.
- 3 I_{RRM} - Maximum Reverse Recovery Current
- 4 t_{rr} - Reverse Recovery Time, measured from zero crossing where the diode current goes from positive to negative, to the point at which the straight line through I_{RRM} and $0.25 I_{RRM}$ passes through zero.
- 5 Q_{rr} - Area Under the Curve Defined by I_{RRM} and t_{rr} .
- 6 di_M/dt - Maximum Rate of Current Increase During the Trailing Portion of t_{rr} .

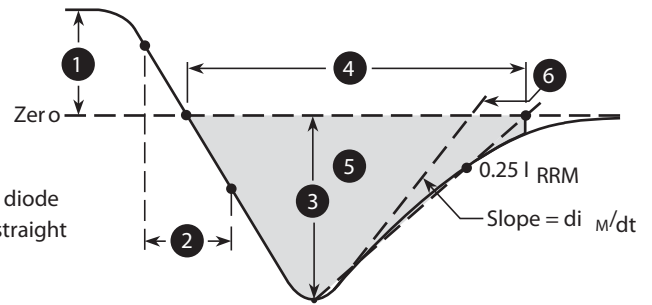
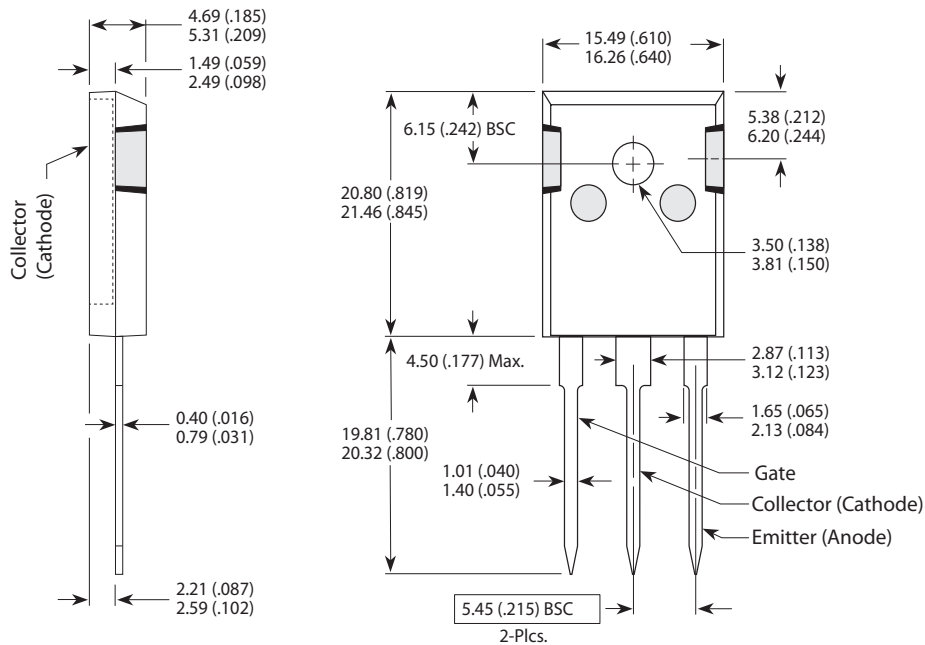

Figure 10, Diode Reverse Recovery Waveform and Definition

TO-247 (B) Package Outline



Dimensions in Millimeters and (Inches)