

GlobTek, Inc. www.globtek.com 186 Veterans Drive, Northvale, NJ 07647 Tel. (201) 784-1000 Fax (201) 784-0111	Drawing Title: GT-46120-1212, ITE Power Supply, Efficiency Level: VI, Case Color/Style: GlobTek Black, Wall Plug-in, Regulated Switchmode AC-DC Power Supply AC Adaptor, Input Rating: 100-240V~, 50-60 Hz, Interchangeable Blades http://en.globtek.com/interchangeable-blades.php , Output Rating: 12W, 12V@1A, Output Configuration: 1230 mm, 18/1C + Shield Cond, UL 1185, Female Barrel 5.5*2.1*11mm w/ Spring Clip & Locking Notch or Equal, Ferrite: None, GlobTek Black, GT Cord # C2916, Pin Out: Center Positive (+V), Blades/Input Cord: Q-Series N. American, Approvals: 230V CoC Tier 2 WEEE VCCI Ukraine RoHS EAC Level VI Double Insulation China RoHS CE PSE	
	Model No. GT-46120-1212	
	Part No./Ordering No. WR9QE1000CCPNA-N(R6B)	Rev B

REVISION HISTORY

REV	DESCRIPTION	SUB	DATE	APPROVED
B	Update packaging Update Ukraine No	rchiu	10/23/2017	QA
A	Initial Release	jwarn	05/02/2017	QA

In Addition to GlobTek Inc.'s renewed ISO9001:2008 - Quality Management System Certification, GlobTek Inc. is now certified to:

ISO13485:2003 - Medical Devices Quality Management System Certification

ISO14001:2004 - Environmental Management System Certification

ISO Certificates are available online at <http://www.globtek.com/iso-certificates/>

Customer Approval of Specification:

Please approve, sign and send back to GlobTek so we can complete order processing.

A delay in receipt of this form will delay delivery schedule.

Company Name:

Customer P/N:

Quote Number:

Date:

Authorized Representative Name:

Authorized Representative Signature:

The acceptance of this specification and use of the product described in this document indicates the acceptance and binding of the customer to Globtek terms and conditions, which supersede all other agreements, terms, and conditions (<http://en.globtek.com/terms-and-conditions/>).

Footnote:

GlobTek Inc. will not be liable for the safety and performance of these power supplies if unauthorized access and repair occurs. End user should consult applicable UL, CSA or EN standards for proper installation instruction.

Limitation of Use:

GlobTek product are not authorized for use as mission critical components in life support hazardous environment, nuclear or aircraft applications without prior written approval from the CEO of GlobTek Inc.

Contents of this document are subject to change without prior notice.

GT-46120-1212, 12W, 12V@1A, Wall Plug-in, Regulated Switchmode AC-DC Power Supply AC Adaptor

GlobTek, Inc. www.globtek.com 186 Veterans Drive, Northvale, NJ 07647 Tel. (201) 784-1000 Fax (201) 784-0111	Drawing Title: GT-46120-1212, ITE Power Supply, Efficiency Level: VI, Case Color/Style: GlobTek Black, Wall Plug-in, Regulated Switchmode AC-DC Power Supply AC Adaptor, Input Rating: 100-240V~, 50-60 Hz, Interchangeable Blades http://en.globtek.com/interchangeable-blades.php , Output Rating: 12W, 12V@1A, Output Configuration: 1230 mm, 18/1C + Shield Cond, UL 1185, Female Barrel 5.5*2.1*11mm w/ Spring Clip & Locking Notch or Equal, Ferrite: None, GlobTek Black, GT Cord # C2916, Pin Out: Center Positive (+V), Blades/Input Cord: Q-Series N. American, Approvals: 230V CoC Tier 2 WEEE VCCI Ukraine RoHS EAC Level VI Double Insulation China RoHS CE PSE	
	Model No. GT-46120-1212	
	Part No./Ordering No. WR9QE1000CCPNA-N(R6B)	Rev B

POWER SUPPLY INFORMATION

TYPE: Wall Plug-in
TECHNOLOGY: Regulated Switchmode AC-DC Power Supply AC Adaptor
CASE COLOR: GlobTek Black
NAMEPLATE RATED INPUT: 100-240V~, 50-60 Hz, 0.6A
INPUT CONFIG: Interchangeable Blades
WATTS: 12.0
VOLTS OUT: 12
CURRENT OUT (Amps): 1
BLADE/CORD INCLUDED: Q-NA(R):
BLADE/CORD INSTALLED: Q-NA(R):
GROUNDING CONFIGURATION (F1) Class II / Double Insulated
EFFICIENCY LEVEL: VI
OUTPUT CONFIGURATION 1230 mm, 18/1C + Shield Cond, UL 1185, Female Barrel 5.5*2.1*11mm w/ Spring Clip & Locking Notch or Equal,
CONNECTOR PIN OUT: Ferrite: None, GlobTek Black, GT Cord # C2916
Label Specs: Center Positive (+V)
Label Specs: Standard GT,L-1186
PACK SPEC: Standard WPI, Individually Box

Notes/Modifications/Customizations (notes in this section supersede the values shown in the standard spec):

DIMENSIONS ARE IN MM UNLESS SPECIFIED OTHERWISE.

GlobTek, Inc. www.globtek.com 186 Veterans Drive, Northvale, NJ 07647 Tel. (201) 784-1000 Fax (201) 784-0111	Drawing Title: GT-46120-1212, ITE Power Supply, Efficiency Level: VI, Case Color/Style: GlobTek Black, Wall Plug-in, Regulated Switchmode AC-DC Power Supply AC Adaptor, Input Rating: 100-240V~, 50-60 Hz, Interchangeable Blades http://en.globtek.com/interchangeable-blades.php , Output Rating: 12W, 12V@1A, Output Configuration: 1230 mm, 18/1C + Shield Cond, UL 1185, Female Barrel 5.5*2.1*11mm w/ Spring Clip & Locking Notch or Equal, Ferrite: None, GlobTek Black, GT Cord # C2916, Pin Out: Center Positive (+V), Blades/Input Cord: Q-Series N. American, Approvals: 230V CoC Tier 2 WEEE VCCI Ukraine RoHS EAC Level VI Double Insulation China RoHS CE PSE	
	Model No. GT-46120-1212	
	Part No./Ordering No. WR9QE1000CCPNA-N(R6B)	Rev B

ELECTRICAL SPECIFICATIONS

A) ELECTRICAL SPECIFICATIONS:

01. Input Voltage: Specified 90-264 Vac, Nameplate rated: 100-240Vac
02. Input Frequency: Specified 47-63 Hz, Nameplate rated 50-60Hz
03. Output Regulation: +/- 5% measured at the output connector
04. Line Voltage Regulation: +/- 1% typical measured at the output connector
05. Average Efficiency: 82.96% Min (CEC & DOE LEVEL VI Compliant); 83.26% Min (ErP **European** Commission's Ecodesign Directive (2005/32/EC) / CoC Tier 2 Compliant)
06. Input Power(no load): <0.1W (CEC & DOE Level VI Compliant); <0.075W ErP **European** Commission's Ecodesign Directive (2005/32/EC) / CoC Tier 2 Compliant)
07. Output Ripple (Vp-p): +/-1% or 150 mV whichever is greater, measured at 20 MHz bandwidth with 0.1 uf ceramic capacitor in parallel with 10 uf electrolytic capacitor connected at the end of the output connector at nominal line
08. Turn-ON/OFF Overshoot: 5% maximum, 1 mS typical recovery time for 25% step load
09. Turn-ON Delay: 1 Sec, typical
10. Hold-Up Time: 8 mS typical at nominal input voltage and full load
11. Inrush Current: 30A typical at 115VAC input ; 60A typical at 230VAC input
12. Switching Frequency: 65 KHz typical

B) PROTECTION

01. Over-Voltage: Protected Zener clamp across the output
02. Short Circuit: Protected unit will auto recover upon removal of fault
03. Input Protection: Input line fusing

C) SAFETY

01. Dielectric Withstand Voltage: 4242Vdc from primary to secondary
02. Touch Current: <0.25mA @ 240Vac input voltage

D) OTHER:

01. MTBF: 200,000 Hours @ 25°C ambient temperature
02. Operating Temperature: 0°C to 40°C ambient temperature
03. Humidity: 0% to 90% relative humidity
04. Storage Temperature: -10°C to 80°C
05. Cooling: Convection

E) ENCLOSURE

01. Housing: High impact plastic, 94V0 polycarbonate, non-vented
02. Size: 64.0*40.5*31.5 +/-1.0 mm
03. Markings: Label and/or Pad Printed and/or Molded in the case

GlobTek, Inc.
 www.globtek.com
 186 Veterans Drive,
 Northvale, NJ 07647
 Tel. (201) 784-1000
 Fax (201) 784-0111

Drawing Title: GT-46120-1212, ITE Power Supply, Efficiency Level: VI, Case Color/Style: GlobTek Black, Wall Plug-in, Regulated Switchmode AC-DC Power Supply AC Adaptor, Input Rating: 100-240V~, 50-60 Hz, Interchangeable Blades <http://en.globtek.com/interchangeable-blades.php>, Output Rating: 12W, 12V@1A, Output Configuration: 1230 mm, 18/1C + Shield Cond, UL 1185, Female Barrel 5.5*2.1*11mm w/ Spring Clip & Locking Notch or Equal, Ferrite: None, GlobTek Black, GT Cord # C2916, Pin Out: Center Positive (+V), Blades/Input Cord: Q-Series N. American, Approvals: 230V CoC Tier 2 WEEE VCCI Ukraine RoHS EAC Level VI Double Insulation China RoHS CE PSE

Model No. GT-46120-1212

Part No./Ordering No. WR9QE1000CCPNA-N(R6B)

Rev B

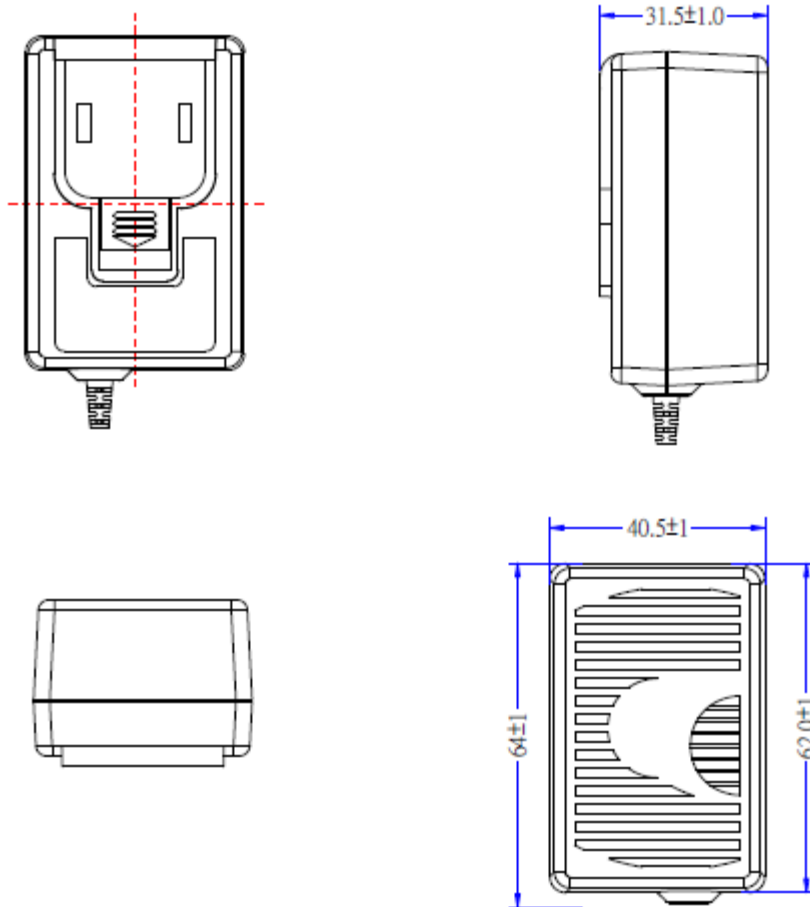

DERATING CURVE

GlobTek, Inc.
 www.globtek.com
 186 Veterans Drive,
 Northvale, NJ 07647
 Tel. (201) 784-1000
 Fax (201) 784-0111

Drawing Title: GT-46120-1212, ITE Power Supply, Efficiency Level: VI, Case Color/Style: GlobTek Black, Wall Plug-in, Regulated Switchmode AC-DC Power Supply AC Adaptor, Input Rating: 100-240V~, 50-60 Hz, Interchangeable Blades <http://en.globtek.com/interchangeable-blades.php>, Output Rating: 12W, 12V@1A, Output Configuration: 1230 mm, 18/1C + Shield Cond, UL 1185, Female Barrel 5.5*2.1*11mm w/ Spring Clip & Locking Notch or Equal, Ferrite: None, GlobTek Black, GT Cord # C2916, Pin Out: Center Positive (+V), Blades/Input Cord: Q-Series N. American, Approvals: 230V CoC Tier 2 WEEE VCCI Ukraine RoHS EAC Level VI Double Insulation China RoHS CE PSE

Model No. GT-46120-1212

Part No./Ordering No. WR9QE1000CCPNA-N(R6B)

Rev B

Typical External Power Supply Derating Curve

(For Efficiency Level V and Efficiency Level VI Products)

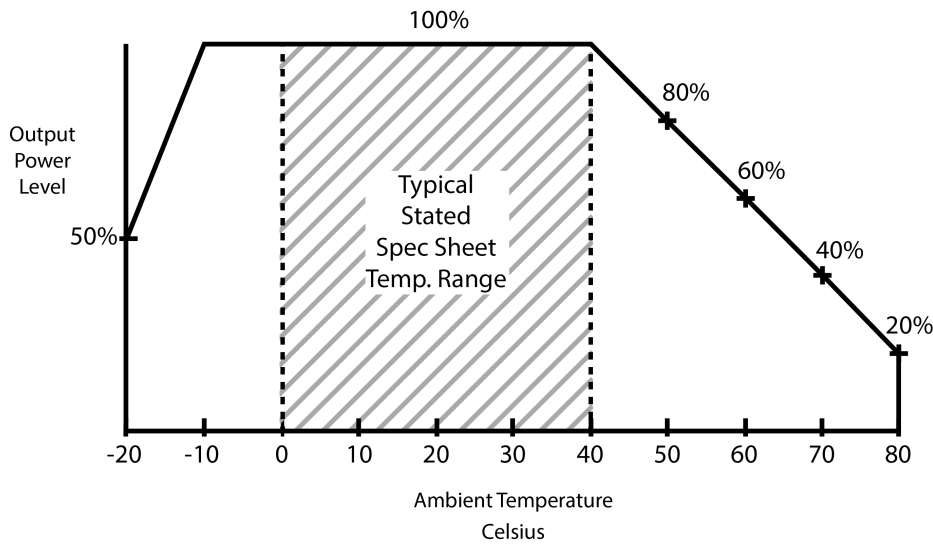

GlobTek, Inc. www.globtek.com 186 Veterans Drive, Northvale, NJ 07647 Tel. (201) 784-1000 Fax (201) 784-0111	Drawing Title: GT-46120-1212, ITE Power Supply, Efficiency Level: VI, Case Color/Style: GlobTek Black, Wall Plug-in, Regulated Switchmode AC-DC Power Supply AC Adaptor, Input Rating: 100-240V~, 50-60 Hz, Interchangeable Blades http://en.globtek.com/interchangeable-blades.php , Output Rating: 12W, 12V@1A, Output Configuration: 1230 mm, 18/1C + Shield Cond, UL 1185, Female Barrel 5.5*2.1*11mm w/ Spring Clip & Locking Notch or Equal, Ferrite: None, GlobTek Black, GT Cord # C2916, Pin Out: Center Positive (+V), Blades/Input Cord: Q-Series N. American, Approvals: 230V CoC Tier 2 WEEE VCCI Ukraine RoHS EAC Level VI Double Insulation China RoHS CE PSE	
	Model No. GT-46120-1212	
	Part No./Ordering No. WR9QE1000CCPNA-N(R6B)	Rev B

INPUT CONFIGURATION

Grounding Configuration:

Blades/Cord Included: Q-NA(R):

Blades/Cord Installed: Q-NA(R):

Blade Options for Q Series Wall Plug-in Power Supplies

Data Sheet: <http://en.globtek.com/interchangeable-blades.php>

Insertion Instructions: <http://www.globtek.com/pdf/Instructions-Interchangeable-Blades.pdf>

Video: [Q-Blade Style Instruction Video](#)

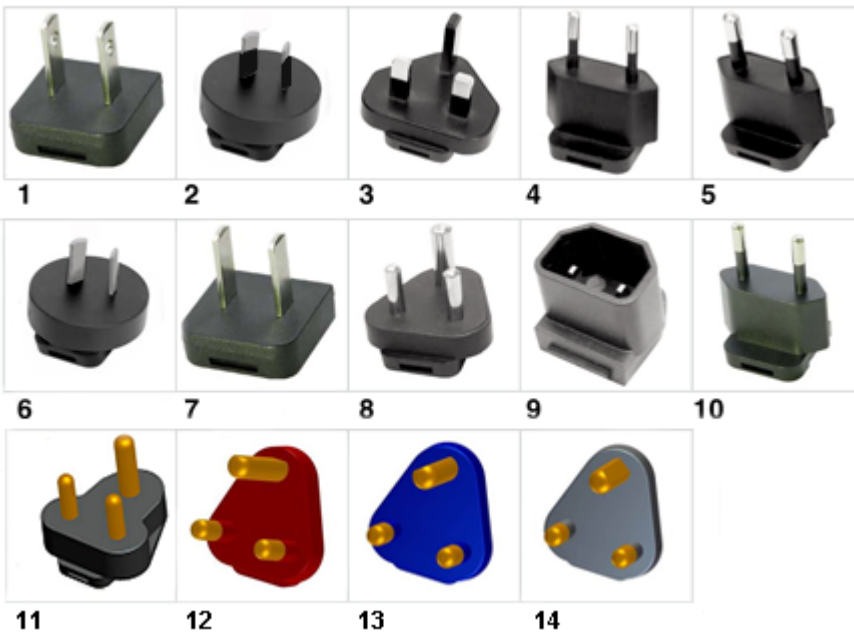

INPUT CONNECTOR: Q-Socket (below are available blades configurations which are "not included" (unless stated above); can be purchased separately, package with power supply or as a separate "Q-KIT" if specified

01. United States / Canada / Japan NEMA 1-15P configuration: NA 2 blades, Class II; US/CA/JP P/N: Q-NA(R)
02. Australian AS 3112 configuration: SAA 2 blade, Class II; AU P/N: Q-SAA(R)
03. UK BS 1363 configuration: UK 3 blade with dummy Ground, Class II; GB P/N: Q-UK(R)
04. European CEE 7/16 configuration: Europlug 2 pins, Class II; EU P/N: Q-EU(R)
05. Korean KS C8305 configuration: 2 pins, Class II; KR P/N: Q-KR(R)
06. Argentina IRAM 2073 configuration: 2 blades; AR P/N: Class II Q-AR(R)
07. China GB 2099 configuration: 2 blades, Class II; CN P/N: Q-CN(R)
08. India IS 1293 6A/BS546 configuration: 5A, 3 pins with Dummy Ground, Class II; IN P/N: Q-IN(R)
09. IEC320/C18 Inlet, Class II; P/N: Q-C18(R)
10. Brazilian NBR6147 configuration: 2 pins, Class II; BR P/N: Q-BR(R)
11. South Africa SABS164-1, 3 round prongs, Class II + dummy ground, P/N: Q-SANS164-1-16A(R)
12. South Africa SABS164-4, 3 round prongs with a notched prong @ 0°, Class II + dummy ground, Red, P/N: Q-SANS164-4L-16A(R)
13. South Africa SABS164-4, 3 round prongs with a notched prong @ -53°, Class II + dummy ground, Blue, P/N:

PROPRIETARY INFORMATION

PROPRIETARY OF GLOBTEK, INC. ANY REPRODUCTION, DISCLOSURE OR USE OF THIS DRAWING, IN WHOLE OR IN PART, IS HEREBY PROHIBITED EXCEPT AS SPECIFIED IN WRITING BY GLOBTEK, INC.

quest /08/20/2018 7:42:37 AM

GlobTek, Inc. www.globtek.com 186 Veterans Drive, Northvale, NJ 07647 Tel. (201) 784-1000 Fax (201) 784-0111	Drawing Title: GT-46120-1212, ITE Power Supply, Efficiency Level: VI, Case Color/Style: GlobTek Black, Wall Plug-in, Regulated Switchmode AC-DC Power Supply AC Adaptor, Input Rating: 100-240V~, 50-60 Hz, Interchangeable Blades http://en.globtek.com/interchangeable-blades.php , Output Rating: 12W, 12V@1A, Output Configuration: 1230 mm, 18/1C + Shield Cond, UL 1185, Female Barrel 5.5*2.1*11mm w/ Spring Clip & Locking Notch or Equal, Ferrite: None, GlobTek Black, GT Cord # C2916, Pin Out: Center Positive (+V), Blades/Input Cord: Q-Series N. American, Approvals: 230V CoC Tier 2 WEEE VCCI Ukraine RoHS EAC Level VI Double Insulation China RoHS CE PSE	
	Model No. GT-46120-1212	
	Part No./Ordering No. WR9QE1000CCPNA-N(R6B	Rev B

Q-SANS164-4C-16A(R)

14. South Africa SABS164-4, 3 round prongs with a notched prong @ +53°, Class II + dummy ground, Black, P/N:

Q-SANS164-4R-16A(R)

Kits

- 01. Q-KIT: 1,2,3,4 above
- 02. Q-KIT-INTL: 2,3,4 above
- 03. Q-KIT-6: 1,2,3,4,5,6 above
- 04. Q-KIT-7: 1,2,3,4,5,6,7 above
- 05. Q-KIT-8: 1,2,3,4,5,6,7,8 above

GlobTek, Inc. www.globtek.com 186 Veterans Drive, Northvale, NJ 07647 Tel. (201) 784-1000 Fax (201) 784-0111	Drawing Title: GT-46120-1212, ITE Power Supply, Efficiency Level: VI, Case Color/Style: GlobTek Black, Wall Plug-in, Regulated Switchmode AC-DC Power Supply AC Adaptor, Input Rating: 100-240V~, 50-60 Hz, Interchangeable Blades http://en.globtek.com/interchangeable-blades.php , Output Rating: 12W, 12V@1A, Output Configuration: 1230 mm, 18/1C + Shield Cond, UL 1185, Female Barrel 5.5*2.1*11mm w/ Spring Clip & Locking Notch or Equal, Ferrite: None, GlobTek Black, GT Cord # C2916, Pin Out: Center Positive (+V), Blades/Input Cord: Q-Series N. American, Approvals: 230V CoC Tier 2 WEEE VCCI Ukraine RoHS EAC Level VI Double Insulation China RoHS CE PSE	
	Model No. GT-46120-1212	
	Part No./Ordering No. WR9QE1000CCPNA-N(R6B)	Rev B

OUTPUT CORD AND CONNECTOR: CL1/C2916

ACTUAL CONNECTORS, OVERMOLDS, FERRITES MAY VARY SLIGHTLY FROM THE PICTURE BELOW

CABLE TYPE	UL 1185
CABLE LENGTH (mm)	1230
CABLE TOLERANCE (mm)	+150 -0
WIRE GAUGE (AWG)	18
CONDUCTORS	1C + Shield
HANK DIMENSION (mm)	70 ±10
CABLE / CONNECTOR OVERMOLD COLOR	GlobTek Black
FERRITE TYPE / DIMENSION	None
FERRITE # OF TURNS (Definition)	N/A
FERRITE DIMENSION FROM STRAIN RELIEF	N/A
FERRITE DIMENSION FROM PLUG	N/A
PLUG TYPE	Female Barrel 5.5*2.1*11mm w/ Spring Clip & Locking Notch or Equal
OVER MOLD ORIENTATION	Straight
CONNECTOR PIN OUT:	Center Positive (+V)
ADDITIONAL REQUIREMENTS	

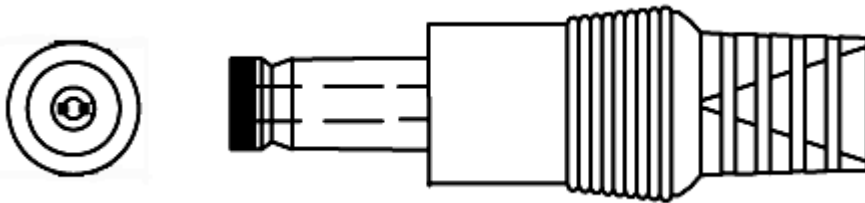

ADDITIONAL OUTPUT PLUG OPTIONS ARE

AVAILABLE AT <http://www.globtek.com/connectors/>

STANDARD PLUGS AND CONNECTORS CAN BE SEEN ONLINE AT <http://www.globtek.com/connectors/>

GlobTek, Inc. www.globtek.com 186 Veterans Drive, Northvale, NJ 07647 Tel. (201) 784-1000 Fax (201) 784-0111	Drawing Title: GT-46120-1212, ITE Power Supply, Efficiency Level: VI, Case Color/Style: GlobTek Black, Wall Plug-in, Regulated Switchmode AC-DC Power Supply AC Adaptor, Input Rating: 100-240V~, 50-60 Hz, Interchangeable Blades http://en.globtek.com/interchangeable-blades.php , Output Rating: 12W, 12V@1A, Output Configuration: 1230 mm, 18/1C + Shield Cond, UL 1185, Female Barrel 5.5*2.1*11mm w/ Spring Clip & Locking Notch or Equal, Ferrite: None, GlobTek Black, GT Cord # C2916, Pin Out: Center Positive (+V), Blades/Input Cord: Q-Series N. American, Approvals: 230V CoC Tier 2 WEEE VCCI Ukraine RoHS EAC Level VI Double Insulation China RoHS CE PSE	
	Model No. GT-46120-1212	
	Part No./Ordering No. WR9QE1000CCPNA-N(R6B)	Rev B

LABEL:L-1186

LABEL P/N: Standard GT
MATERIAL: Flat Thermal Transfer, Imprintable, Polyester Label and/or Pad Printed and/or Molded, and/or Laser Engraved in the case
BACKGROUND COLOR: Black if housing is Black, White or Silver if housing is White or Gray.
TEXT COLOR: White or Silver if label is Black Background for Black housing. Black if label is White or Silver background and Housing is White or Gray
LABEL WIDTH (mm): 29.8
LABEL HEIGHT (mm): 20.8

Below is the minimum information which will appear on the label. NOTE: in the logo area additional/actual positioning of symbols and text is subjected to change as per agency updates/requirements or additional model approvals become available.
 Regulatory certifications/label markings may be in logo area on the label or molded into the case housing outside the label area.
 Information will be shown via label and/or pad printed and/or molded and/or laser engraved in the case. * Date code markings at GlobTek option.

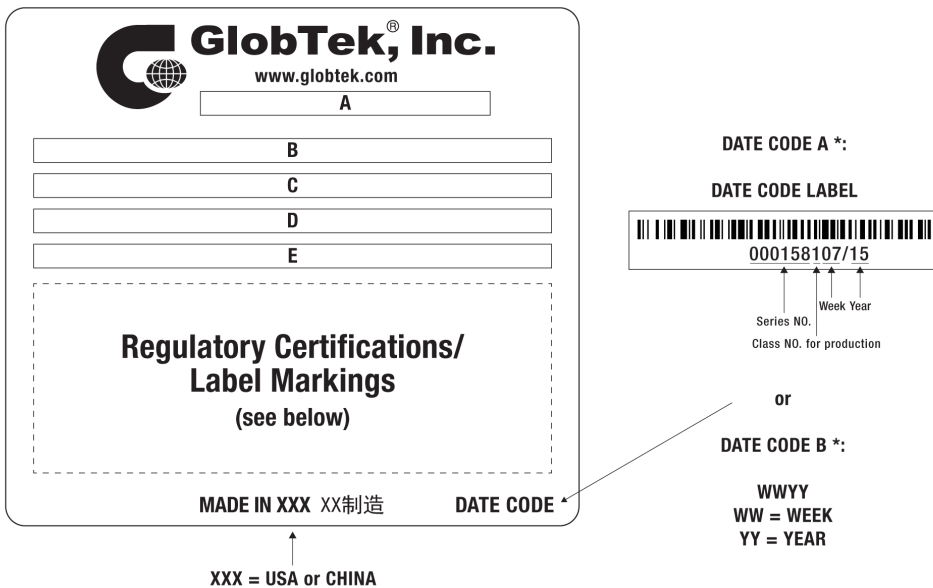

A=ITE Power Supply
 B=P/N: (料号) WR9QE1000CCPNA-N(R6B)
 C=Model (型号) GT-46120-1212
 D=Input (输入) 100-240V~, 50-60 Hz, 0.6A
 E=Output (输出) 12 V 1 A ,12.0W

- AGENCY ONLINE DOCUMENTS <http://www.globtek.info/certs/GT-46120-WWVV/>
- CE EC-Declaration for Medical [Contact GlobTek for more information](#)
- CE EC-Declaration for Industrial/Commercial/ITE http://www.globtek.com/pdf/ec_declaration/a0Oa000000Nrw14EAB
- RoHS/RoHS2 Declaration http://www.globtek.com/pdf/rohs_cert/01ta0000007dRJ0AAM
- REACH Declaration http://www.globtek.com/pdf/iso_certificates/REACH.pdf

GlobTek, Inc. www.globtek.com 186 Veterans Drive, Northvale, NJ 07647 Tel. (201) 784-1000 Fax (201) 784-0111	Drawing Title: GT-46120-1212, ITE Power Supply, Efficiency Level: VI, Case Color/Style: GlobTek Black, Wall Plug-in, Regulated Switchmode AC-DC Power Supply AC Adaptor, Input Rating: 100-240V~, 50-60 Hz, Interchangeable Blades http://en.globtek.com/interchangeable-blades.php , Output Rating: 12W, 12V@1A, Output Configuration: 1230 mm, 18/1C + Shield Cond, UL 1185, Female Barrel 5.5*2.1*11mm w/ Spring Clip & Locking Notch or Equal, Ferrite: None, GlobTek Black, GT Cord # C2916, Pin Out: Center Positive (+V), Blades/Input Cord: Q-Series N. American, Approvals: 230V CoC Tier 2 WEEE VCCI Ukraine RoHS EAC Level VI Double Insulation China RoHS CE PSE	
	Model No. GT-46120-1212	
	Part No./Ordering No. WR9QE1000CCPNA-N(R6B)	Rev B

Conflict Minerals Declaration

<http://www.globtek.com/pdf/conflict-minerals.pdf>

IPXY rating is based on 3rd party testing and customers should check suitability and test system level IPXY rating before ordering.

Regulatory Certifications/Label Markings

LATEST PRODUCT/MODEL CERTIFICATIONS: <http://en.globtek.com/datasheet/id/a0Oa000000Nrw14>

AGENCY ONLINE DOCUMENTS: <http://www.globtek.info/certs/GT-46120-WVVV/>

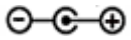

Center Positive (+V)

GlobTek, Inc.
www.globtek.com
186 Veterans Drive,
Northvale, NJ 07647
Tel. (201) 784-1000
Fax (201) 784-0111

Drawing Title: GT-46120-1212, ITE Power Supply, Efficiency Level: VI, Case Color/Style: GlobTek Black, Wall Plug-in, Regulated Switchmode AC-DC Power Supply AC Adaptor, Input Rating: 100-240V~, 50-60 Hz, Interchangeable Blades <http://en.globtek.com/interchangeable-blades.php>, Output Rating: 12W, 12V@1A, Output Configuration: 1230 mm, 18/1C + Shield Cond, UL 1185, Female Barrel 5.5*2.1*11mm w/ Spring Clip & Locking Notch or Equal, Ferrite: None, GlobTek Black, GT Cord # C2916, Pin Out: Center Positive (+V), Blades/Input Cord: Q-Series N. American, Approvals: 230V CoC Tier 2 WEEE VCCI Ukraine RoHS EAC Level VI Double Insulation China RoHS CE PSE

Model No. GT-46120-1212

Part No./Ordering No. WR9QE1000CCPNA-N(R6B)

Rev B

PACKAGING

Packing Spec P/N: Standard WPI, Individually
Box

Box Qty: 80

Gift Box Size (mm): 90.5*73*53

Gift Box Color: White

Master Carton Size (mm): 388*380*245

Master GW (Kg): 15.4 kg

BLADES INCLUDED: Q-NA(R):

BLADE/CORD INSTALLED: Q-NA(R):

If specific packaging is required, this section must specify all requirements and note "no exceptions". If this section does not specify packaging, it is subject to change without notice at GlobTek's discretion

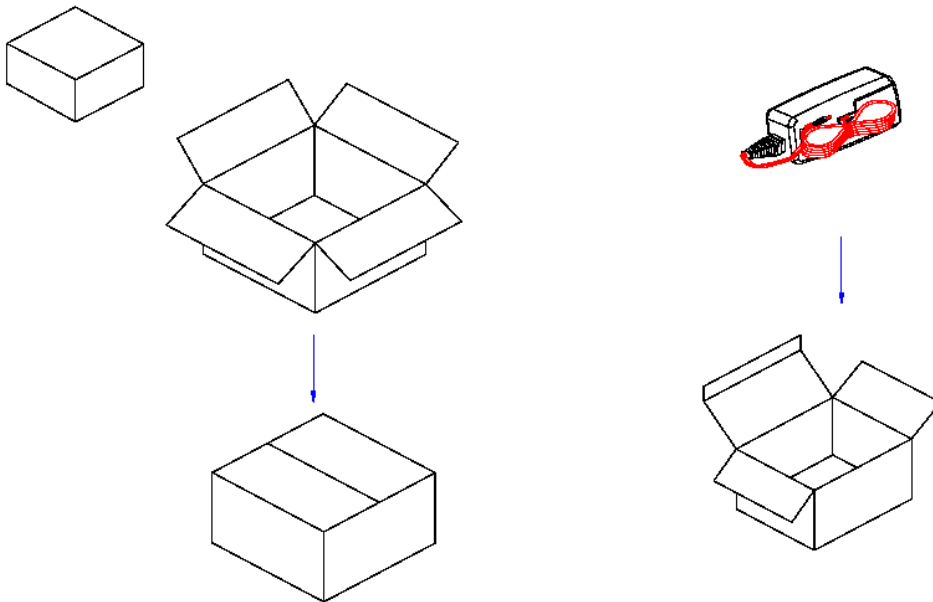

GlobTek, Inc. www.globtek.com 186 Veterans Drive, Northvale, NJ 07647 Tel. (201) 784-1000 Fax (201) 784-0111	Drawing Title: GT-46120-1212, ITE Power Supply, Efficiency Level: VI, Case Color/Style: GlobTek Black, Wall Plug-in, Regulated Switchmode AC-DC Power Supply AC Adaptor, Input Rating: 100-240V~, 50-60 Hz, Interchangeable Blades http://en.globtek.com/interchangeable-blades.php , Output Rating: 12W, 12V@1A, Output Configuration: 1230 mm, 18/1C + Shield Cond, UL 1185, Female Barrel 5.5*2.1*11mm w/ Spring Clip & Locking Notch or Equal, Ferrite: None, GlobTek Black, GT Cord # C2916, Pin Out: Center Positive (+V), Blades/Input Cord: Q-Series N. American, Approvals: 230V CoC Tier 2 WEEE VCCI Ukraine RoHS EAC Level VI Double Insulation China RoHS CE PSE	
	Model No. GT-46120-1212	
	Part No./Ordering No. WR9QE1000CCPNA-N(R6B)	Rev B

INSTRUCTION SHEET

Q Blades Instruction Sheet (not required to be packaged with product)

Insertion Instructions: <http://www.globtek.com/pdf/Instructions-Interchangeable-Blades.pdf>

This manual is Provided to customer within the product specification - it is the responsibility of

the OEM/customer to provide the end system user instructions + warnings for the use of this product in the end system. By accepting this specification the customer/OEM Agrees to these terms.

USER MANUAL FOR Q-BLADE SERIES SWITCHING POWER SUPPLIES

Manual del Usuario. Fuentes de Alimentación Series Q-Blade

WARNING! RISK OF FIRE! SHOCK HAZARD!: To prevent electric shock, do not remove the cover. No user-serviceable parts inside. This unit contains hazardous voltages and should only be opened by a trained and qualified technician. Do not use if bent, cracked, modified or compromised. To avoid the possibility of electric shock, disconnect electric power to the product before connecting or disconnecting.

Advertencia! Riesgo de Fuego! Peligro de Choque eléctrico!

No contiene dentro componentes servibles para el usuario. Desconecte el cable de alimentación antes de quitar la cubierta.

INDOOR USE ONLY!

Únicamente para uso en el interior.

POWER SUPPLY BLADE/CORD: AC Mains voltage should be provided to the power supply by a power supply cords approved to

the national standards in which it will be used. Please use the below table as a guideline for Suitable Power cords.

CABLE DE ALIMENTACIÓN: El voltaje de la CA debe proporcionarse a la fuente de alimentación mediante

los cables de alimentación aprobados conforme a las normas nacionales según las cuales será utilizada. Utilice por favor la tabla mencionada aquí abajo como guía para los cables eléctricos adecuados.

1. Class II model NEMA 1-15P AC power plug with 2 prongs, Q-NA(R)
2. Australian AS 3112 configuration: SAA 2 pins Class II, Q-SAA(R)
3. UK BS 1363 configuration: UK 2 pins Class II, Q-UKY(R)
4. European CEE 7/16 configuration: Europlug 2 PINS, Class II, Q-EU(R)
5. Korean KS C8305 configuration: Q-KR(R)
6. Argentina IRAM 2073 configuration: 2 pins, Class II Q-AR(R)
7. China GR 2099 configuration: 2 pins, Class II Q-CN(R)
8. India configuration: 2 pins, Class II, Q-IN(R)
9. IEC320/C18 Inlet

FUSING: Internal fuse for Line is provided in the power supply. A blown internal fuse is an indication of catastrophic failure

GlobTek, Inc.
www.globtek.com
186 Veterans Drive,
Northvale, NJ 07647
Tel. (201) 784-1000
Fax (201) 784-0111

Drawing Title: GT-46120-1212, ITE Power Supply, Efficiency Level: VI, Case Color/Style: GlobTek Black, Wall Plug-in, Regulated Switchmode AC-DC Power Supply AC Adaptor, Input Rating: 100-240V~, 50-60 Hz, Interchangeable Blades <http://en.globtek.com/interchangeable-blades.php>, Output Rating: 12W, 12V@1A, Output Configuration: 1230 mm, 18/1C + Shield Cond, UL 1185, Female Barrel 5.5*2.1*11mm w/ Spring Clip & Locking Notch or Equal, Ferrite: None, GlobTek Black, GT Cord # C2916, Pin Out: Center Positive (+V), Blades/Input Cord: Q-Series N. American, Approvals: 230V CoC Tier 2 WEEE VCCI Ukraine RoHS EAC Level VI Double Insulation China RoHS CE PSE

Model No. GT-46120-1212

Part No./Ordering No. WR9QE1000CCPNA-N(R6B)

Rev B

of circuit component(s). Repair must be performed by GlobTek, Inc. authorized personnel. Fuses must be replaced with same type and ratings per GlobTek internal documentation.

FUSIBLES: La fuente de alimentación provee un fusible interno para la línea. Un fusible interno quemado es un indicador de una falla catastrófica de los componentes del circuito. La reparación debe ser hecha por personal autorizado de GlobTek, Inc. Los fusibles se deben reemplazar por los mismos tipos y rangos que la documentación interna de GlobTek mencione.

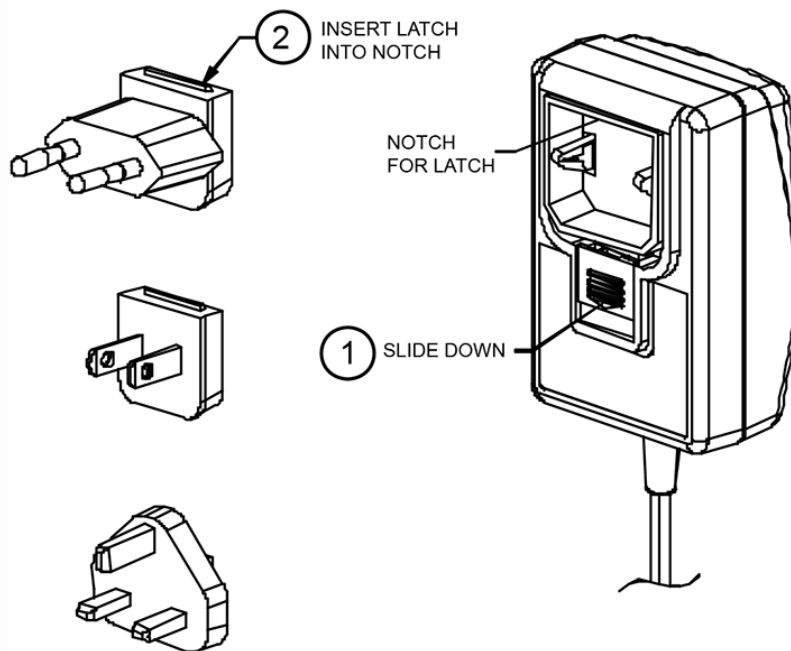

This symbol on an instrument indicates that the user should refer to the operating instructions located in the manual.