

## Evaluation Board for Fractional-N/Integer-N PLL Frequency Synthesizer

### FEATURES

**Self-contained board including PLL, VCO, loop filter (3 kHz),  
USB interface, and voltage regulators**

**Accompanying software allows control of synthesizer  
functions from a PC**

**Choice of power supply via USB or external feeding**

**Typical phase noise performance of  $-111$  dBc/Hz @ 100 kHz  
offset from carrier (6.8 GHz output frequency)**

### GENERAL DESCRIPTION

The EV-ADF5355SD1Z is designed to evaluate the performance of the ADF5355 frequency synthesizer. A digital picture of the board is shown in Figure 1. It contains the ADF5355

synthesizer, a USB connector and related interface, SMA connectors for the RF outputs, and reference signal plus headers for various signals and voltages. There is also a loop filter (5 kHz) on board. An SDP-S connector is required to operate the board, this is ordered separately.

The package also contains Windows® software (XP, Vista-and Windows 7 compatible) to allow easy programming of the synthesizer.

### EVALUATION KIT CONTENTS

**Evaluation board software CD**

**USB cable**

**EV-ADF5355SD1Z**

### DIGITAL PICTURE OF EVALUATION BOARD

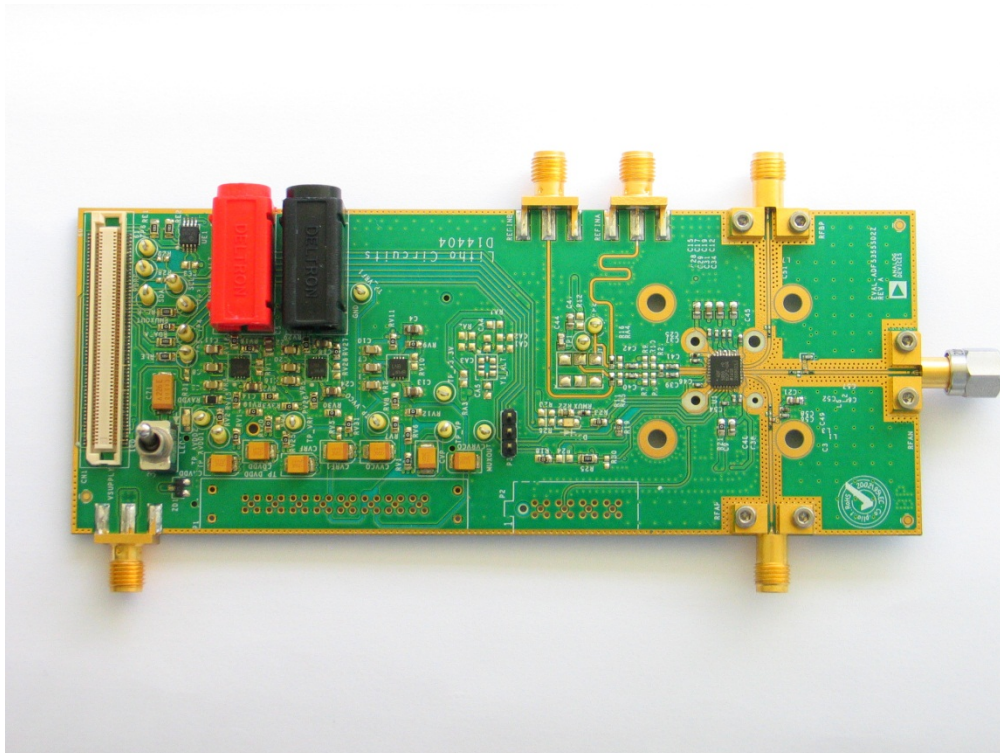

Figure 1.

## TABLE OF CONTENTS

Features .....	1	Power Supplies.....	3
General Description .....	1	RF Output.....	3
Evaluation Kit Contents.....	1	Loop Filter .....	3
Digital Picture of Evaluation Board .....	1	Reference Source .....	3
Revision History .....	2	Evaluation Set Up .....	4
Evaluation Board Hardware .....	3	Evaluation Board Software.....	5
Overview.....	3	Evaluation Board Schematics and Artwork.....	9

## REVISION HISTORY

**14/10—Revision PrC: Updated for revised components.**

**14/07—Revision PrB: Initial Preliminary Version**

    Edited description.

**14/05—Revision PrA: Initial Preliminary Version**

## EVALUATION BOARD HARDWARE

### OVERVIEW

The EV-ADF5355SD1Z requires the SPD-S platform which uses the EVAL-SDP-CS1Z. **(SDP-B is not recommended).**

### POWER SUPPLIES

The EV-ADF5355SD1Z is powered from dc power connectors (4 mm banana connectors). When feeding via banana connectors, 6.0 V is a suitable feeding voltage. The power supply circuitry allows the user to use two or three separate LDOs to feed the ADF5355 (using fewer LDOs increases the risk of spur contaminated dc feeds). Ensure the switch is in the correct position to power the board. Consult the board schematic in Figure 20, Figure 21, and Figure 22 to determine a suitable setting.

The charge pump and VCO supply pins are driven from a 5V ADM7150 high performance low noise regulator. The remaining supplies are powered from 3.3V ADM7150's.

An LED, indicates when USB power is available, and another LED, indicates when the ADF5355 is powered on. **Switch S1 is used to power the ADF5355 from the external dc connectors, and should be switched to the left.**

In case the SDP processor causes spurs on the RF output signal, the user may remove this connector and measure the spurious.

### RF OUTPUT

The EV-ADF5355SD1Z has one pair of SMA output connectors (differential outputs RFoutA+/-). The device is quite sensitive to impedance unbalance. If only one port of a differential pair is used, terminate the other with a 50  $\Omega$  load. If only RFoutB is used, then it can be powered off, or if left on, both RFoutA pins should be terminated in 50 Ohms.

The RFoutB contains the high frequency (6.8 – 13.6 GHz) and is a single ended RF output.

### LOOP FILTER

The loop filter schematic is included in the board schematic on Figure 20. The loop filter component placements are clarified in

Figure 2. Customers wishing for lowest noise at 100 kHz offset are advised to use the following components, and to use 0.9 mA charge pump current, which are inserted on the evaluation board.

C60 = 22 nF, C59 = 0.47  $\mu$ F, C14 = 10 nF, C73 = 10 pF.

R14 = 220 Ohms, R1 = 470 Ohms.

Customers wishing for lowest rms phase noise should use:

C60 = 1.2 nF, C59 = 33 nF, C14 = 390 pF, C73 = 10 pF.

R14 = 1 kOhms, R17 = 3.3 kOhm.

And also program the 0.9 mA charge pump current.

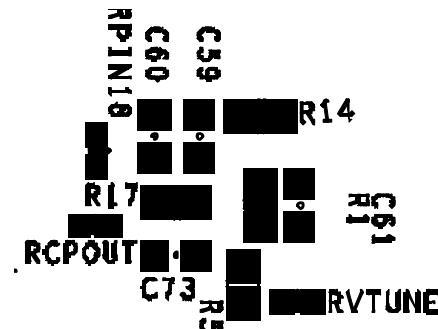

Figure 2. Loop Filter Placement

### REFERENCE SOURCE

The evaluation board contains a footprint for a 122.88 MHz differential output TCXO from Vectron. If preferred, the user may supply either a single-ended or differential reference input to connectors REFINA and REFINB. Disconnect the power rail to the TCXO by removing resistor R12 first.

To use a single ended REFIN, then connect a low noise 122.88 MHz reference source to REFINB. To use a differential REFIN connect the differential signal to REFINA and REFINB. The differential REFIN can operate to 500 MHz input frequency.

If the TCXO is removed, then an external REFIN must be used.

# EVALUATION SET UP

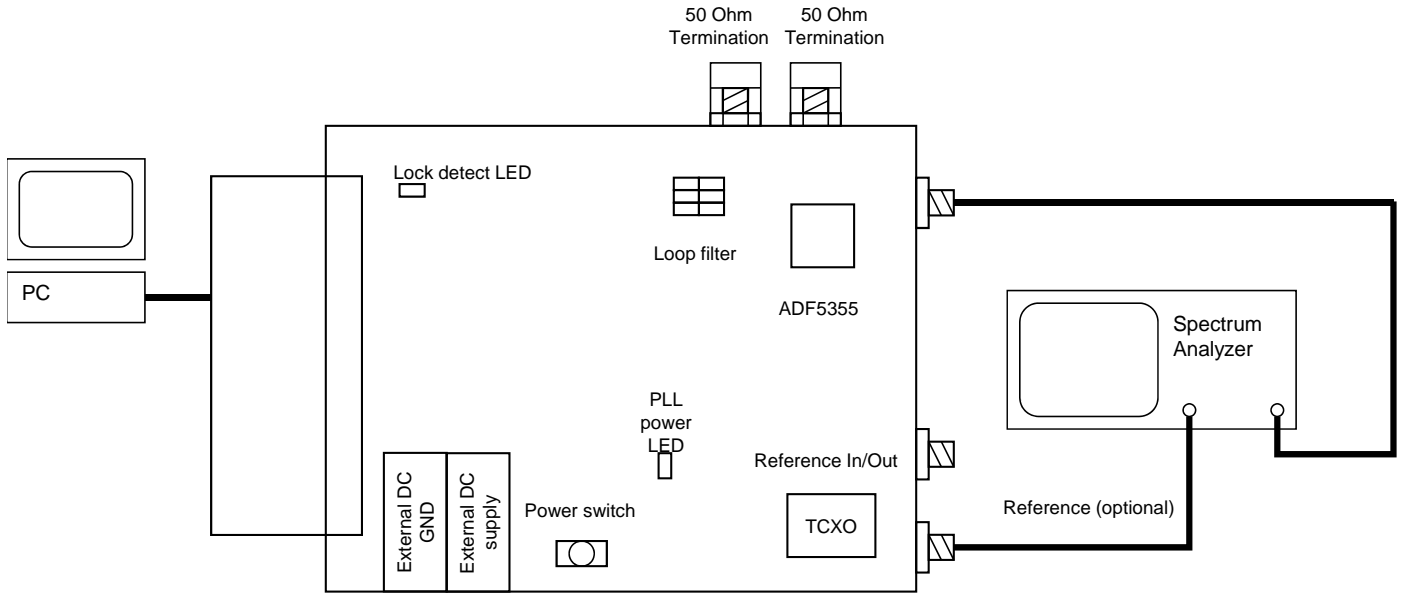

Figure 3. Evaluation Set Up

## SOFTWARE INSTALLATION

Use the following steps to install the software.

1. Install the Analog Devices ADF4355 software by double-clicking **ADF4355 Setup.msi**.  
If you are using Windows XP, follow the instructions in the Windows XP Software Installation Guide section (see Figure 4 to Figure 8).  
If you are using Windows Vista or Windows 7, follow the instructions in the Windows Vista and Windows 7 Software Installation Guide section (see Figure 9 to Figure 13).  
Note that the software requires Microsoft Windows Installer and Microsoft .NET Framework 3.5 (or higher).  
The installer connects to the Internet and downloads Microsoft .NET Framework automatically. Alternatively, before running the **ADF4355 Setup.msi**, both the installer and .NET Framework can be installed from the CD provided.
2. Connect your board by USB.  
If you are using Windows XP, follow the steps in the Windows XP Driver Installation Guide section (see Figure 14 to Figure 17).  
On Windows Vista or Windows 7, the drivers install automatically.

### Windows XP Software Installation Guide

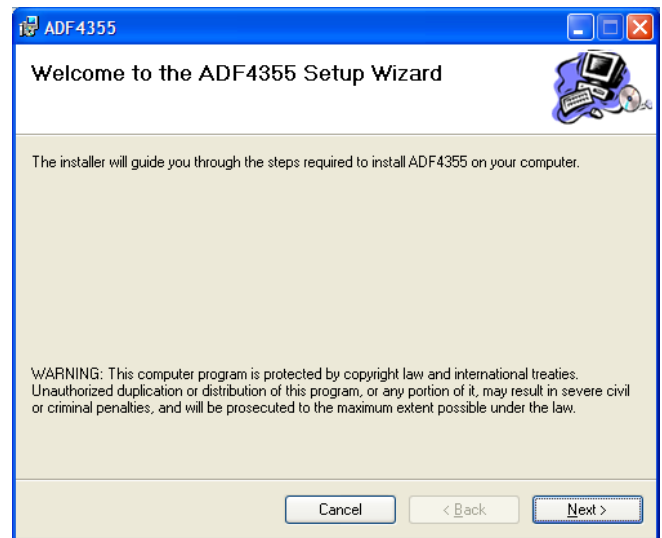

Figure 4. Windows XP ADF4355 Software Installation, Setup Wizard

1. Click **Next**.

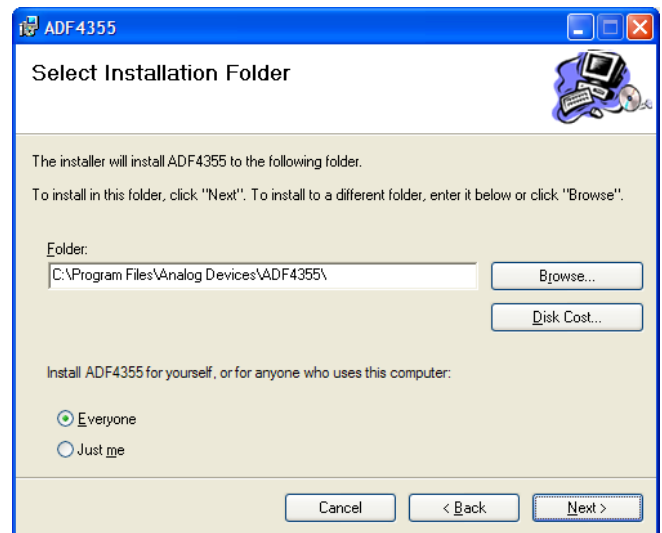

Figure 5. Windows XP ADF4355 Software Installation, Select Installation Folder

2. Choose an installation directory and click **Next**.

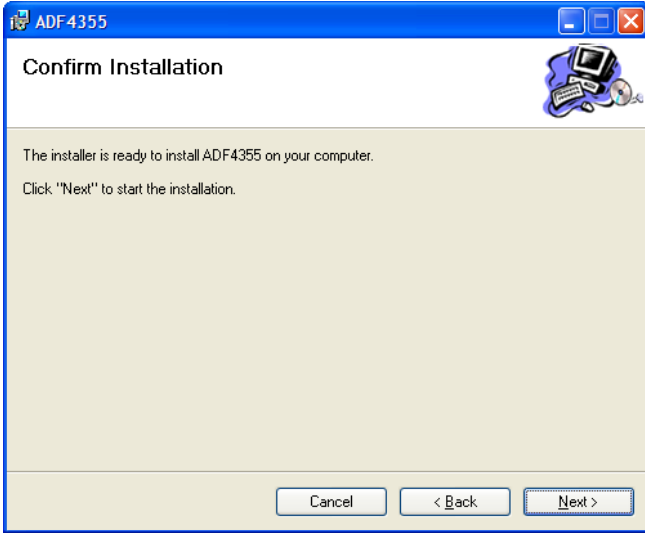

Figure 6. Windows XP ADF4355 Software Installation, Confirm Installation

3. Click **Next**.



Figure 7. Windows XP ADF4355 Software Installation, Logo Testing

4. Click **Continue Anyway**.

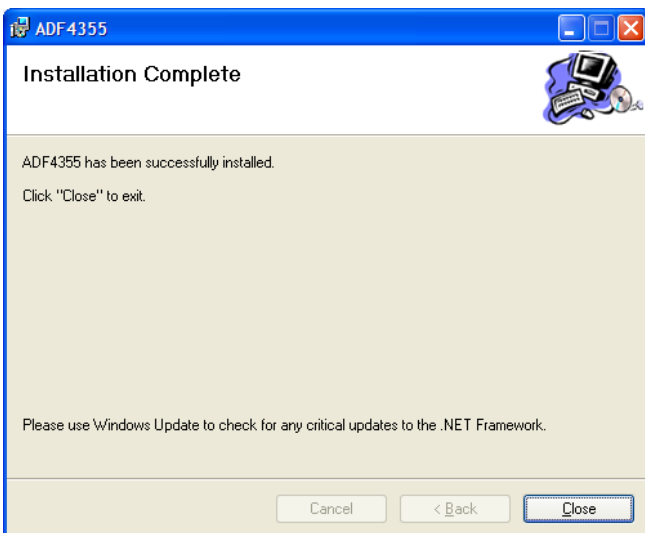

Figure 8. Windows XP ADF4355 Software Installation, Installation Complete

5. Click **Close**.

**Windows Vista and Windows 7 Software Installation Guide**



Figure 9. Windows Vista/7 ADF4355 Software Installation, Setup Wizard

1. Click **Next**.

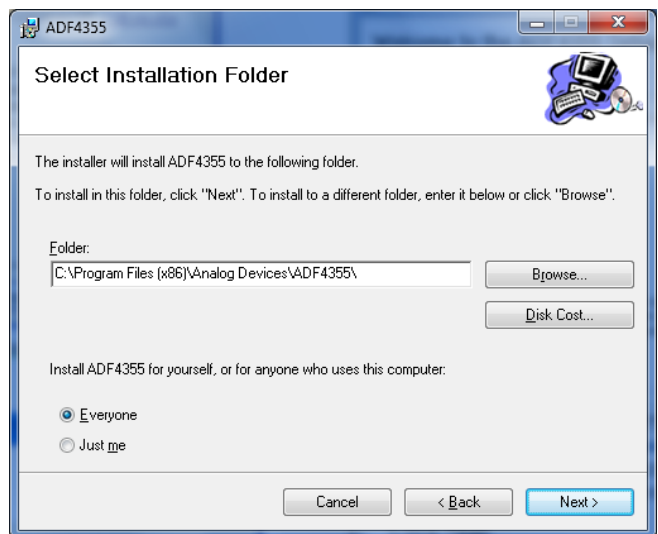

Figure 10. Windows Vista/7 ADF4355 Software Installation, Select Installation Folder

2. Choose an installation directory and click **Next**.

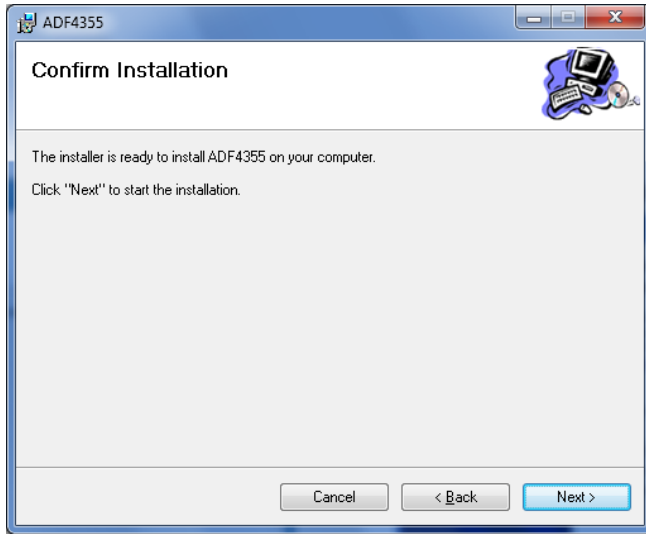

Figure 11. Windows Vista/7 ADF4355 Software Installation, Confirm Installation

3. Click **Next**.



Figure 12. Windows Vista/7 ADF4355 Software Installation, Start Installation

4. Click **Install**.

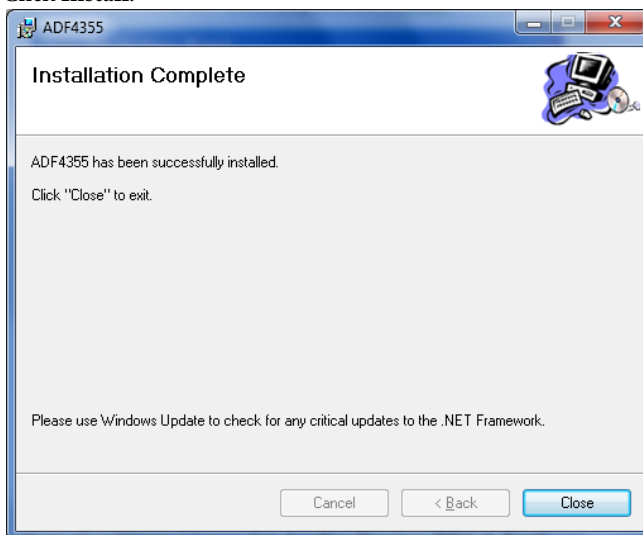

Figure 13. Windows Vista/7 ADF4355 Software Installation, Install Complete

5. Click **Close**.

### Windows XP Driver Installation Guide



Figure 14. Windows XP USB Driver Installation, Found New Hardware Wizard

1. Choose **Yes, this time only** and click **Next**.

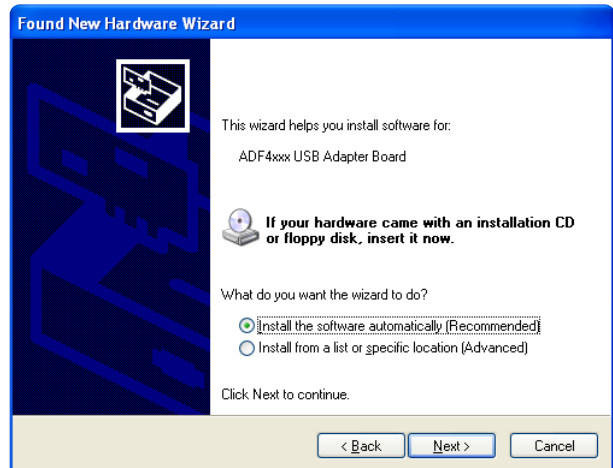

Figure 15. Windows XP USB Driver Installation, Install Options

2. Click **Next**.

Note that Figure 15 may list **Analog Devices RFG.L Eval Board** instead of **ADF4xxx USB Adapter Board**.



Figure 16. Windows XP USB Driver Installation, Logo Testing

3. Click **Continue Anyway**.

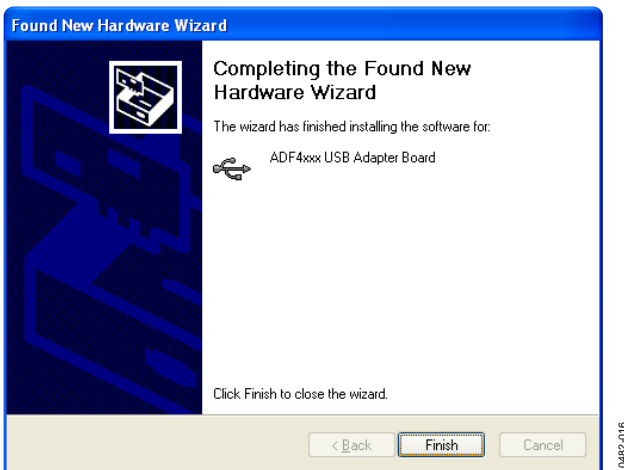

Figure 17. Windows XP USB Driver Installation, Complete Installation

4. Click **Finish**.



## EVALUATION BOARD SOFTWARE

The control software for the EV-ADF5355SD1Z is available on the CD included in the evaluation kit. To install the software, see the software installation section. **Ensure to install the software first.**

To run the software, first connect the SDP board to the USB port of the PC, and the SDP board to the evaluation board and then click the **ADF4355** file on the desktop or in the **Start** menu. Select SDP board and click connect. Note that, when connecting the board, it takes about 5 sec to 10 sec for the status label to change.

If the software is started before the board is connected to USB port, an error window opens, informing that the USB device was not found, and the **No USB** message is displayed in the top right corner of the software front panel window. In this case,

connect the SDP board to the USB port and click the **Connect** button.

- 1) Connect the SDP-S board to the EV-ADF5355 board.
- 2) Start the software.
- 3) Select SDP board as the connection method, select ADF5355 as the part.
- 4) Connect 6.0V to the EV-ADF5355SD1Z board, but ensure the switch s1 is in the off position.
- 5) Turn switch on (To the left).
- 6) Load configuration file (if applicable).
- 7) Write all registers.
- 8) A phase noise plot as below was taken with the register settings below.

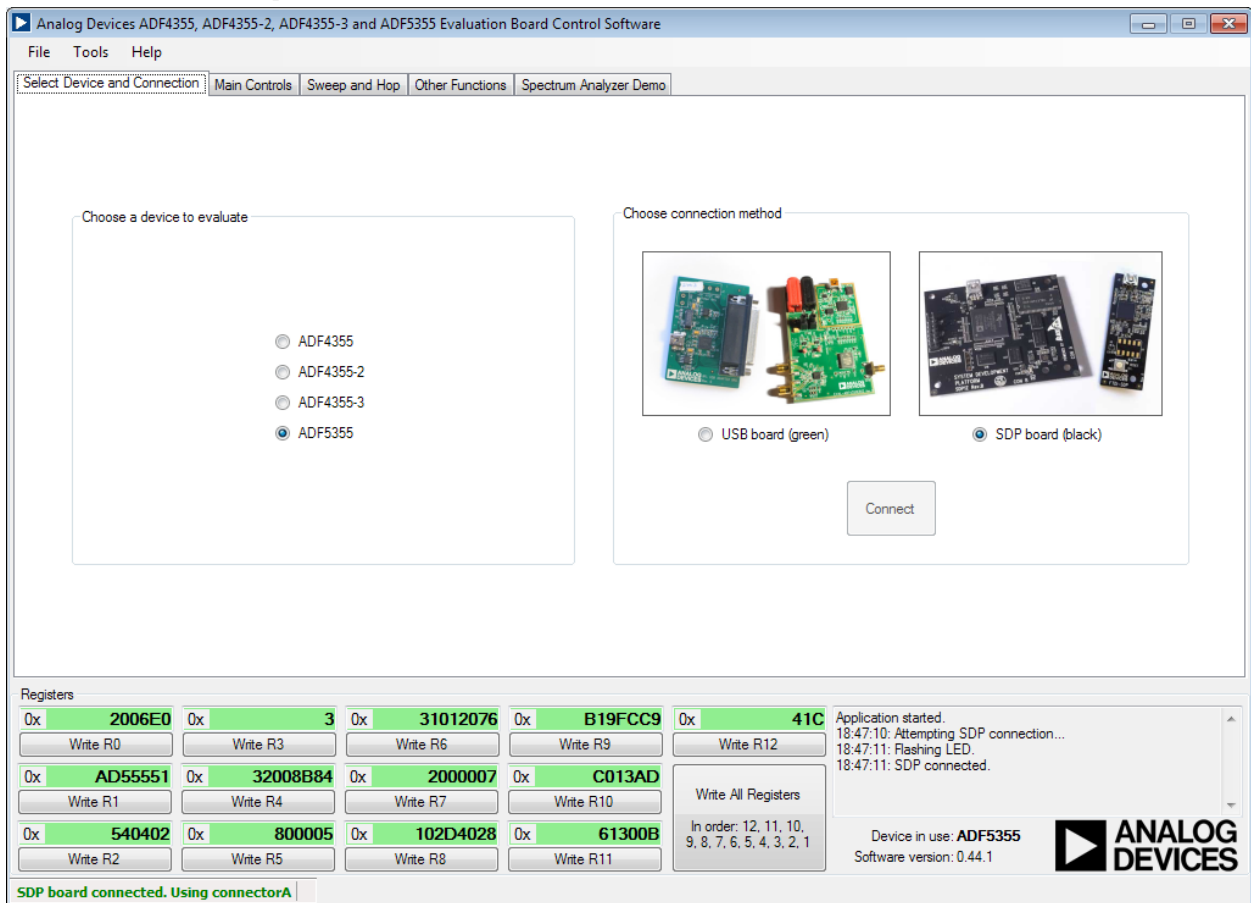

Figure 18. Software Front Panel Display—Select Device and Connection

To adjust the synthesizer parameters click the main controls tab.

Use the **Frequency** text box in the **Reference** section to set the correct reference frequency. The default reference on the software window is at 122.88 MHz which can be supplied externally. Please change to the actual REFIN frequency.

Use the **RF Frequency** section to control the output frequency. To achieve single-tone on the VCO output, type the desired output frequency text box in megahertz.

Default settings are recommended for most registers. Changing the settings on the software GUI requires the user to update the register with the register button, which is highlighted in green.

Bleed current settings may need to be modified for optimal operation.

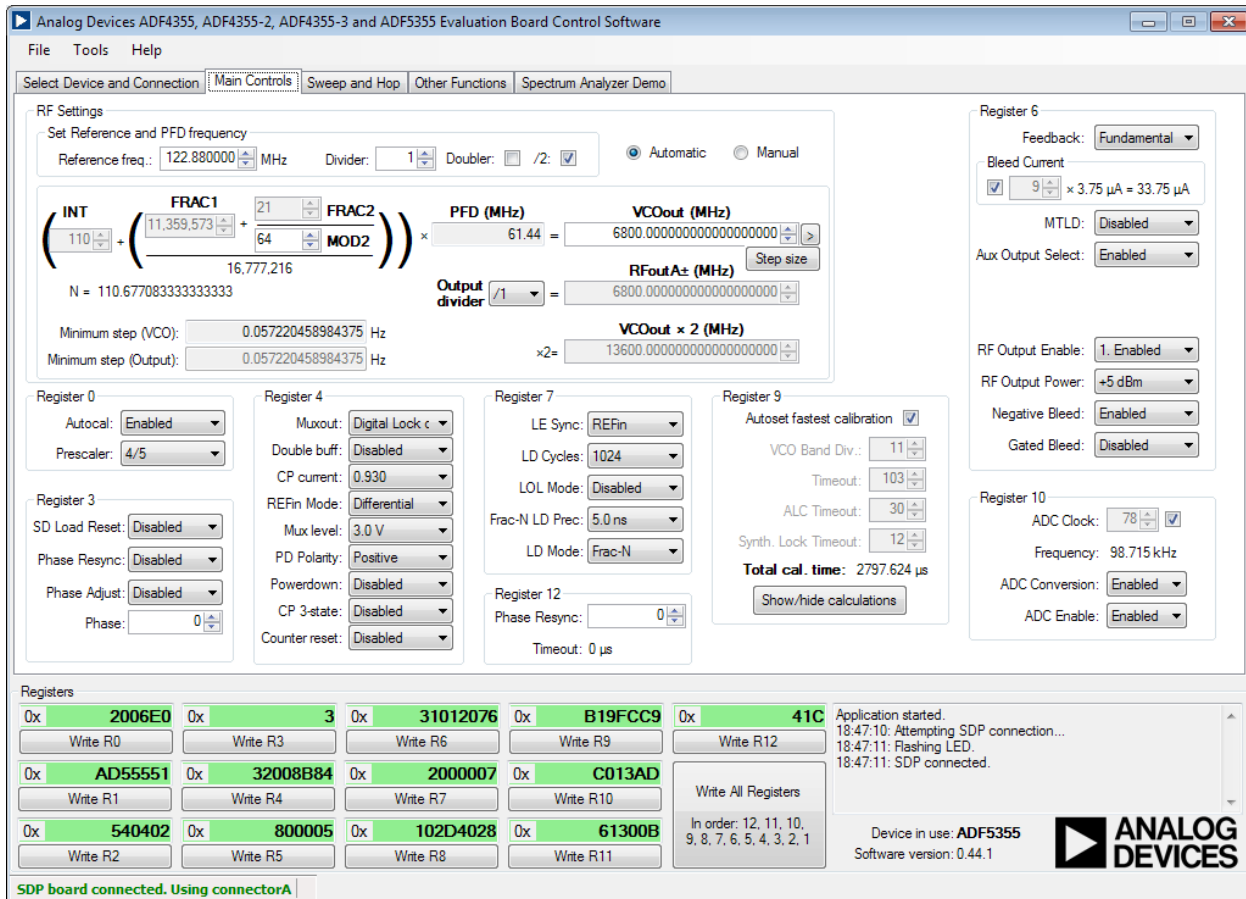
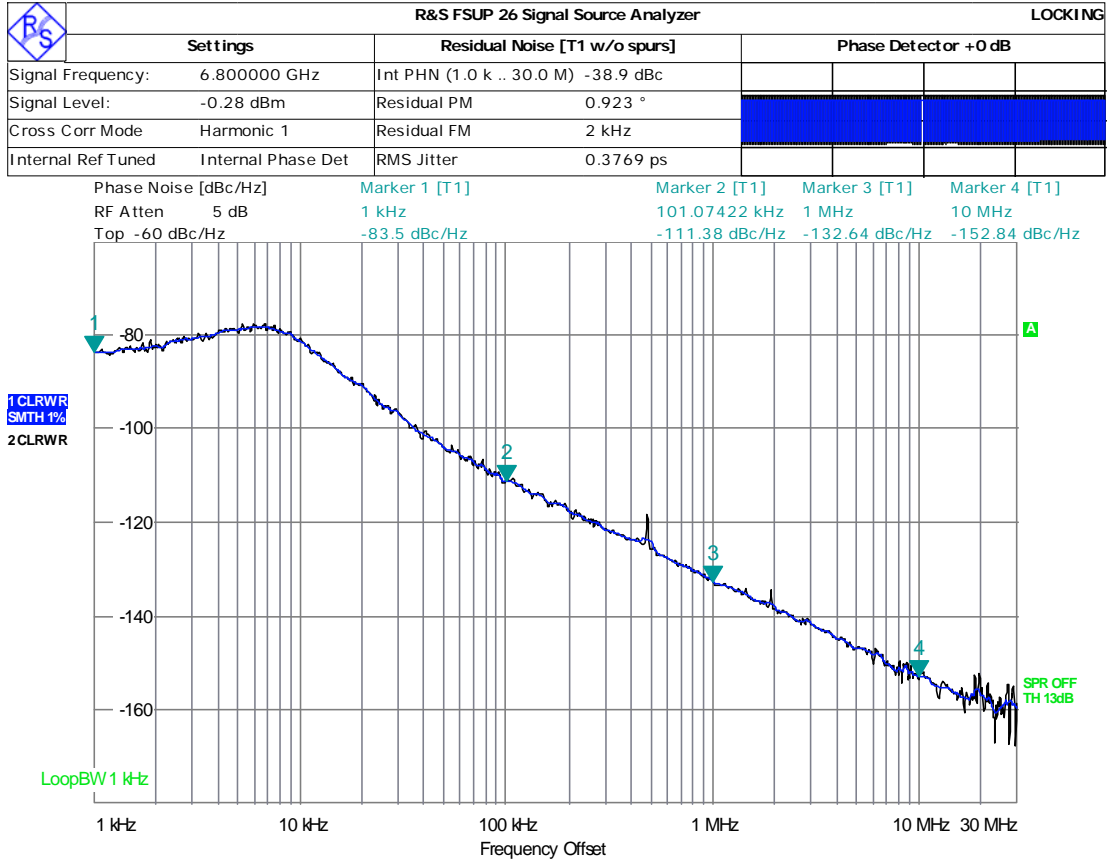

Figure 19. Register Settings



Running ...

Date: 17.OCT.2014 17:05:06

Figure20. Single Sideband Plot







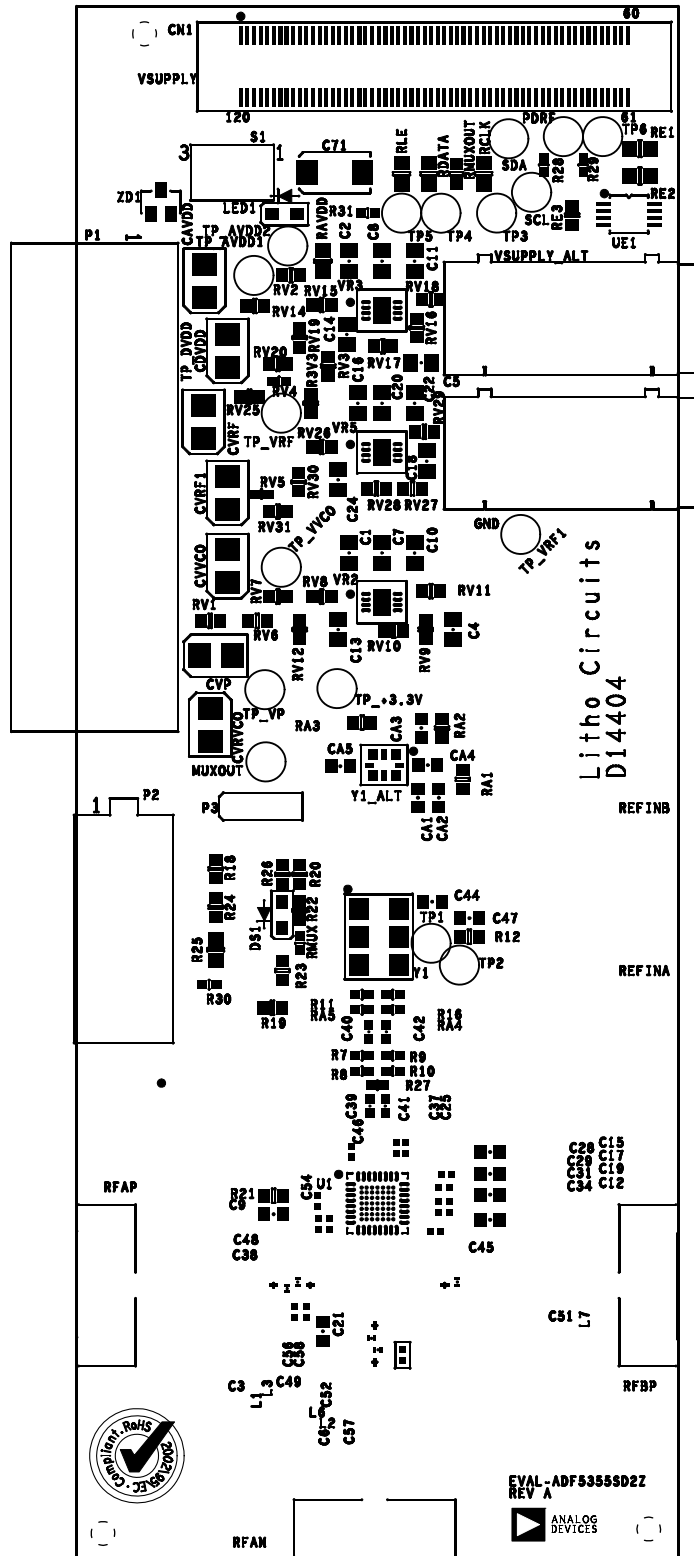

Figure 23. Evaluation Board Silk Screen(Top Side)

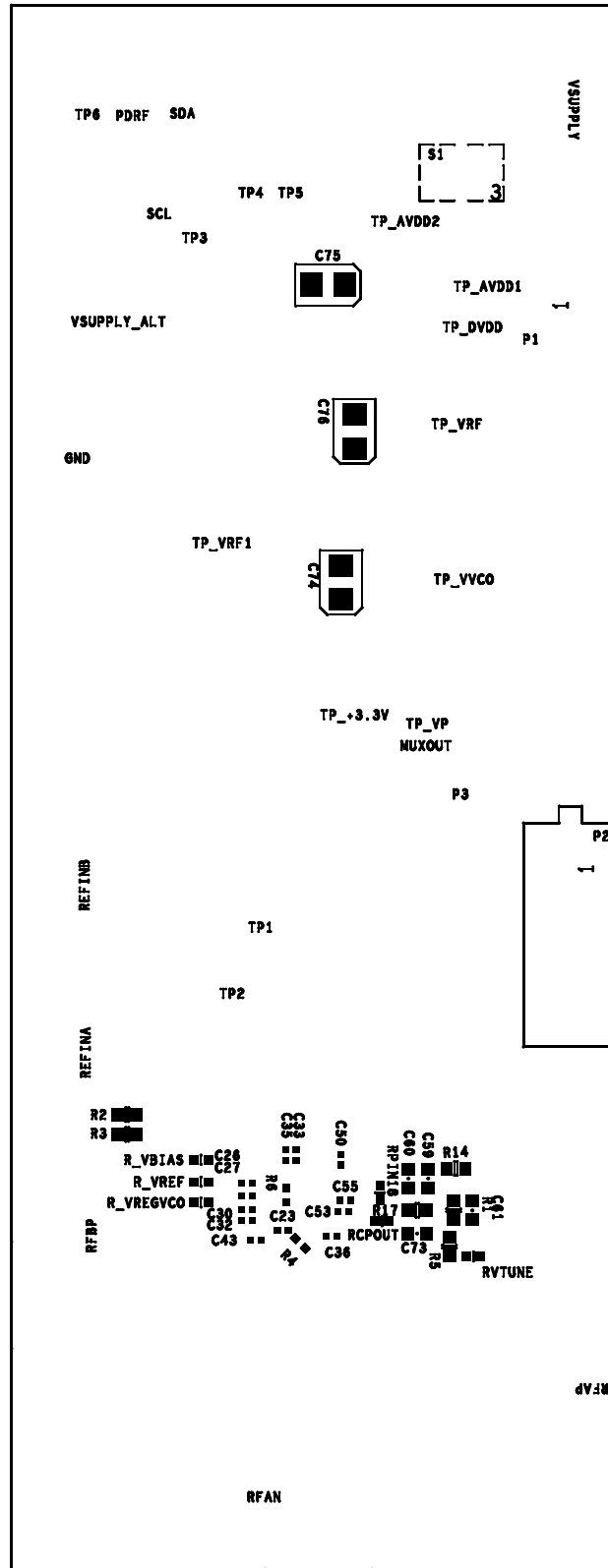

Figure 24 Evaluation Board Silk Screen, (Reverse side)



## NOTES

**ESD Caution**

**ESD (electrostatic discharge) sensitive device.** Charged devices and circuit boards can discharge without detection. Although this product features patented or proprietary protection circuitry, damage may occur on devices subjected to high energy ESD. Therefore, proper ESD precautions should be taken to avoid performance degradation or loss of functionality.

**Legal Terms and Conditions** By using the evaluation board discussed herein (together with any tools, components documentation or support materials, the "Evaluation Board"), you are agreeing to be bound by the terms and conditions set forth below ("Agreement") unless you have purchased the Evaluation Board, in which case the Analog Devices Standard Terms and Conditions of Sale shall govern. Do not use the Evaluation Board until you have read and agreed to the Agreement. Your use of the Evaluation Board shall signify your acceptance of the Agreement. This Agreement is made by and between you ("Customer") and Analog Devices, Inc. ("ADI"), with its principal place of business at One Technology Way, Norwood, MA 02062, USA. Subject to the terms and conditions of the Agreement, ADI hereby grants to Customer a free, limited, personal, temporary, non-exclusive, non-sublicensable, non-transferable license to use the Evaluation Board FOR EVALUATION PURPOSES ONLY. Customer understands and agrees that the Evaluation Board is provided for the sole and exclusive purpose referenced above, and agrees not to use the Evaluation Board for any other purpose. Furthermore, the license granted is expressly made subject to the following additional limitations: Customer shall not (i) rent, lease, display, sell, transfer, assign, sublicense, or distribute the Evaluation Board; and (ii) permit any Third Party to access the Evaluation Board. As used herein, the term "Third Party" includes any entity other than ADI, Customer, their employees, affiliates and in-house consultants. The Evaluation Board is NOT sold to Customer; all rights not expressly granted herein, including ownership of the Evaluation Board, are reserved by ADI. CONFIDENTIALITY. This Agreement and the Evaluation Board shall all be considered the confidential and proprietary information of ADI. Customer may not disclose or transfer any portion of the Evaluation Board to any other party for any reason. Upon discontinuation of use of the Evaluation Board or termination of this Agreement, Customer agrees to promptly return the Evaluation Board to ADI. ADDITIONAL RESTRICTIONS. Customer may not disassemble, decompile or reverse engineer chips on the Evaluation Board. Customer shall inform ADI of any occurred damages or any modifications or alterations it makes to the Evaluation Board, including but not limited to soldering or any other activity that affects the material content of the Evaluation Board. Modifications to the Evaluation Board must comply with applicable law, including but not limited to the RoHS Directive. TERMINATION. ADI may terminate this Agreement at any time upon giving written notice to Customer. Customer agrees to return to ADI the Evaluation Board at that time. LIMITATION OF LIABILITY. THE EVALUATION BOARD PROVIDED HEREUNDER IS PROVIDED "AS IS" AND ADI MAKES NO WARRANTIES OR REPRESENTATIONS OF ANY KIND WITH RESPECT TO IT. ADI SPECIFICALLY DISCLAIMS ANY REPRESENTATIONS, ENDORSEMENTS, GUARANTEES, OR WARRANTIES, EXPRESS OR IMPLIED, RELATED TO THE EVALUATION BOARD INCLUDING, BUT NOT LIMITED TO, THE IMPLIED WARRANTY OF MERCHANTABILITY, TITLE, FITNESS FOR A PARTICULAR PURPOSE OR NON-INFRINGEMENT OF INTELLECTUAL PROPERTY RIGHTS. IN NO EVENT WILL ADI AND ITS LICENSORS BE LIABLE FOR ANY INCIDENTAL, SPECIAL, INDIRECT, OR CONSEQUENTIAL DAMAGES RESULTING FROM CUSTOMER'S POSSESSION OR USE OF THE EVALUATION BOARD, INCLUDING BUT NOT LIMITED TO LOST PROFITS, DELAY COSTS, LABOR COSTS OR LOSS OF GOODWILL. ADI'S TOTAL LIABILITY FROM ANY AND ALL CAUSES SHALL BE LIMITED TO THE AMOUNT OF ONE HUNDRED US DOLLARS (\$100.00). EXPORT. Customer agrees that it will not directly or indirectly export the Evaluation Board to another country, and that it will comply with all applicable United States federal laws and regulations relating to exports. GOVERNING LAW. This Agreement shall be governed by and construed in accordance with the substantive laws of the Commonwealth of Massachusetts (excluding conflict of law rules). Any legal action regarding this Agreement will be heard in the state or federal courts having jurisdiction in Suffolk County, Massachusetts, and Customer hereby submits to the personal jurisdiction and venue of such courts. The United Nations Convention on Contracts for the International Sale of Goods shall not apply to this Agreement and is expressly disclaimed.