

Features

- Fast switching device ($T_{rr} < 4.0ns$)
- Surface device type mounting
- Moisture sensitivity level 1
- Matte Tin(Sn) lead finish with Nickel(Ni) underplate
- Pb free version and RoHS compliant
- Green compound (Halogen free) with suffix "G" on packing code and prefix "G" on date code



Mechanical Data

- Case : Flat lead SOT-323 small outline plastic package
- Terminal : Matte tin plated, solderable per MIL-STD-202, Method 208 guaranteed
- High temperature soldering guaranteed: 260°C/S
- Polarity : Indicated by cathode band
- Weight : 5 mg

Pin Configuration

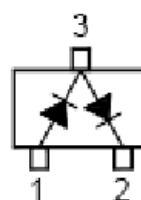

Maximum Ratings and Electrical Characteristics

Rating at 25 °C ambient temperature unless otherwise specified.

Absolute Maximum Ratings ($T_A = 25^\circ C$)

Parameter	Symbol	Value	Units
Peak Repetitive Reverse Voltage	V_{RRM}	85	V
Reverse Voltage	V_R	75	V
Continuous Forward Current	Single Diode Load	150	mA
	Double Diode Load	130	
Repetitive Peak Forward Current	I_{FRM}	500	mA
Peak Forward Surge Current ($t_p = 10ms$)	at $t = 1\mu s$	4	A
	at $t = 1ms$	1	
	at $t = 1s$	0.5	
Total Power Dissipation	P_{tot}	200	mW
Thermal Resistance form Junction Ambient	R_{thJA}	625	$^\circ C/W$
Junction Temperature	T_J	150	$^\circ C$
Storage Temperature Range	T_{STG}	- 55 to + 150	$^\circ C$

Characteristics at $T_A = 25^\circ C$

Parameter	Symbol	Max.	Units
Forward Voltage at $I_F = 1 mA$ at $I_F = 10 mA$ at $I_F = 50 mA$ at $I_F = 150 mA$	V_F	0.715	V
		0.855	
		1	
		1.25	
Reverse Current at $V_R = 25 V$ at $V_R = 75 V$ at $V_R = 25 V, T_j = 150^\circ C$ at $V_R = 75 V, T_j = 150^\circ C$	I_R	30	nA
		1	uA
		30	uA
		50	uA
Total Capacitance at $V_R = 0 V, f = 1 MHz$	C_d	1.5	pF
Reverse Recovery Time at $I_F = I_R = 10 mA, I_{rr} = 0.1 \times I_R, R_L = 100 \Omega$	t_{rr}	4	ns

Small Signal Product

Fig. 1 Forward Current Derating Curve

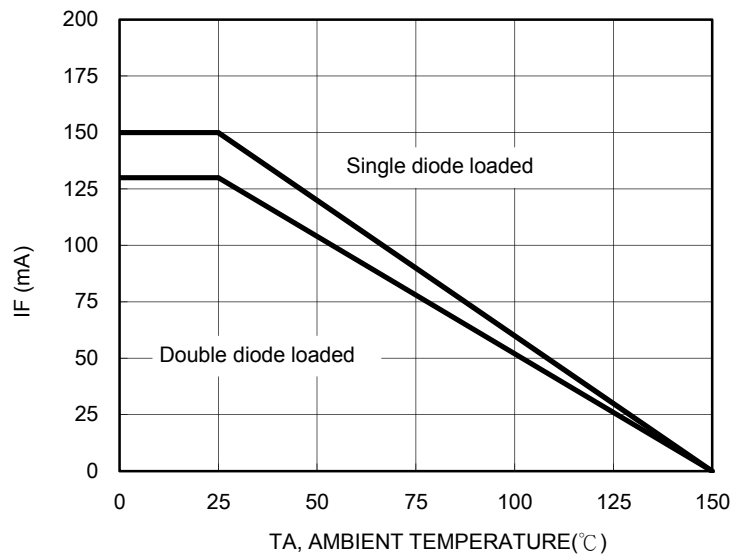

Fig. 2 Forward Characteristics

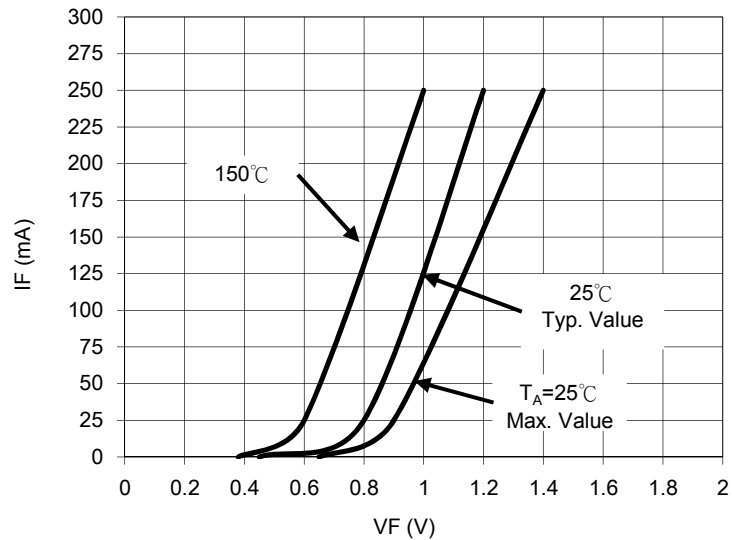

Fig. 3 Maximim Non-repetitive Peak Forward Surge Current

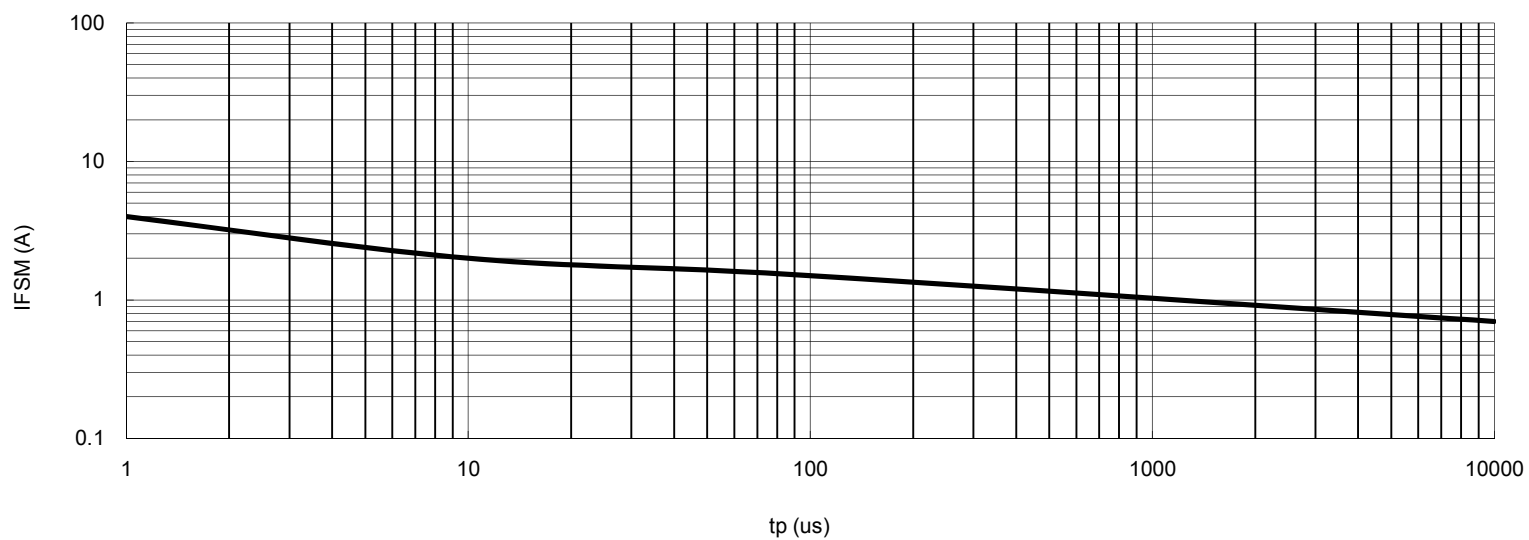

Fig. 4 Typical Reverse Characteristics

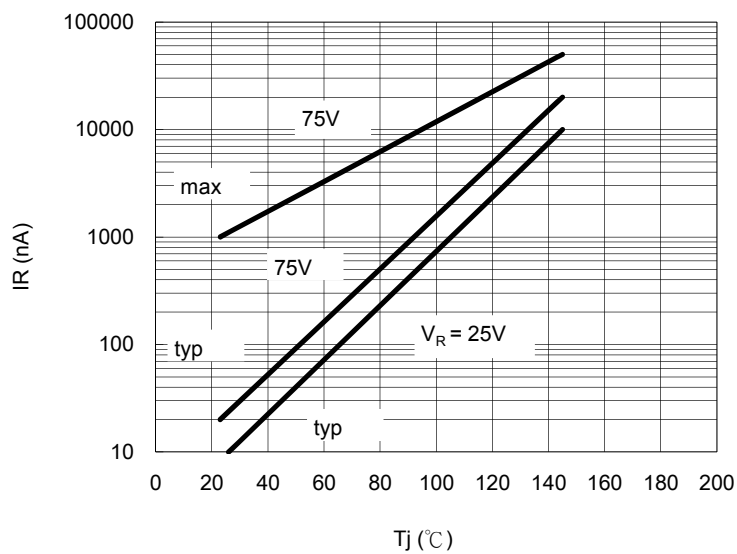
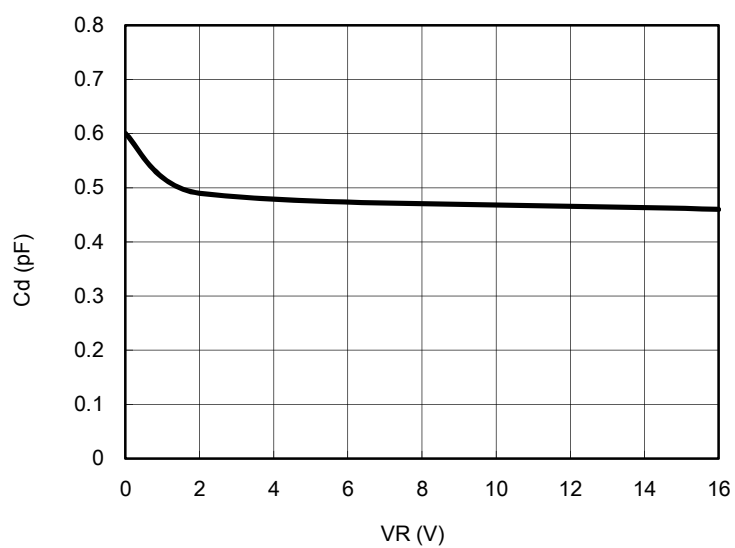
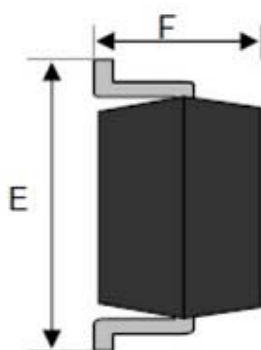
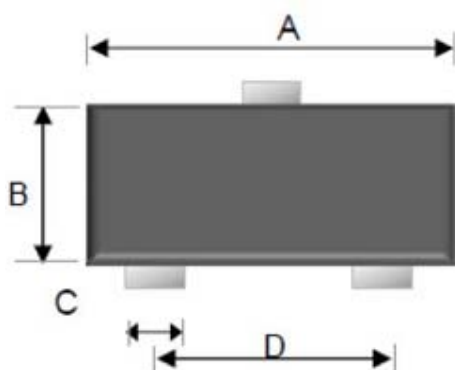

Fig. 5 Typical Capacitance



Small Signal Product

Dimensions



DIM.	Unit(mm)		Unit(inch)	
	Min	Max	Min	Max
A	1.90	2.10	0.075	0.083
B	1.15	1.35	0.045	0.053
C	0.25	0.35	0.010	0.014
D	1.20	1.40	0.047	0.055
E	2.00	2.45	0.079	0.096
F	0.80	1.00	0.031	0.039

Ordering Information

Part No.	Package	Packing	Packing code	Packing code (Green)	Marking
BAV99W	SOT-323	3K / 7" Reel	RF	RFG	A7

Tape and Reel specification

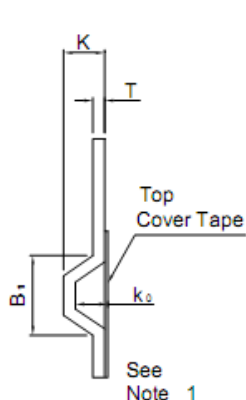

For Machine Reference Only
Including Draft And RADLL
Concentric Around Bo

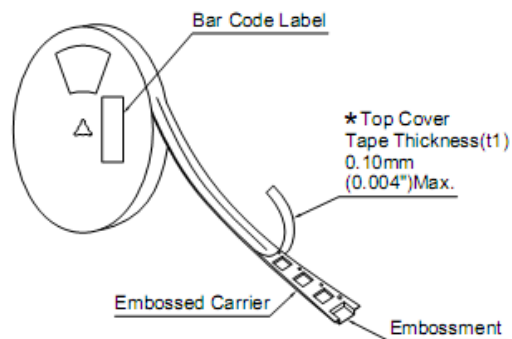
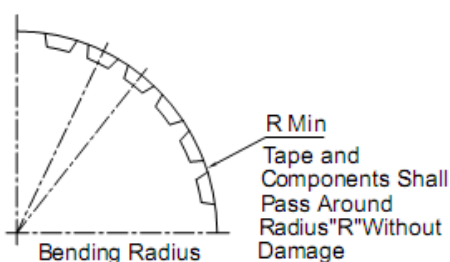
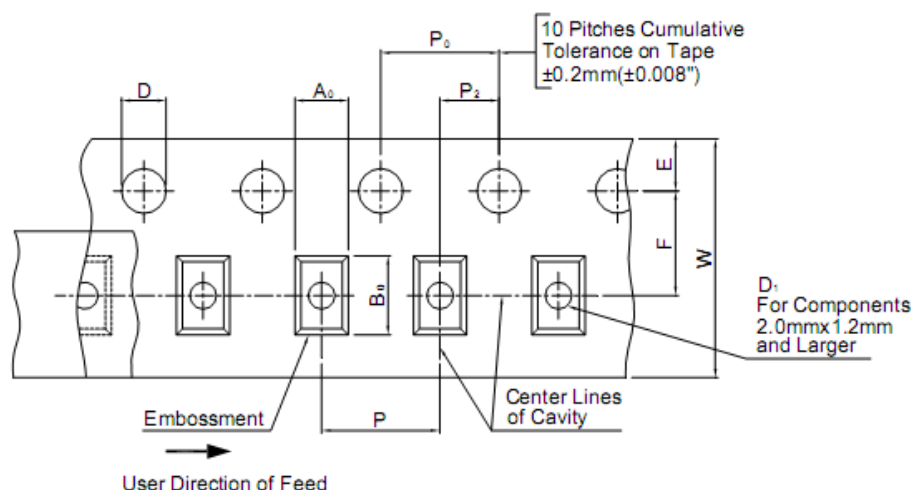

Tape Size	B1	D	D1	E	F	K	P0	P2	R
	max	+0.1;-0	min	±1.0	±0.05	max	±0.1	±0.1	min
8 mm	4.55	1.5	1	1.75	3.5	2.4	4	2	25

T	W
max	max
0.6	8.3

Unit (mm)