

DATA SHEET

CITILED COB Series
Standard Type

CLU026-1203C1

CITILED[®]
The Light Engine

CONTENTS

1. Introduction	P 2
2. Performance Characteristics	P 3
3. Mechanical Dimensions	P 5
4. Characteristic Curves	P 6
5. Reliability	P 9
6. Packing Specification	P 10
7. Precaution	P 11

CITIZEN ELECTRONICS CO., LTD.

1-23-1, Kamikurechi, Fujiyoshida-shi, Yamanashi, 403-0001, Japan Tel. +81-555-23-4121 <http://ce.citizen.co.jp>
Copyright © 2010 CITIZEN ELECTRONICS CO., LTD. All Rights reserved.

Product Nomenclature

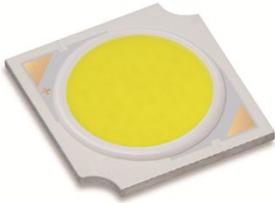

CLU026 - 12 03 C1 - 27 3 M2 G2
[1] [2] [3] [4] [5]

[1]	Product shape	CLU026
[2]	Die count in series	12
[3]	Die count in parallel	03
[4]	Nominal CCT	2700K
[5]	CRI (Ra)	Min.80

1. Introduction

1-1. Product Description

CITIZEN ELECTRONICS is the first COB manufacture. Our advanced knowledge and packaging technology for many years has excellent reliability and high quality of our products. CITILED COB Series covers a wide range of luminous flux from a 10W incandescent bulb to a 300W mercury lamp in general lighting sources. The element arrangement of LED package is capable of utilizing light more effectively and higher performance.

The new version of CITILED COB series increase the performance significantly from previous version. New version creates more options to match luminaire's products design (ex. High performance, Cost effective, Small Light Emitting Surface(LES), Increased allowable max. If). Emitted light density of the LED package is improved higher for suitable use of light-condensing products. The outline and LES size is the same as for previous version. Thus existing parts of 3rd parties are compatible in mechanical characteristics. All of specs are at hot binning (Tj=85°C).

1-2. Features

- Mechanical Dimensions : 13.5×13.5×1.4 (mm)
- Package Structure : Aluminum Base Chip on Board
- Reference Assembly : M3 screw, Connector
- CRI (Ra) : 80Min., 70Min.
- Nominal CCT : 2,700K, 3,000K, 3,500K, 4,000K, 5,000K, 6,500K (CRI(Ra) 80Min.)
3,000K, 4,000K, 5,000K (CRI(Ra) 70Min.)
- Chromaticity Range : 3-step MacAdam Ellipse, the center refers to ANSI C78.377:2011. (CRI(Ra) 80Min.)
ANSI C78.377:2011. compliant (CRI(Ra) 70Min.)
- Thermal Resistance : 1.7C/W
- Maximum drive current : 690mA
- RoHS compliant
- Better die arrangement for optics
- Wide range of luminous flux and high efficacy
- Improved lumen density compared with previous version

2. Performance Characteristics

2-1. Electro Optical Characteristics

(Tj=85C)

Product code	Nominal CCT	CRI		Luminous flux (lm)			Efficacy (lm/W)	Forward Current (mA)	Voltage (V)			Thermal Resistance Rj-c (C/W)
		Ra	R9	Tj=85C		Tc=25C*			Min.	Typ.	Max.	
		Min.	Min.	Min.	Typ.	Typ.	Typ.					
CLU026-1203C1-273M2G2	2700K	80	0	1,074	1,221	1,330	131	270	31.8	34.6	37.5	1.7
CLU026-1203C1-303M2G2	3000K	80	0	1,124	1,278	1,392	137	270	31.8	34.6	37.5	1.7
CLU026-1203C1-353M2G2	3500K	80	0	1,147	1,304	1,420	139	270	31.8	34.6	37.5	1.7
CLU026-1203C1-403M2G2	4000K	80	0	1,161	1,320	1,438	141	270	31.8	34.6	37.5	1.7
CLU026-1203C1-503M2G2	5000K	80	0	1,179	1,340	1,460	143	270	31.8	34.6	37.5	1.7
CLU026-1203C1-653M2G2	6500K	80	0	1,202	1,367	1,489	146	270	31.8	34.6	37.5	1.7
CLU026-1203C1-30AL7G4	3000K	70	-	1,214	1,380	1,503	148	270	31.8	34.6	37.5	1.7
CLU026-1203C1-40AL7G4	4000K	70	-	1,254	1,426	1,553	152	270	31.8	34.6	37.5	1.7
CLU026-1203C1-50AL7G4	5000K	70	-	1,273	1,447	1,576	155	270	31.8	34.6	37.5	1.7

Notes :

1. Citizen Electronics maintains forward voltage +/-3%, luminous flux +/-10%, Ra and R9 +/-1.

*Values of Luminous flux at Tc=25C are provided as reference only.

2-2. Absolute Maximum Ratings

Absolute Maximum Ratings

Parameter	Symbol	Rating	
Input Power (W)	Pi	29.4	*1
Forward Current (mA)	If	690	*1
Minimum Current (mA)	If min	15	
Reverse Current (mA)	Ir	1	
Operating Temperature (C)	Top	-40 ~ +100	
Storage Temperature (C)	Tst	-40 ~ +100	
Case Temperature (C)	Tc	105	*2
Junction Temperature (C)	Tj	140	*3

*1. Input power and forward current are the values when the LED is used within the range of the derating curve in this data sheet.

*2. Refer to 3. Outline drawing for Tc measurement point.

*3. D.C. Current : $T_j = T_c + R_{j-c} \times P_i$

Copyright © 2010 CITIZEN ELECTRONICS CO., LTD. All Rights reserved.

CITIZEN ELECTRONICS CO., LTD.

1-23-1, Kamikurechi, Fujiyoshida-shi, Yamanashi, 403-0001, Japan
Tel. +81-555-23-4121 <http://ce.citizen.co.jp>

2-3. Chromaticity Characteristics

(Rated current, Tj=85C)

Color Region	Nominal CCT	Center Point (x, y)	Oval parameter		
			Major Axis a	Minor Axis b	Ellipse Rotation Angle θ
3-step MacAdam ellipse	2700K	(0.4577 , 0.4098)	0.00774	0.00411	57.28
	3000K	(0.4339 , 0.4032)	0.00834	0.00408	53.17
	3500K	(0.4078 , 0.3929)	0.00951	0.00417	52.97
	4000K	(0.3818 , 0.3796)	0.00939	0.00402	54.00
	5000K	(0.3446 , 0.3551)	0.00822	0.00354	59.62
	6500K	(0.3123 , 0.3283)	0.00669	0.00285	58.38

Color Region	Nominal CCT	Center Point (x, y)	ANSI parameter							
			a (x, y)		b (x, y)		c (x, y)		d (x, y)	
ANSI C78. 377:2011	3000K	(0.4339 , 0.4032)	0.4561	0.4259	0.4302	0.4171	0.4149	0.3820	0.4373	0.3892
	4000K	(0.3818 , 0.3796)	0.4003	0.4034	0.3737	0.3879	0.3671	0.3583	0.3895	0.3708
	5000K	(0.3446 , 0.3551)	0.3550	0.3752	0.3375	0.3619	0.3366	0.3372	0.3514	0.3480

* Color region stay within MacAdam 3-step ellipse from the chromaticity center.

* The chromaticity center refers to ANSI C78.377:2011.

Please refer to ANSI C78. 377 for the chromaticity center.

* θ is the angle between the major axis of the ellipse and the x-axis, and a and b are the major and minor semi-axes of an ellipse.

(Ref. IEC 60081:1997 AnnexD)

x-y chart CIE1931

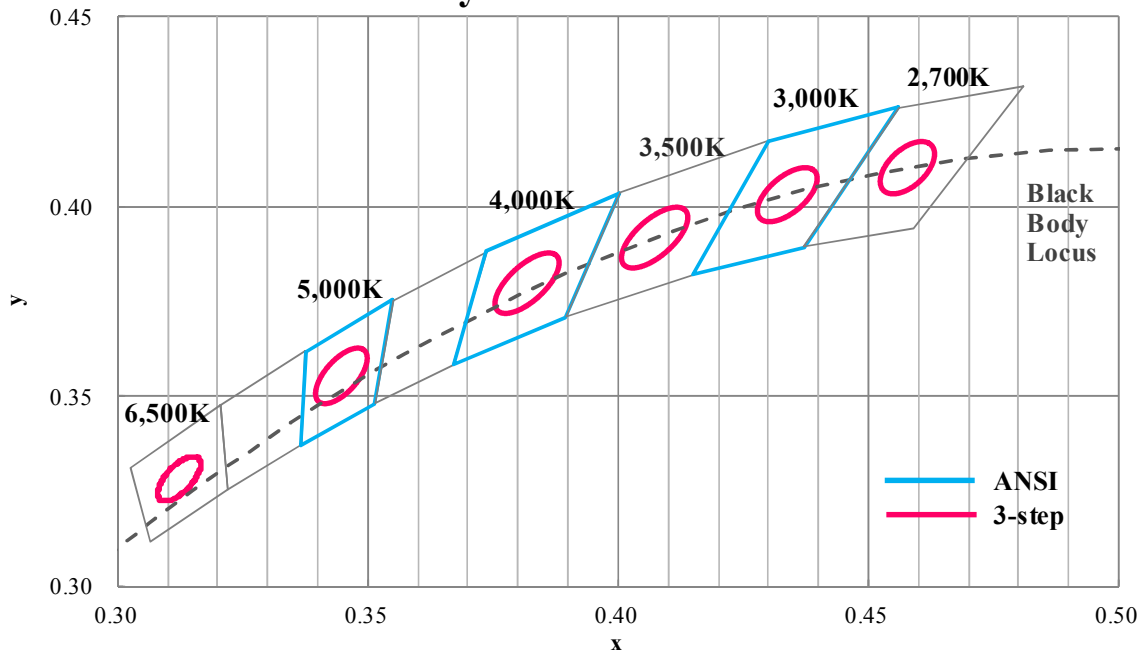

Note : Citizen Electronics maintains chromaticity (x, y) +/-0.005

Copyright © 2010 CITIZEN ELECTRONICS CO., LTD. All Rights reserved.

3. Mechanical Dimensions

Unit : mm

Tolerances unless otherwise specified : +/-0.3

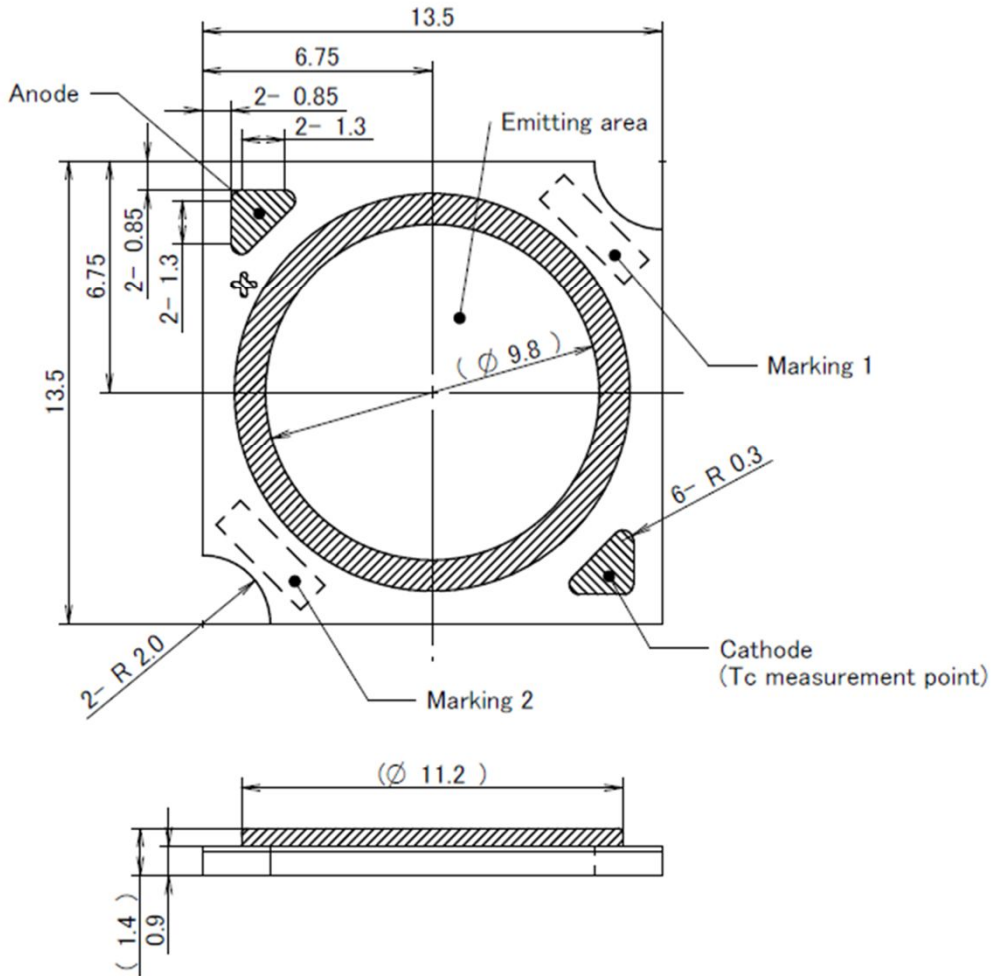

Marking 1 : Serial No.

Marking 2 : C 12 03 ** **



4. Characteristic Curves

4-1. Forward Current Characteristics / Temperature Characteristics

Forward Current vs. Forward Voltage

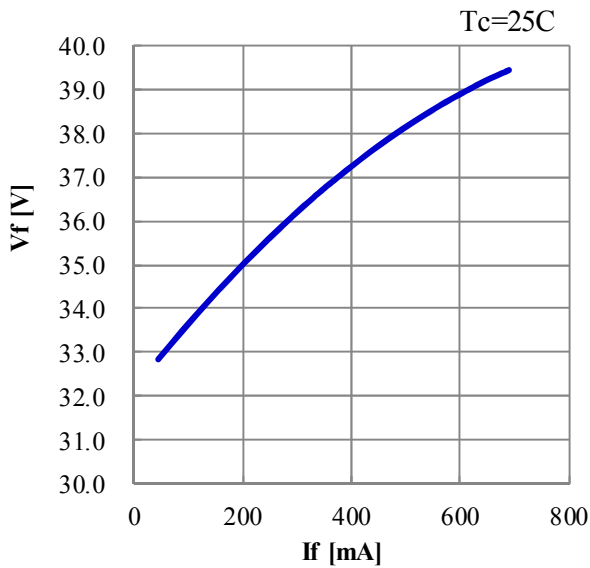

Forward Current vs. Relative Luminous Flux

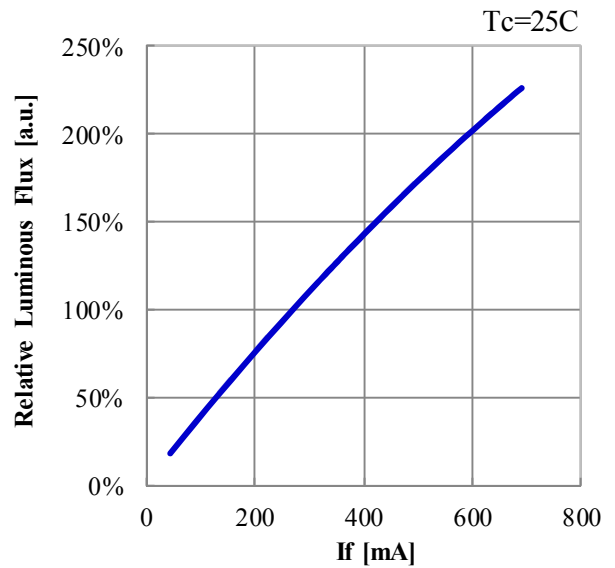

Case Temperature vs. Forward Voltage

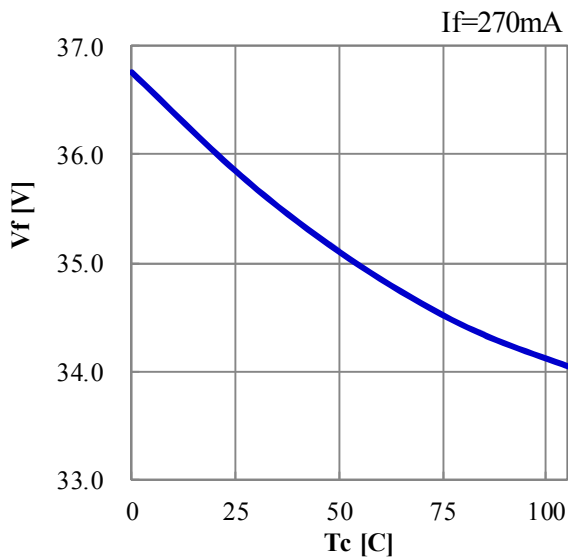

Case Temperature vs. Relative Luminous Flux

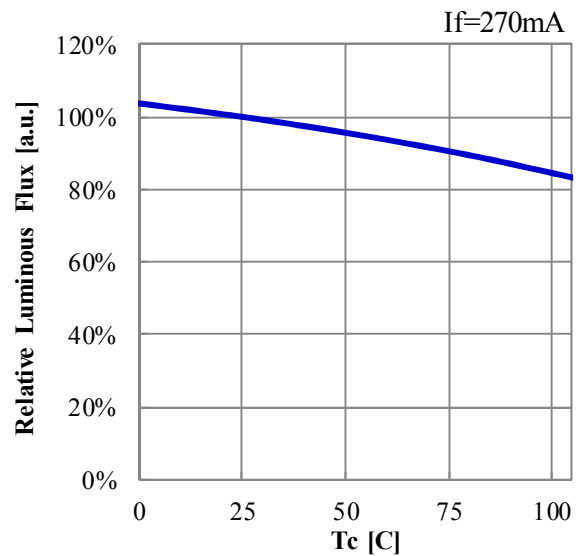

Copyright © 2010 CITIZEN ELECTRONICS CO., LTD. All Rights reserved.

4-2. Optical Characteristics

Spectrum : CRI(Ra) 80Min.

$T_j=85^{\circ}\text{C}$ $I_f=270\text{mA}$

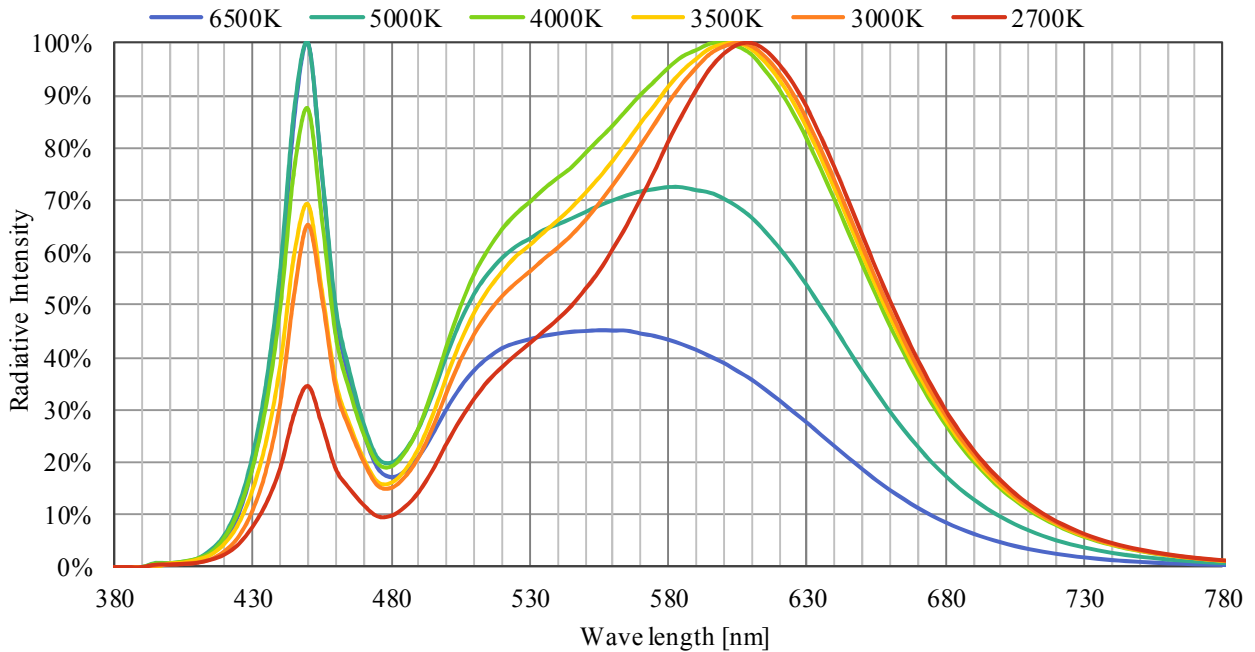

Spectrum : CRI(Ra) 70Min.

$T_j=85^{\circ}\text{C}$ $I_f=270\text{mA}$

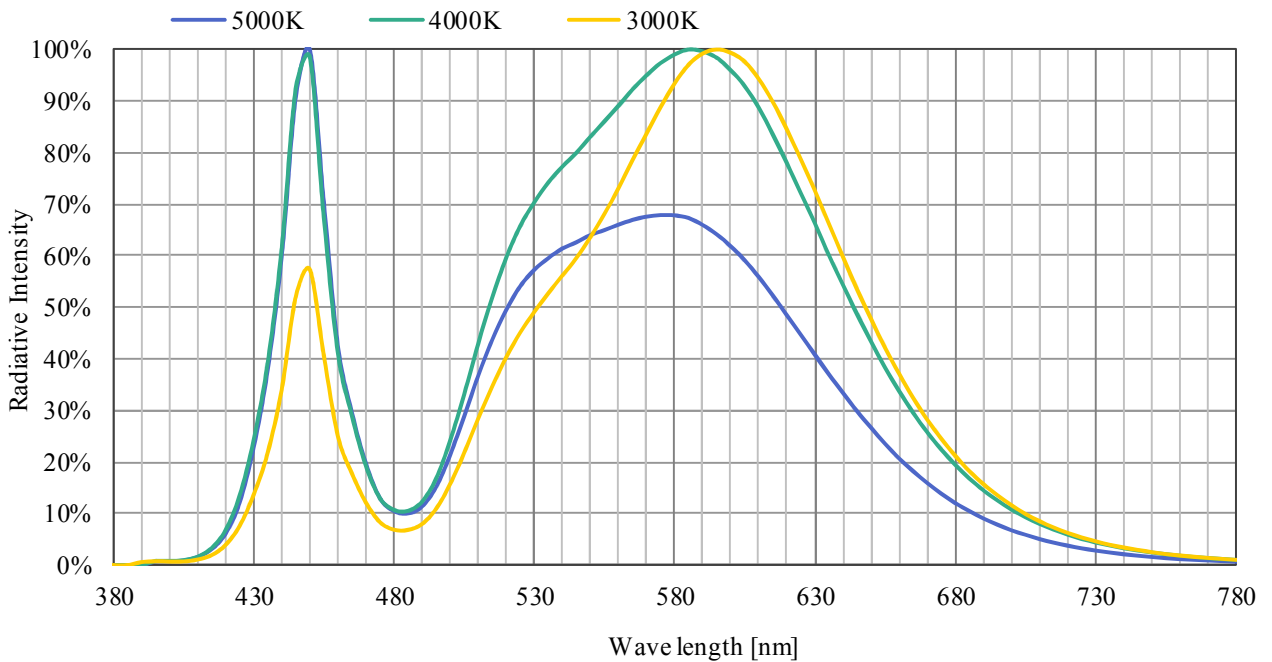

Copyright © 2010 CITIZEN ELECTRONICS CO., LTD. All Rights reserved.

4-2. Optical Characteristics (continued)

Radiation Characteristic

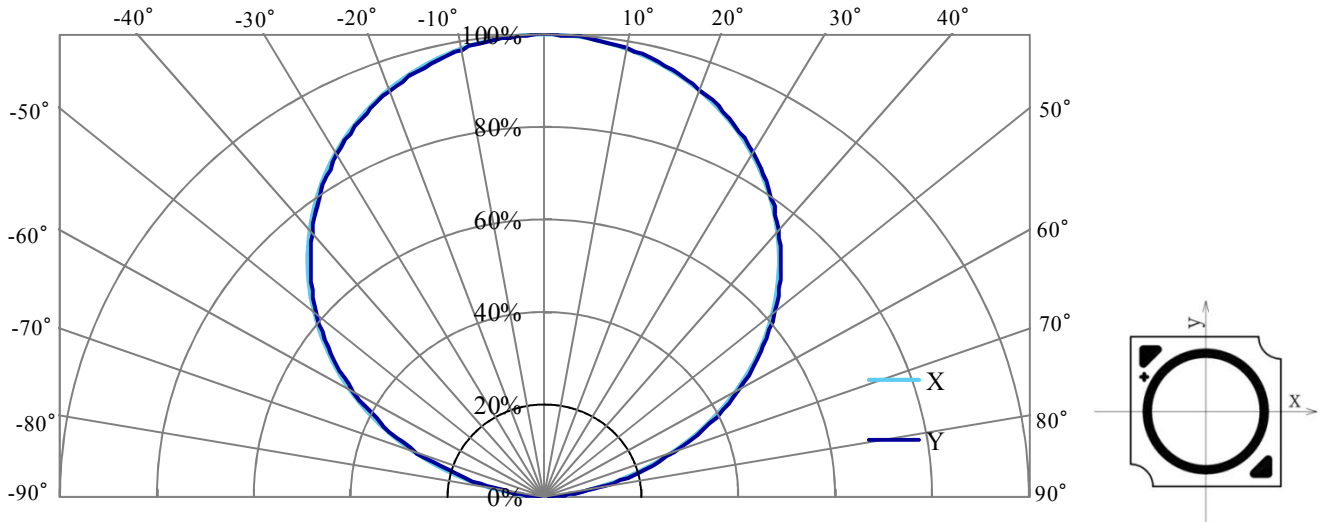

4-3. Derating Characteristics

Case Temperature

vs. Allowable Forward Current

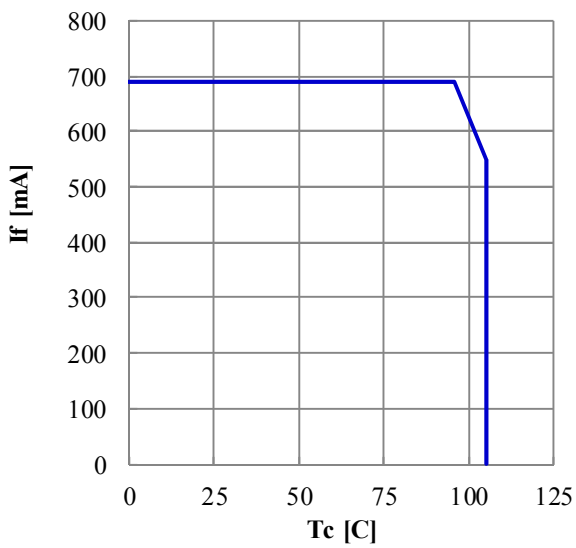

5. Reliability

5-1. Reliability Test

Test Item	Test Condition
Continuous Operation Test	IF=270mA Ta=25C (with Al-fin) ×1000hrs
	IF=270mA Tj=140C (with Al-fin) ×1000hrs
Low Temperature Storage Test	-40 C × 1000 hours
High Temperature Storage Test	100 C × 1000 hours
Moisture-proof Test	85 C, 85 %RH for 500 hours
Thermal Shock Test	-40 C × 30 minutes – 100 C × 30 minutes, 100 cycle

5-2. Failure Criteria

(Tc=25C)

Measuring Item	Symbol	Measuring Condition	Failure Criteria
Forward Voltage	Vf	If=270mA	>U × 1.1
Total Luminous Flux	Φv	If=270mA	<S × 0.85

U defines the upper limit of the specified characteristics. S defines the initial value.

Note : Measurement shall be taken between 2 hours and 24 hours, and the test pieces should be return to the normal ambient conditions after the completion of each test.

6. Packing Specification

6-1. Packing

An empty tray is placed on top of a 6-tier tray which contain 54 pieces each.
(Smallest packing unit: 324 pieces)

A label with product name, quantity and lot number is placed on the upper empty tray.

Tray (Dimensions: 310 x 210 x 12 mm / Materials: Electrically conductive PS)

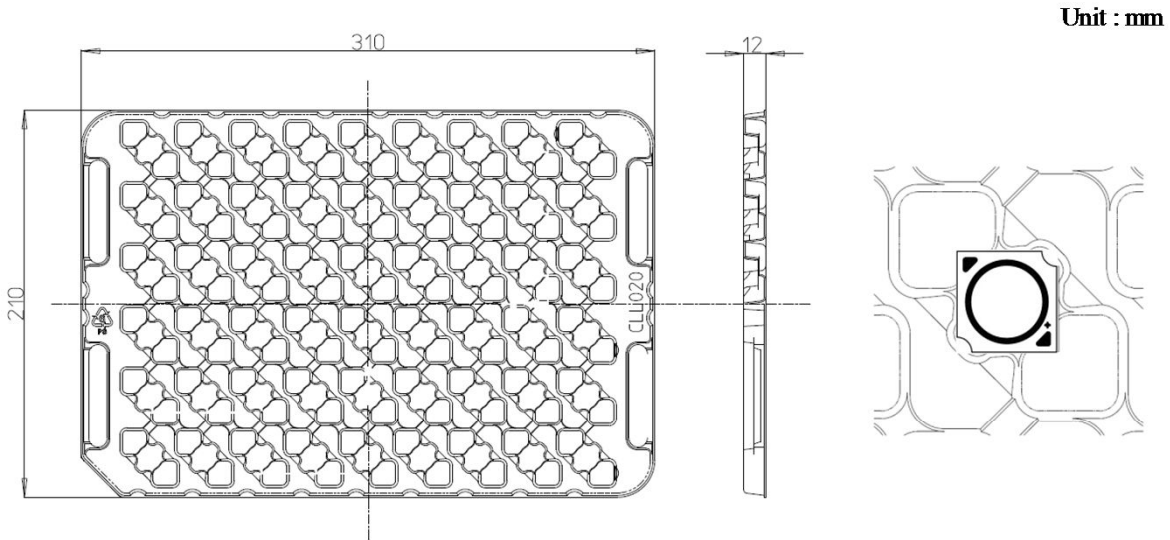

Product 54pcs/tray

Example of indication label

CUSTOMER	
TYPE	: CLU***_*****_***** --- (1)
P.NO	: ***** --- (2)
Lot No	: ***** --- (3)
Q'ty	: *** --- (4)
 CITIZEN ELECTRONICS CO., LTD.	

1. TYPE e.g. CLU026-1203C1

2. P.No. (Customer's P/N)

3. Lot No.

e.g. $\frac{1}{(1)} \frac{5}{(2)} \frac{5}{(3)} \frac{5}{(3)} \frac{0}{(3)} \frac{0}{(3)} \frac{1}{(3)}$

(1) Last two digit of the year 15 : year 2015

(2) Production month 5 : May

Note: October, November and December are designated X, Y and Z.

(3) CE's control number

4. Quantity

7. Precaution

7-1. Handling with care for this product

- Both the light emitting area and white rim around the light emitting area is composed of resin materials. Please avoid the resin area from being pressed, stressed, rubbed, come into contact with sharp metal nail (e.g. edge of reflector part) because the function, performance and reliability of this product are negatively impacted.
- Please be aware that this product should not come into contact with any other parts while incorporating in your lighting apparatus or your other products.
- Please be aware that careful handling is required after the attachment of lead wires to prevent the application of any load to the connections.
- For more information, please refer to application note "Instruction Manual(COB LED Package)".

7-2. Countermeasure against static electricity

- Handling of this product needs countermeasures against static electricity because this is a semiconductor product.
- Please take adequate measures to prevent any static electricity being produced such as the wearing of a wristband or anti-static gloves when handling this product.
- Every manufacturing facility in regard to the product (plant, equipment, machine, carrier machine and conveyance unit) should be connected to ground and please avoid the product to be electric-charged.
- ESD sensitivity of this product is over 1000V (HBM, based on JEITA ED-4701/304).
- After assembling the LEDs into your final product(s), it is recommended to check whether the assembled LEDs are damaged by static electricity (electrical leak phenomenon) or not.
- It is easy to find static damaged LED dies by a light-on test with the minimum current value.

7-3. Caution of product assembly

- Regarding this product assembling on the heat sink, it is recommended to use M3 screw. It might be good for screw tightening on the heat sink to do temporary tightening and final tightening. In addition, please don't press with excess stress on the product.
- The condition of the product assembling on the heat sink and the control of screw tightening torque needs to be optimized according to the specification of the heat sink.
- Roughness, unevenness and burr of surface negatively impact thermal bonding between the product and heat sink and increase heat thermal resistance between them. Confidence of thermally and mechanical coupling between the product and heat sink are confirmed by checking the mounting surface and measuring the case temperature of the product.
- In order to reduce the thermal resistance at assembly, it might be good to use TIM (Thermal Interface Material) on whole contact surface of the product. In case of using thermal grease for the TIM, it might be good to apply uniformly on the contact surface of the product. In case of using thermal sheet for the TIM, it might be good to make sure that the product is NOT strained by stress when the screws are tightened for assembly.
- For more information, please refer to application note "Instruction Manual(COB LED Package)".

7-4. Thermal Design

- The thermal design to draw heat away from the LED junction is most critical parameter for an LED illumination system. High operating temperatures at the LED junction adversely affect the performance of LED's light output and lifetime. Therefore the LED junction temperature should not exceed the absolute maximum rating in LED illumination system.
- The LED junction temperature while operation of LED illumination system depends upon thermal resistance of internal LED package (R_{j-c}), outer thermal resistances of LED package, power loss and ambient temperature. Please take both of the thermal design specifications and ambient temperature conditions into consideration for the setting of driving conditions.
- For more information, please refer to application note "Thermal Management", "Instruction Manual(COB LED Package)".

7-5. Driving Current

- A constant current is recommended as an applying driving current to this product. In the case of constant voltage driving, please connect current-limiting resistor to each products in series and control the driving current to keep under the absolute maximum rating forward current value.
- Electrical transient might apply excess voltage, excess current and reverse voltage to the product(s). They also affect negative impact on the product(s) therefore please make sure that no excess voltage, no excess current and no reverse voltage is applied to the product(s) when the LED driver is turn-on and/or turn-off.
- For more information, please refer to application note "Driving", "Instruction Manual(COB LED Package)".

7-6. Lighting at a minimum current value

- In a case where the minimum current(I_{F min}) is applied to the product, some of LED dice in the product might look different in their brightness due to the individual difference of the LED dice, and they are not failed.

7-7. Electrical Safety

- This product is designed and produced according to IEC 62031:2008 (IEC 62031:2008 LED modules for general lighting. Safety specification)
- Dielectric voltage withstand test has been conducted on this product to see any failure after applying voltage between active pads and aluminum section of the product, and to pass at least 500V.
- Considering conformity assessment for IEC62031:2008, almost all items of the specification depend upon your final product of LED illumination system. Therefore, please confirm with your final product for electrical safety of your product. As well, the products comply with the criteria of IEC62031:2008 as single LED package.

7-8. Recommended soldering Condition (This product is not adaptable to reflow process.)

-For manual soldering

Please use lead-free soldering.

Soldering shall be implemented using a soldering bit at a temperature lower than 350C, and shall be finished within 3.5 seconds for one land.

No external force shall be applied to resin part while soldering is implemented.

Next process of soldering should be carried out after the product has return to ambient temperature.

Contacts number of soldering bit should be within twice for each terminal.

* Citizen Electronics cannot guarantee if usage exceeds these recommended conditions.

Please use it after sufficient verification is carried out on your own risk if absolutely necessary.

-For more information, please refer to application note "Instruction Manual(COB LED Package)".

7-9. Eye Safety

-The International Electrical Commission (IEC) published in 2006 IEC 62471

”2006 Photobiological safety of lamps and lamp systems ” which includes LEDs within its scope.

When sorting single LEDs according to IEC 62471, almost all white LEDs can be classified as belonging to either Exempt Group (no hazard) or Risk Group 1 (low risk).

-However, Optical characteristics of LEDs such as radiant flux, spectrum and light distribution are factors that affect the risk group determination of the LED, and especially a high-power LED, that emits light containing blue wavelengths,

might have properties equivalent to those of Risk Group 2 (moderate risk).

-Great care should be taken when directly viewing an LED that is driven at high current, has multiple uses as a module or when focusing the light with optical instruments, as these actions might greatly increase the hazard to your eyes.

-It is recommended to regard the evaluation of stand-alone LED packages as a reference and to evaluate your final product.

7-10. This product is not designed for usage under the following conditions.

If the product might be used under the following conditions, you shall evaluate its effect and appropriate them. In places where the product might:

-directly and indirectly get wet due to rain and/or at place with the fear.

-be damage by seawater and/or at place with the fear

-be exposed to corrosive gas (such as Cl₂, H₂S, NH₃, SO_x, NO_x and so on) and/or at place with the fear.

-be exposed to dust, fluid or oil and/or at place with the fear.

Precautions with regard to product use

- (1)** This document is provided for reference purposes only so that CITIZEN ELECTRONICS' products are used as intended. CITIZEN ELECTRONICS neither makes warranties or representations with respect to the accuracy or completeness of the information contained in this document nor grants any license to any intellectual property rights or any other rights of CITIZEN ELECTRONICS or any third party with respect to the information in this document.
- (2)** All information included in this document such as product data, diagrams, charts, is current as of the date this document is issued.
Such information, however, is subject to change without any prior notice.
Before purchasing or using any CITIZEN ELECTRONICS' products listed in this document, please confirm the latest product information with a CITIZEN ELECTRONICS' sales office, and formal specifications must be exchanged and signed by both parties prior to mass production.
- (3)** CITIZEN ELECTRONICS has used reasonable care in compiling the information included in this document, but CITIZEN ELECTRONICS assumes no liability whatsoever for any damages incurred as a result of errors or omissions in the information included in this document.
- (4)** Absent a written signed agreement, except as provided in the relevant terms and conditions of sale for product, and to the maximum extent allowable by law, CITIZEN ELECTRONICS assumes no liability whatsoever, including without limitation, indirect, consequential, special, or incidental damages or loss, including without limitation, loss of profits, loss of opportunities, business interruption and loss of data, and disclaims any and all express or implied warranties and conditions related to sale, use of product, or information, including warranties or conditions of merchantability, fitness for a particular purpose, accuracy of information, or no infringement.
- (5)** Though CITIZEN ELECTRONICS works continually to improve products' quality and reliability, products can malfunction or fail. Customers are responsible for complying with safety standards and for providing adequate designs and safeguards to minimize risk and avoid situations in which a malfunction or failure of a product could cause loss of human life, bodily injury or damage to property, including data loss or corruption.
In addition, customers are also responsible for determining the appropriateness of use of any information contained in this document such as application cases not only with evaluating by their own but also by the entire system.
CITIZEN ELECTRONICS assumes no liability for customers' product design or applications.
- (6)** Please contact CITIZEN ELECTRONICS' sales office if you have any questions regarding the information contained in this document, or if you have any other inquiries.

CITIZEN Micro HumanTech is a registered trademark of Citizen Holding Co., Japan.
CITILED is a registered trademark of CITIZEN ELECTRONICS CO., LTD. Japan

- CITIZEN ELECTRONICS CO., LTD. shall not be liable for any disadvantages or damages resulting from the use of technical information or data included in this document or the impossibility of download and use, responsibility for the cause of lawsuit or any other damages or losses.
- This technical information or data shall be provided 'as is' to users and CITIZEN ELECTRONICS CO., LTD. does not guarantee the absence of error or other defects in this technical information or data, conformance of this technical information or data to specific purpose, this technical information or data or its use will not infringe the rights of users or third parties or any other content.
- CITIZEN ELECTRONICS CO., LTD. reserves the right to make changes to technical information or data without notification.

Information contained in this document such as sentences, photographs and images is subject to copyright, and is protected by law. Unless it is for "duplication for private use" or "quotation" under copyright law, any duplication or diversion of this information without permission of CITIZEN ELECTRONICS CO., LTD. is prohibited by law.

CITIZEN and  are trademarks or registered trademarks of CITIZEN HOLDINGS CO., LTD. JAPAN.
 is a trademark or a registered trademark of CITIZEN ELECTRONICS CO., LTD. JAPAN.



CITIZEN ELECTRONICS CO., LTD.

1-23-1, Kamikurechi, Fujiyoshida-shi, Yamanashi, 403-0001, Japan
Tel. +81-555-23-4121
<http://ce.citizen.co.jp>

Requests / Inquiries
inquiry@ce.citizen.co.jp

Website for LEDs for lighting
http://ce.citizen.co.jp/lighting_led/jp/