

CRYSTAL-RS

~5.1° spot beam. Assembly with holder.

TECHNICAL SPECIFICATIONS:

Dimensions	Ø 49.7 mm
Height	28.7 mm
Fastening	pin, screw
Colour	white
Box size	
Box weight	0 kg
Quantity in Box	288 pcs
ROHS compliant	yes ⓘ



MATERIAL SPECIFICATIONS:

Component	Type	Material	Colour
CRYSTAL-RS	Lens	PMMA	clear
CRYSTAL-HLD	Holder	PC	white

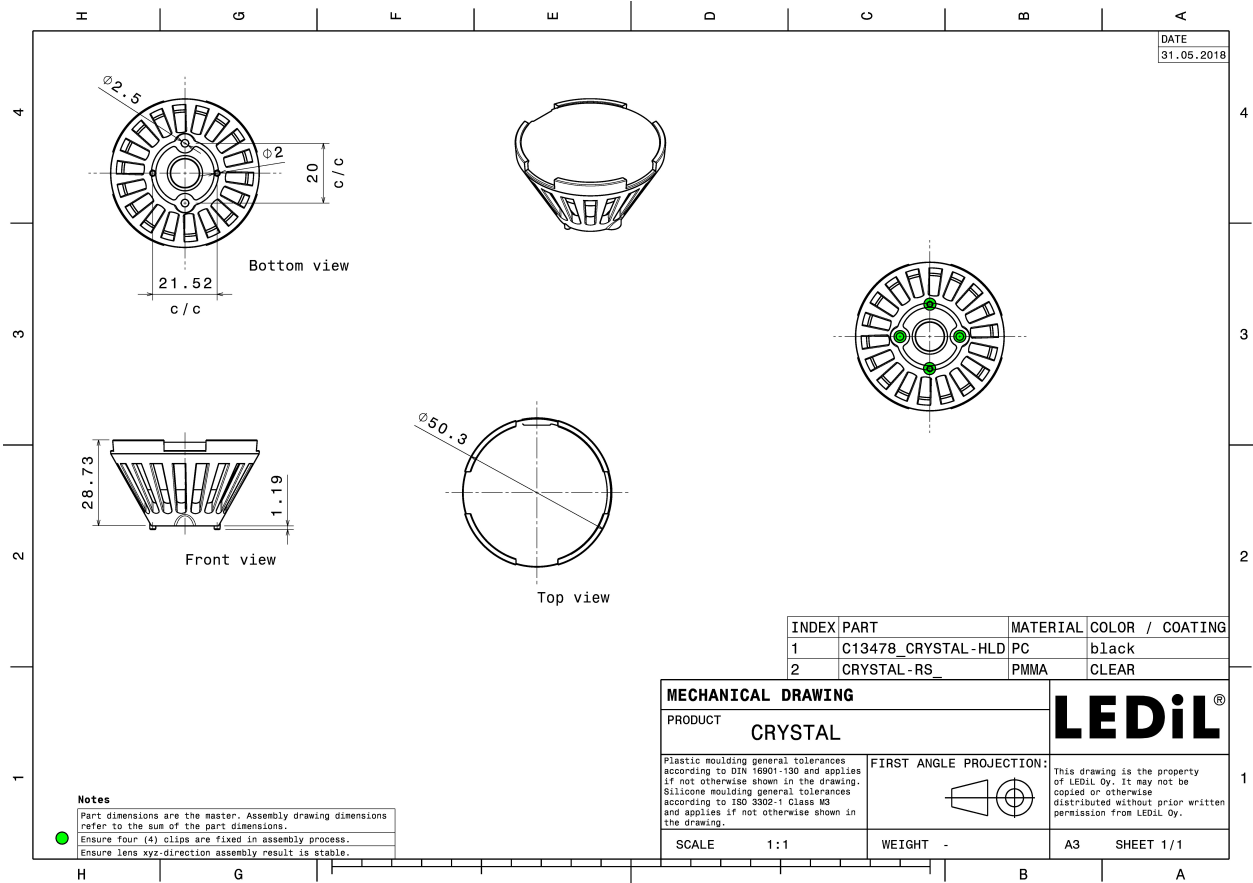

PHOTOMETRIC DATA (MEASURED):

CREE ⇄

LED XHP35 HI
 FWHM 5.7°
 Efficiency 89 %
 Peak intensity 48.300 cd/lm
 Required components:

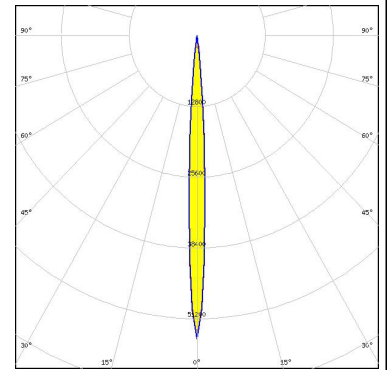
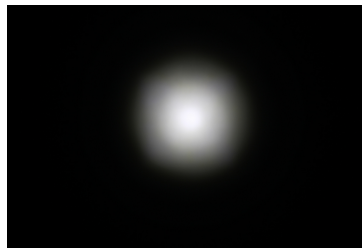

CREE ⇄

LED XP-G
 FWHM 4.9°
 Efficiency 89 %
 Peak intensity 68.290 cd/lm
 Required components:

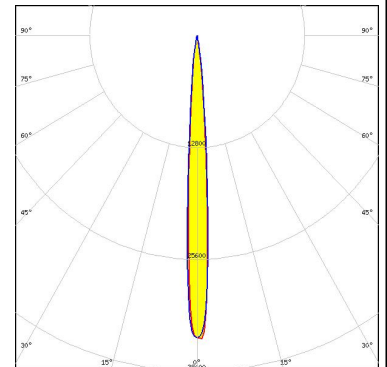

CREE ⇄

LED XP-L
 FWHM 7.0°
 Efficiency 88 %
 Peak intensity 34.700 cd/lm
 Required components:



CREE ⇄

LED XQ-E HI
 FWHM 2.9°
 Efficiency 88 %
 Peak intensity 110.500 cd/lm
 Required components:

PHOTOMETRIC DATA (MEASURED):

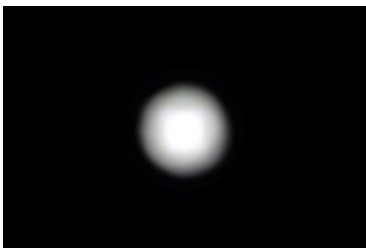
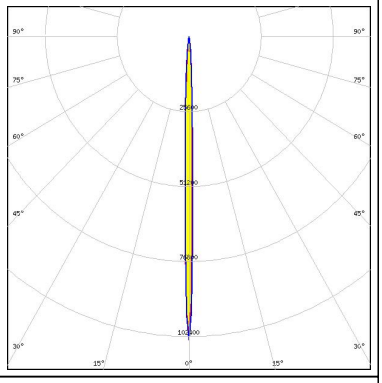
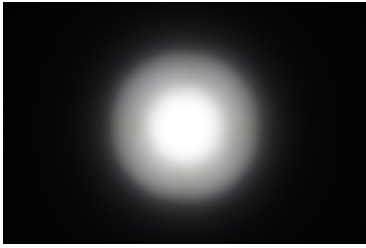
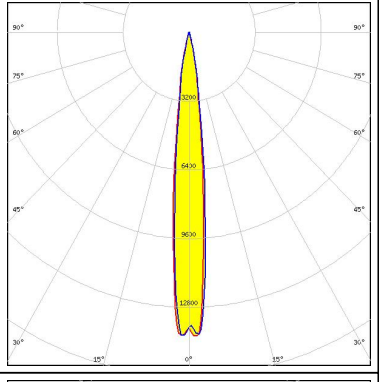
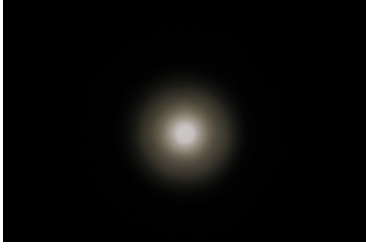
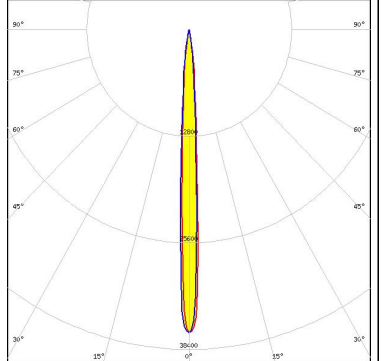
<p>LUMILEDS</p> <p>LED LUXEON A</p> <p>FWHM 5.1°</p> <p>Efficiency 89 %</p> <p>Peak intensity 58.900 cd/lm</p> <p>Required components:</p>		
<p>LUMILEDS</p> <p>LED LUXEON Z ES</p> <p>FWHM 3.0°</p> <p>Efficiency 93 %</p> <p>Peak intensity 103.780 cd/lm</p> <p>Required components:</p>		
<p>NICHIA</p> <p>LED NV4x144A</p> <p>FWHM 12.0°</p> <p>Efficiency 92 %</p> <p>Peak intensity 14.200 cd/lm</p> <p>Required components:</p>		
<p>NICHIA</p> <p>LED NVSW3x9A</p> <p>FWHM 6.0°</p> <p>Efficiency 89 %</p> <p>Peak intensity 36.500 cd/lm</p> <p>Required components:</p>		

PHOTOMETRIC DATA (MEASURED):



LED NVSxx19B/NVSxx19C
FWHM 5.3°
Efficiency 89 %
Peak intensity 42.500 cd/lm
Required components:

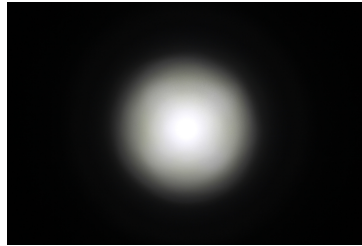

LED NWSx229A
FWHM 8.0°
Efficiency 92 %
Peak intensity 27.900 cd/lm
Required components:

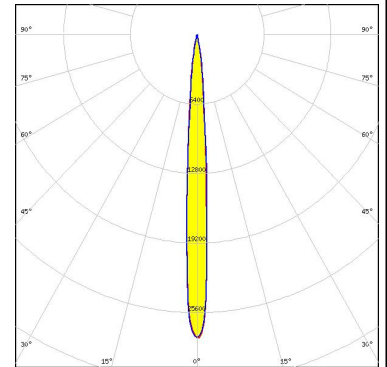

SAMSUNG

LED LH351B
FWHM 5.3°
Efficiency 90 %
Peak intensity 57.030 cd/lm
Required components:

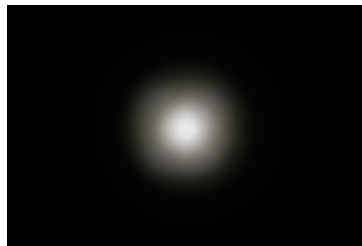

SAMSUNG

LED LH351Z
FWHM 4.4°
Efficiency 90 %
Peak intensity 77.000 cd/lm
Required components:



PHOTOMETRIC DATA (SIMULATED):

CREE 

LED XP-L HI
 FWHM 5.6°
 Efficiency 94 %
 Peak intensity 70.220 cd/lm
 Required components:

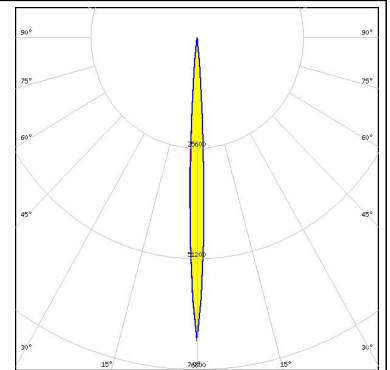

OSRAM

LED SFH 4717AS
 FWHM 6.7°
 Efficiency 94 %
 Peak intensity 46.450 cd/lm
 Required components:

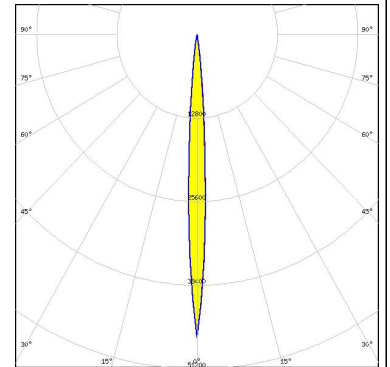
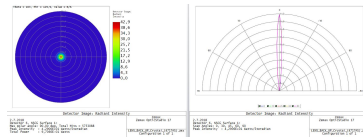

OSRAM

LED SFH 4727AS
 FWHM 6.7°
 Efficiency 94 %
 Peak intensity 47.000 cd/lm
 Required components:

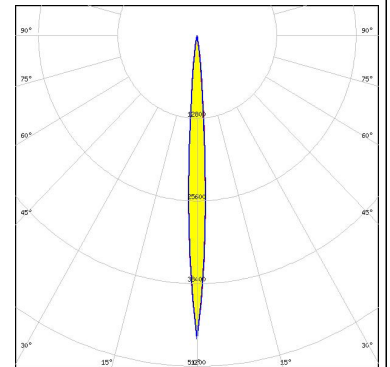
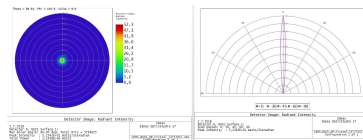

GENERAL INFORMATION:

NOTE: The typical beam angle will be changed by different color, chip size and chip position tolerance. The typical total beam angle is the full angle measured where the luminous intensity is half of the peak value.

MATERIALS:

As part of our continuous research and improvement processes, and to ensure the best possible quality and availability of our products, LEDiL reserves the right to change material grades without notice.

PRODUCT DATA USER AGREEMENT AND DISCLAIMER:

The measured data in the provided downloadable LEDiL Product Datasheets and Mechanical 2D-Drawings is rounded and provided as reference for planning. LEDiL Oy's optical specifications have been verified by conducting performance testing of the products in accordance with the company's quality system. The reported data are averaged results of multiple measurements with typical variation. LEDiL Oy reserves the right to without prior notification make changes and improvements to its products.

LEDiL Oy assumes neither warranty, nor guarantee nor any other liability of any kind for the contents and correctness of the provided data. The provided data has been generated with highest diligence but the provided data may in reality not represent the complete possible variation range of all intrinsic parameters. Therefore, in certain cases a deviation from the provided data could occur.

LEDiL Oy reserves the right to undertake technical changes of its products without further notification which could lead to changes in the provided data. LEDiL Oy assumes no liability of any kind for the possible deviation from any provided data or any other damage resulting from the usage of the provided data.

The user agrees to this disclaimer and user agreement with the download or usage of the provided files.

LEDiL Oy

Joensuunkatu 13
FI-24240 SALO
Finland

LEDiL Inc.

228 West Page Street
Suite D
Sycamore IL 60178
USA

Local sales and technical support

[www.ledil.com/
where_to_buy](http://www.ledil.com/where_to_buy)

Shipping locations

Salo, Finland
Hong Kong, China

Distribution Partners

[www.ledil.com/
where_to_buy](http://www.ledil.com/where_to_buy)