



Micro Commercial Components

Micro Commercial Components  
20736 Marilla Street Chatsworth  
CA 91311  
Phone: (818) 701-4933  
Fax: (818) 701-4939

**EGP30A  
THRU  
EGP30K**

**3.0 Amp Glass  
Passivated High  
Efficient Rectifiers  
50 to 800 Volts**

**Features**

- Superfast recovery time for high efficiency
- Glass passivated cavity-free junction, Plastic case
- Lead Free Finish/RoHS Compliant (Note1) ("P" Suffix designates Compliant. See ordering information)
- Marking : Cathode band and type number
- Case Material: Molded Plastic. UL Flammability Classification Rating 94V-0 and MSL rating 1

**Maximum Ratings**

- Operating Temperature: -55°C to +150°C
- Storage Temperature: -55°C to +150°C
- Typical Thermal Resistance: 20°C/W Junction to Ambient

MCC Part Number	Maximum Recurrent Peak Reverse Voltage	Maximum RMS Voltage	Maximum DC Blocking Voltage
EGP30A	50V	35V	50V
EGP30B	100V	70V	100V
EGP30D	200V	140V	200V
EGP30F	300V	210V	300V
EGP30G	400V	280V	400V
EGP30J	600V	420V	600V
EGP30K	800V	560V	800V

**Electrical Characteristics @ 25°C Unless Otherwise Specified**

Maximum Average Forward Current	$I_{F(AV)}$	3.0 A	$T_A = 55^\circ\text{C}$	
Peak Forward Surge Current	$I_{FSM}$	125A	8.3ms, half sine	
Maximum Instantaneous Forward Voltage	$V_F$	EGP30A-30D EGP30F-30G EGP30J-30K	$I_F=3.0\text{A}$ $T_A=25^\circ\text{C}$	
Maximum DC Reverse Current At Rated DC Blocking Voltage		$I_R$	5.0uA 100uA	$T_A=25^\circ\text{C}$ $T_A=125^\circ\text{C}$
Reverse Recovery Time		$T_{rr}$	EGP30A-30G EGP30J-30K	$T_A=25^\circ\text{C}$ $I_F=0.5\text{A}, I_R=1.0\text{A},$ $I_T=0.25\text{A}$
Typical Junction Capacitance	$C_J$		EGP30A-30D EGP30F-30K	Measured at $f=1.0\text{MHz}$ $V_R=4.0\text{V}$

Note:1. High Temperature Solder Exemption Applied, see EU Directive Annex 7.

**DO-201AD**

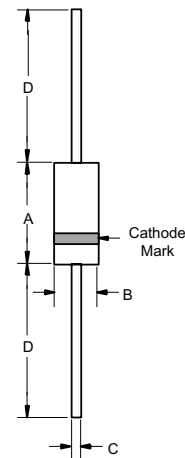

DIM	INCHES		MM		NOTE
	MIN	MAX	MIN	MAX	
A	.287	.374	7.30	9.50	
B	.189	.208	4.80	5.30	
C	.048	.052	1.20	1.30	
D	1.000	---	25.40	---	

# EGP30A thru EGP30K

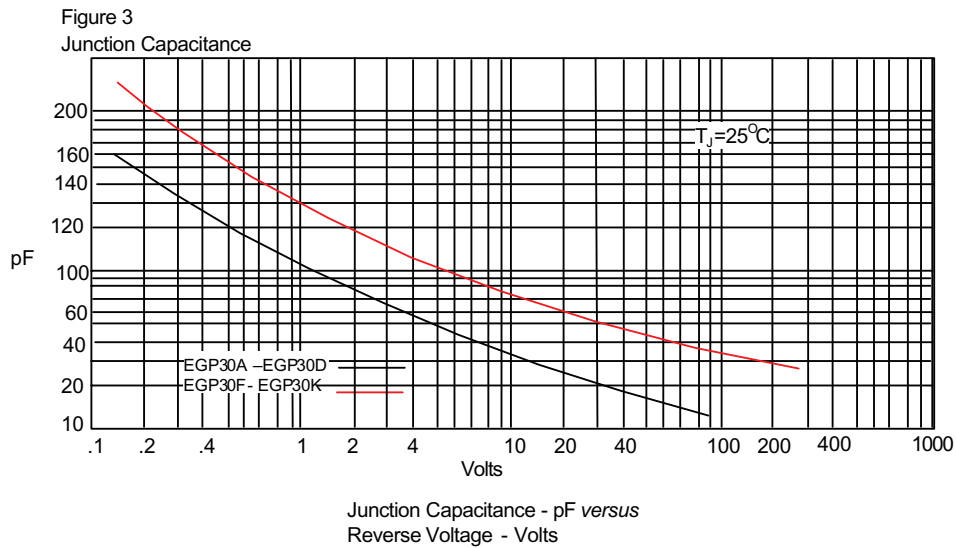
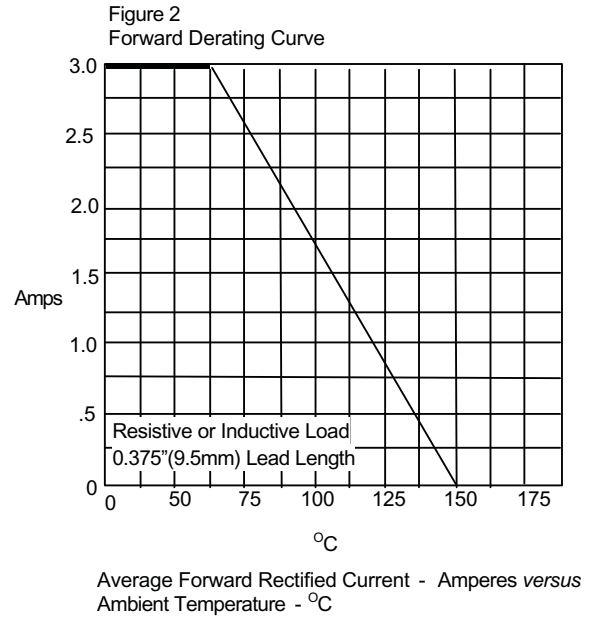
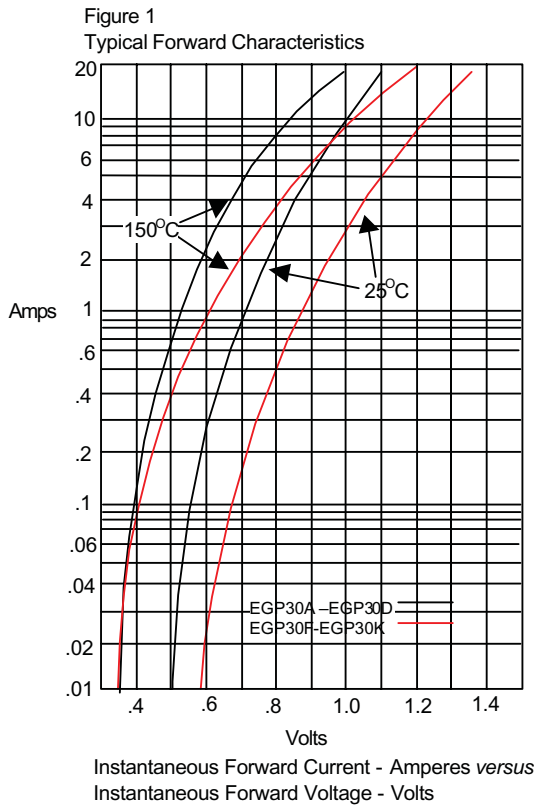

# EGP30A thru EGP30K

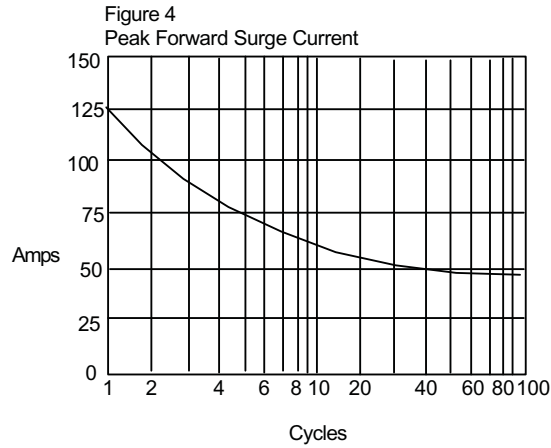

Peak Forward Surge Current - Amperes versus Number Of Cycles At 60Hz - Cycles

Figure 5  
Reverse Recovery Time Characteristic And Test Circuit Diagram

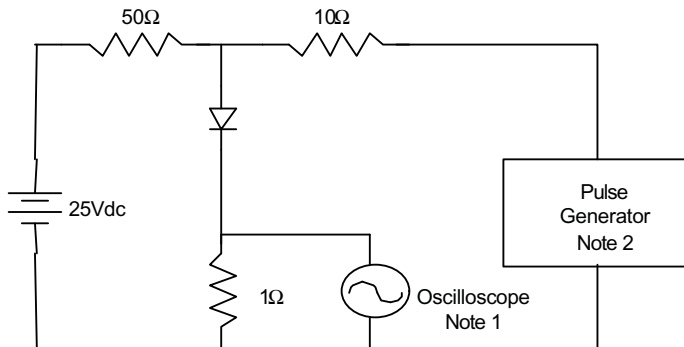

- Notes:
1. Rise Time = 7ns max.  
Input impedance = 1 megohm, 22pF
  2. Rise Time = 10ns max.  
Source impedance = 50 ohms
  3. Resistors are non-inductive

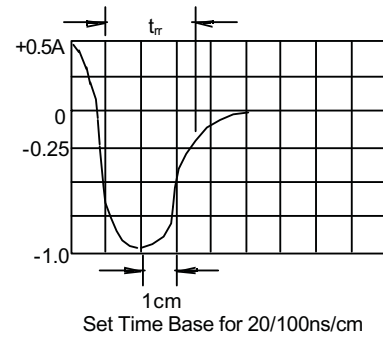



Micro Commercial Components

## Ordering Information

Device	Packing
(Part Number)-TP	Tape&Reel; 1.2Kpcs/Reel
(Part Number)-AP	Ammo Packing;1.2Kpcs/AmmoBox
(Part Number)-BP	Bulk;500pcs/Box

### \*\*\*IMPORTANT NOTICE\*\*\*

*Micro Commercial Components Corp.* reserves the right to make changes without further notice to any product herein to make corrections, modifications, enhancements, improvements, or other changes. *Micro Commercial Components Corp.* does not assume any liability arising out of the application or use of any product described herein; neither does it convey any license under its patent rights, nor the rights of others. The user of products in such applications shall assume all risks of such use and will agree to hold *Micro Commercial Components Corp.* and all the companies whose products are represented on our website, harmless against all damages.

### \*\*\*APPLICATIONS DISCLAIMER\*\*\*

Products offer by *Micro Commercial Components Corp.* are not intended for use in Medical, Aerospace or Military Applications.