



User Manual

ConBee





Table of contents

1. Overview.....	6
2. Applications.....	6
3. Features.....	6
3.1. Short facts.....	6
3.2. How does the USB Dongle work?.....	7
4. Quick start.....	8
4.1. Content of delivery.....	8
4.2. Shipping Software.....	8
4.3. Requirements.....	8
4.3.1. Supported Operating Systems.....	8
4.4. Installing drivers.....	8
4.4.1. Windows.....	8
4.4.2. Linux.....	9
4.5. Using the USB Dongle with deCONZ application.....	9
4.5.1. Windows.....	9
4.5.2. Raspbian Linux.....	11
4.5.3. Ubuntu Linux.....	13
4.6. WebApp on Mobile devices.....	17
5. Installing individual firmware with GCFFlasher.....	17
5.1. Windows.....	18
5.2. Raspbian Linux.....	18
5.3. Ubuntu Linux.....	20
5.4. Notes on custom firmware.....	21
5.5. Example with BitCatcher.....	22
5.5.1. Software.....	22
5.5.2. Firmware.....	22
5.6. EEPROM layout.....	22
5.7. Fuse settings.....	22
6. Technical data.....	23
6.1. Output power and channel settings.....	25
7. Pin assignment.....	26



8.	Hardware modifications for development	28
8.1.	Assemble the program header	28
8.2.	Assemble the trace header.....	28
8.3.	Assemble the Serial Flash Memory	29
8.4.	Assemble the User button	29
8.5.	Assemble the status LEDs	30
9.	Radio certification.....	31
9.1.	United States (FCC)	31
9.2.	European Union (ETSI)	31
9.3.	Approved antenna list.....	32
10.	Ordering information	32
11.	Revision notes.....	32
12.	References	33



Document history

Date	Version	Description
2016-06-15	1.0	Initial version
2016-09-30	1.1	Update deCONZ section for Ubuntu Linux Update GCFFlasher section for Ubuntu Linux Adding screenshots



Abbreviations

Abbreviation	Description
IEEE 802.15.4	Communication standard, applicable to low-rate Wireless Personal Area Networks (WPAN)
CE	Consumer Electronics
ETSI	European Telecommunications Standards Institute
FCC	Federal Communications Commission
GPIO	Generals Purpose Input Output
JTAG	Joint Test Action Group, digital interface for debugging of embedded devices, also known as IEEE 1149.1 standard interface
MAC	Medium (Media) Access Control
MCU, μ C	Microcontroller Unit
OS	Operating System
RF	Radio Frequency
RPi	Raspberry Pi, a famous inexpensive single board computer in credit card size
R&TTE	Radio and Telecommunications Terminal Equipment (Directive of the European Union)
U[S]ART	Universal [Synchronous/]Asynchronous Receiver Transmitter
ZigBee	Low-cost, low-power wireless mesh network standard. The ZigBee Alliance is a group of companies that maintain and publish the ZigBee standard.
ZHA	ZigBee Home Automation profile
ZLL	ZigBee Light Link profile



1. Overview

The ConBee is the platform independent USB Dongle that turns your host into a full functional wireless node which can be seamlessly integrated into ZigBee networks. This will enhance the application range of your host with monitoring and controlling ZigBee networks. ZigBee compatible devices are available from a lot of manufacturers.

This USB Dongle contains a powerful radio module with integrated power amplifier and low noise amplifier. Together with the assembled onboard chip antenna which has been optimally tuned ensures a superior RF performance.

The ConBee is shipped with a bootloader application for simple firmware uploads and updates.

The ZigBee firmware is interfaced by a software called deCONZ which runs on Windows and Linux and is responsible for ZigBee network control and monitoring.

2. Applications

Mainly the ConBee is designed to handle ZigBee Light Link (ZLL) and ZigBee Home Automation (ZHA) applications in connection with the ZigBee firmware and software deCONZ. A more detailed description of the ZLL standard, the features, benefits and available certified products can be found on the official alliance website **[1]**.

It is also possible to use a custom firmware for wireless applications. Follow the instructions in **Section 5** and **Section 10** for detailed instructions on software installation and customer modifications.

Note: Please note that depending on the modifications the radio certification and compliance may become invalid. Please get in contact with us to advise you for a custom FCC certified and/or compliant design.

3. Features

The ConBee contains the features listed below. **Figure 1** illustrates the feature parts in a detailed view.

3.1. Short facts

- Slim size: 70.7 x 23.0 x 8.3 mm
- Supply voltage: USB powered 5.0V / DC
- Onboard 2.4 GHz ZigBee radio module 'deRFmega256-23M12'
- Application interfaces: USB

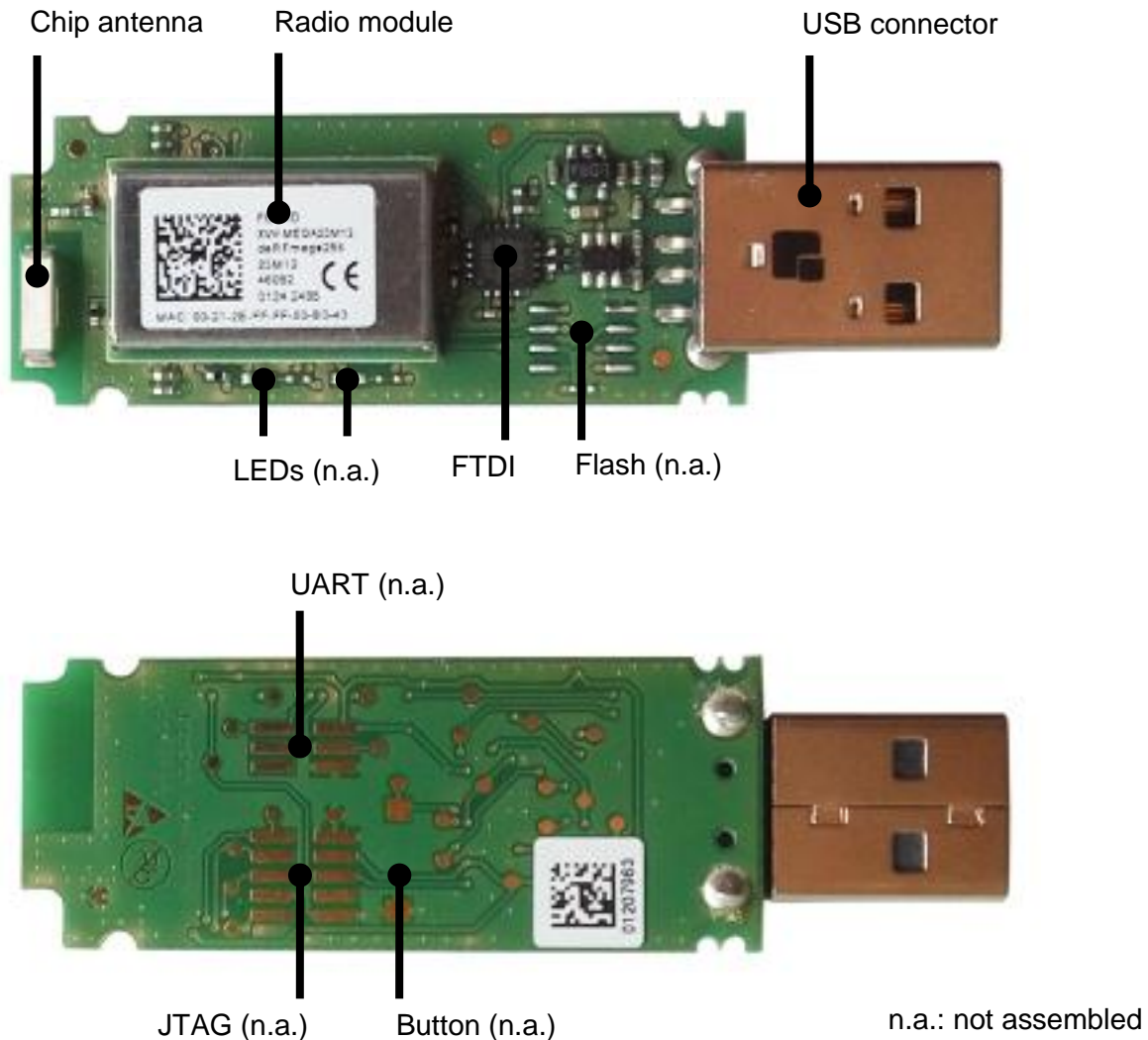

Figure 1: ConBee in detail

3.2. How does the USB Dongle work?

The functional parts of the ConBee are shown in a schematic overview in **Figure 2**.

The USB Dongle will be supplied by the USB 5.0 V domain. Therefore the USB power supply must be sufficient to support the additional load. An onboard low-drop-out voltage regulator generates a stable 3.3 V voltage to supply the radio module on the USB Dongle.

The onboard placed radio module deRFmega256-23M12 by dresden elektronik contains an 8-bit AVR microcontroller with an integrated low-power 2.4 GHz transceiver for ZigBee and IEEE 802.15.4 applications. The ConBee is shipped with bootloader software and pre-installed ZigBee firmware. Each USB Dongle contains a world-wide unique identifier, named MAC-ID. It consists of an 8 byte address, including the vendor ID and product ID. The MAC-ID is stored in the MCU internal EEPROM.



The RF output signal of the 2.4 GHz radio module is routed to the assembled onboard chip antenna.

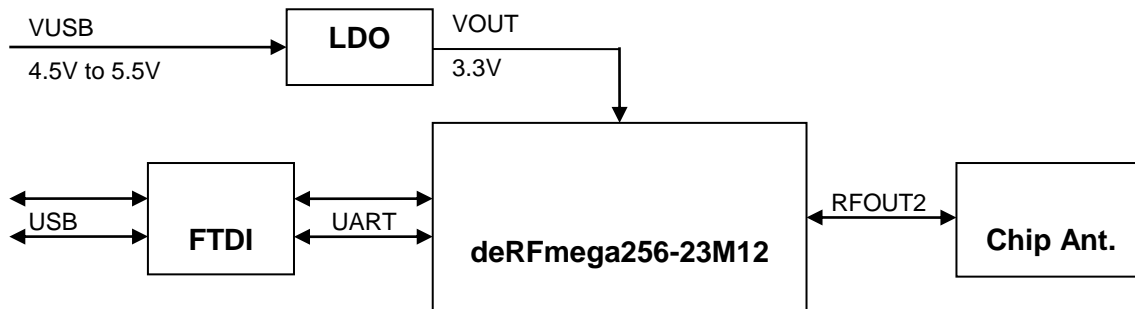

Figure 2: Block Diagram

4. Quick start

This section describes in short steps a fast start-up of the ConBee to control and monitor a ZigBee network.

4.1. Content of delivery

One shipped USB Dongle package contains the following:

- 1x ConBee - USB Dongle
- 1x Instruction leaflet

4.2. Shipping Software

The ConBee is shipped with bootloader software and pre-installed ZigBee firmware.

4.3. Requirements

The ConBee needs a dedicated USB port with up to 500mA current supply and works on desktop PCs, laptops and the Single Board Computer Raspberry Pi 1, 2 and 3.

4.3.1. Supported Operating Systems

- Microsoft Windows 7, 8, 8.1 and 10
- Canonical Ubuntu Linux 16.04
- Raspberry Pi Raspian Wheezy and Jessie

4.4. Installing drivers

On most platforms the necessary USB COM port drivers by FTDI will be installed automatically when you plug in the USB Dongle. You can also download and install the FTDI drivers manually from <http://www.ftdichip.com/FTDrivers.htm>

4.4.1. Windows

Plug in the USB Dongle into a free USB port. On Windows the drivers will be installed automatically if you have activated automatic driver installation. A window will pop up where you can select automatic driver installation.



4.4.2. Linux

No further driver installation is needed. All common Linux distributions include the necessary COM port drivers.

4.5. Using the USB Dongle with deCONZ application

The deCONZ¹ application allows the configuration, operation, monitoring and maintenance of ZigBee networks.

4.5.1. Windows

1. Download and install the deCONZ software from:

<https://www.dresden-elektronik.de/funktechnik/products/software/pc/deconz/>

Important Note:

The next step will bring up a windows firewall warning. This happens because deCONZ runs a webserver to provide the WebApp and is using a discovery mechanism via Internet so that your devices can find the WebApp. For proper operation it's required to confirm the firewall exception.

2. Start the deCONZ application from the start menu.

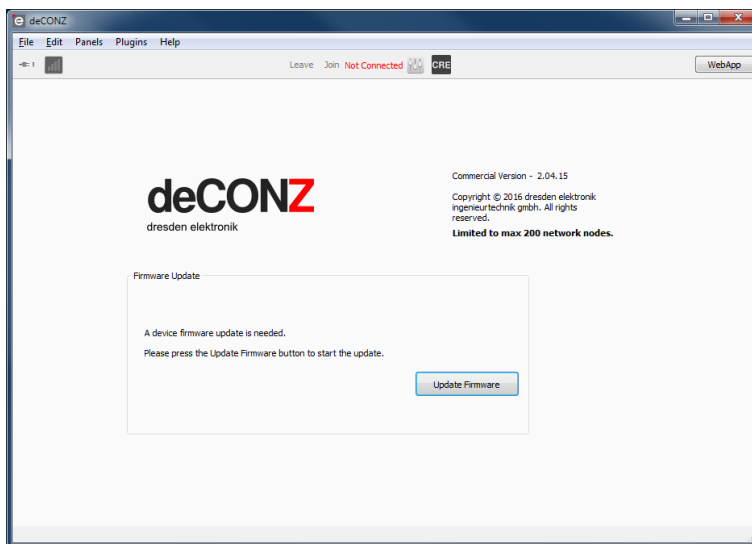

3. If necessary perform a ZigBee firmware update at first.

¹ See <https://www.dresden-elektronik.de/funktechnik/products/software/pc-software/deconz/>

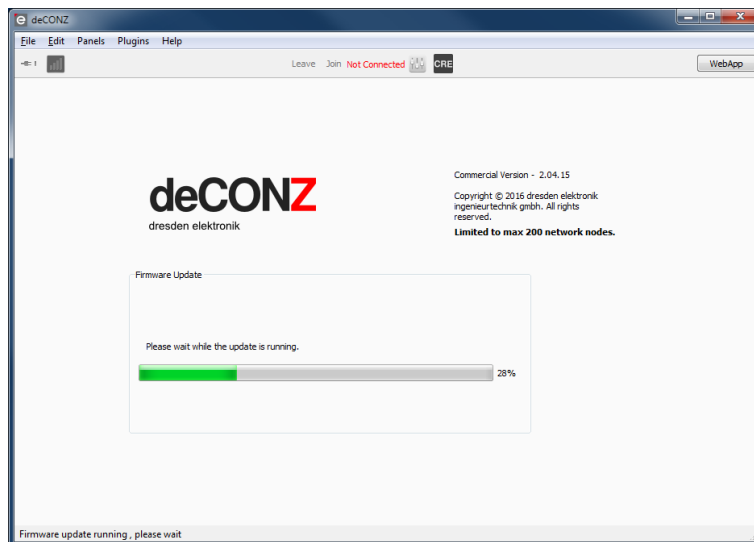

4. The application automatically connects to the USB Dongle and a blue coordinator node with address 0x0000 appears.

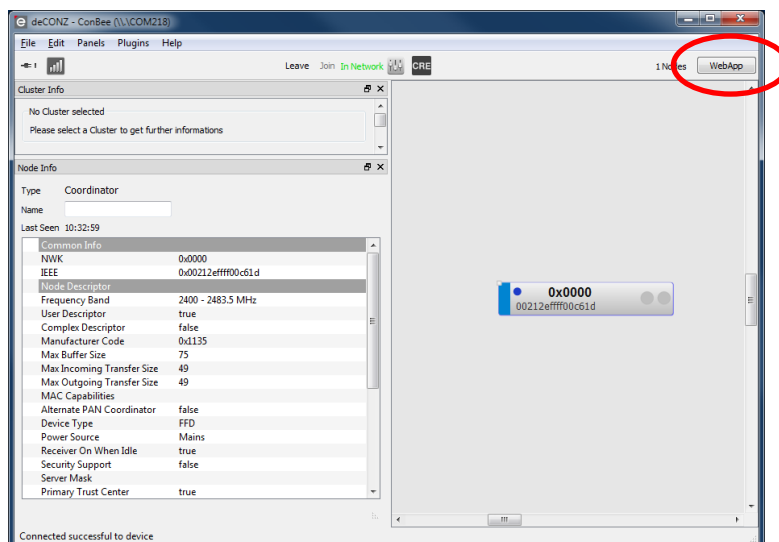

5. Press the WebApp button to open the browser based control software.
6. Login as user: *delight* and password: *delight*

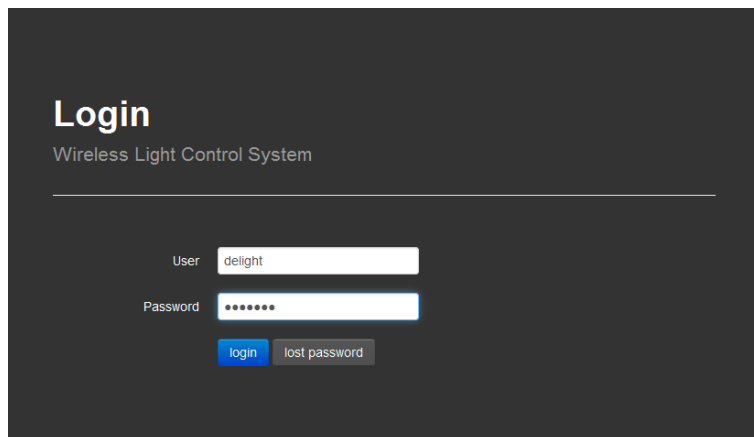

Refer to the Quick Start Guide for further instructions how to use the WebApp [3].

4.5.2. Raspbian Linux

Open the terminal window by

Menu / Accessories / Terminal

or shortcut STRG+ALT+T and type in the commands described in the sections above.

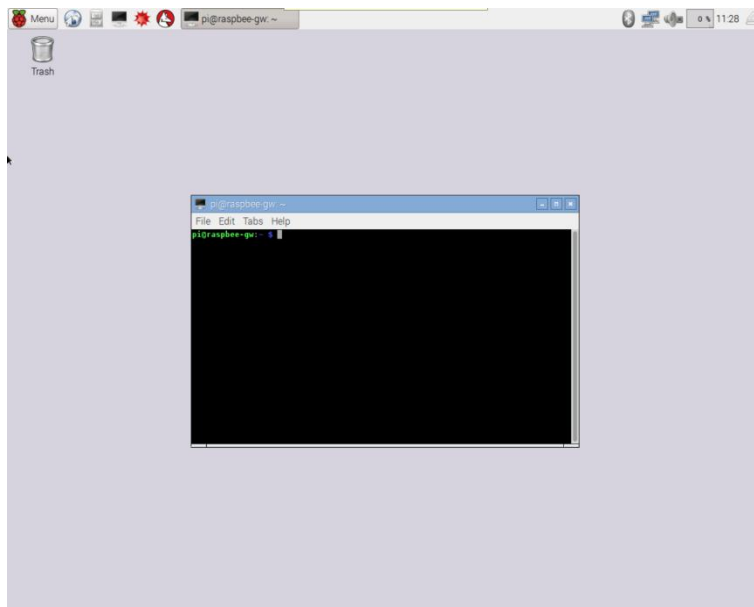

4.5.2.1. Required software packages

1. Download and install Qt 4.8:

```
$ sudo apt-get install libqt4-core
```

4.5.2.2. Download and install deCONZ

1. Download deCONZ software package:

```
$ wget http://www.dresden-elektronik.de/rpi/deconz/stable/deconz-latest.deb
```

2. Install deCONZ software package:



```
$ sudo dpkg -i deconz-latest.deb
```

4.5.2.3. Start and run the application

7. If not already running start the desktop environment

```
$ startx
```

8. Start the deCONZ application via start menu

Menu / Programming / deCONZ

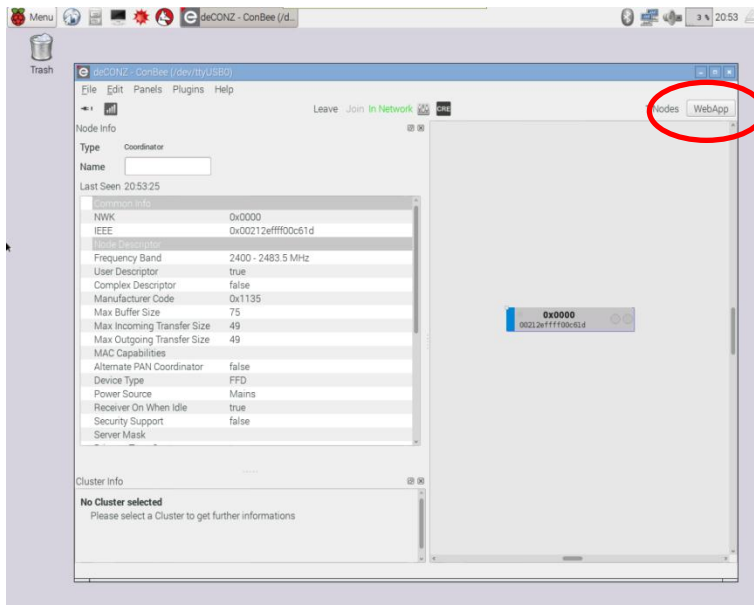

9. Press the WebApp button to open the browser based control software.

10. Login as user: *delight* and password: *delight*

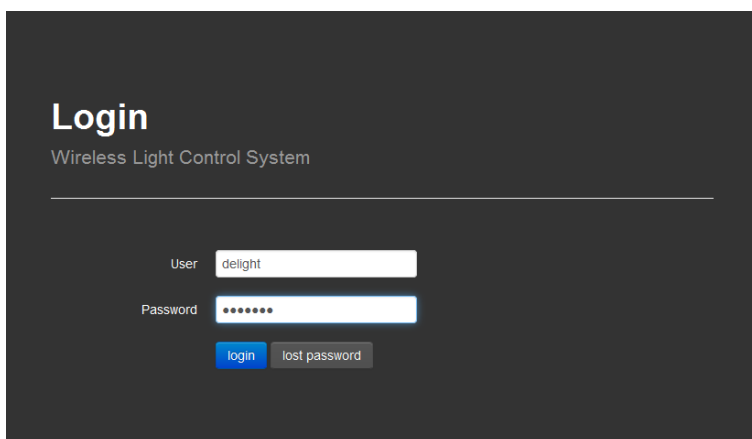

Refer to the Quick Start Guide for further instructions how to use the WebApp [3].

4.5.2.4. Execute the application at start-up

1. Create the folder "autostart":

```
$ mkdir -p /home/pi/.config/autostart/
```



2. Create and edit the file “deCONZ.desktop”:

```
$ leafpad /home/pi/.config/autostart/deCONZ.desktop
```

3. Insert the following lines and save the file:

```
[Desktop Entry]
Type=Application
Name=deCONZ
Exec=deCONZ-autostart.sh
StartupNotify=false
```

Now, the application will run automatically after start-up of the Raspberry Pi.

4.5.3. Ubuntu Linux

4.5.3.1. Required Software Package

The required software package Qt 5 will be installed by the deCONZ application automatically.

4.5.3.2. Download and install deCONZ

1. Download the latest deCONZ (Ubuntu Linux) software from:

<https://www.dresden-elektronik.de/funktechnik/products/software/pc/deconz>

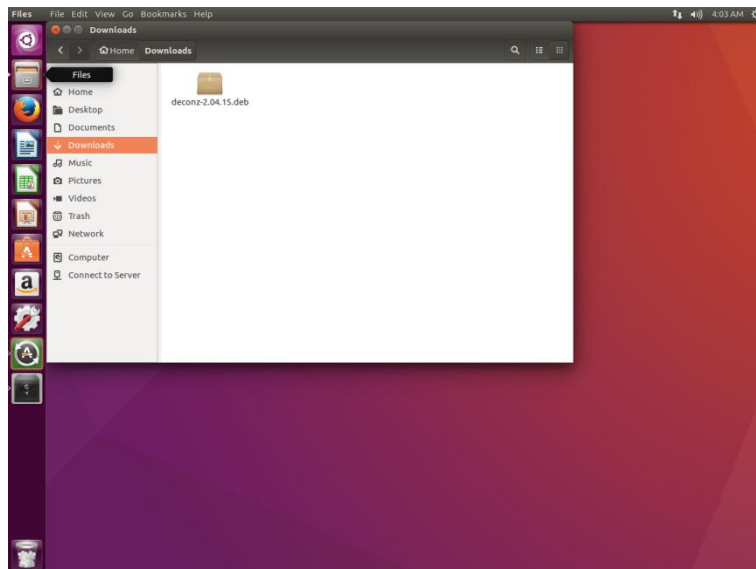

2. Open the terminal window by STRG+ALT+T and type in the commands:

```
$ cd Downloads
```

```
$ sudo dpkg -i deconz-2.04.15.deb
```

Confirm with your user password if necessary.

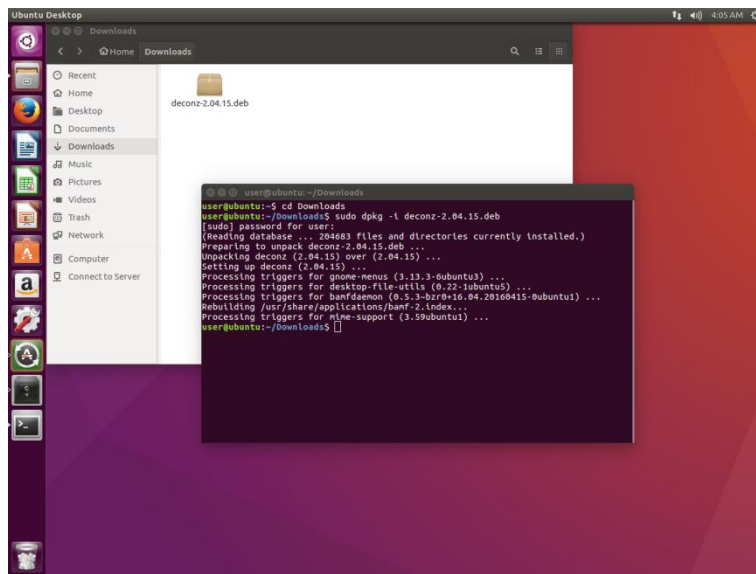

3. Start the deCONZ application by the search input.

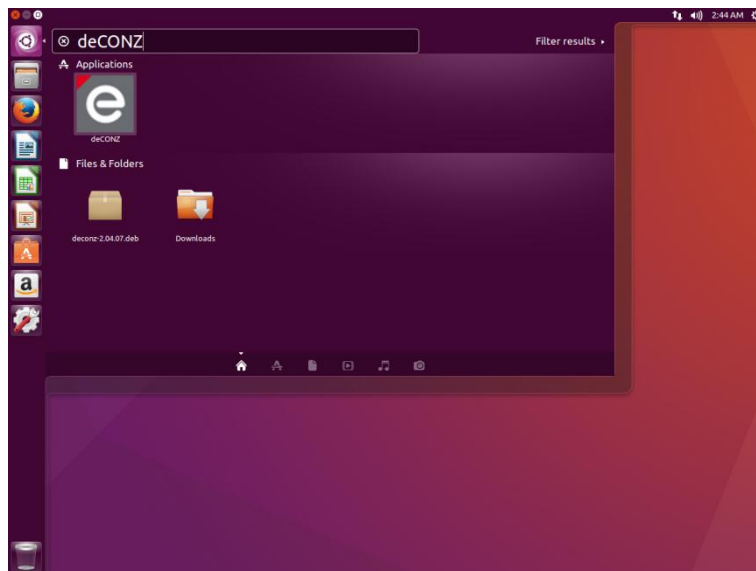

4. The application automatically connects to the USB Dongle.
5. The application checks the firmware of the USB Dongle and will request an update if necessary. Proceed by performing the firmware update.

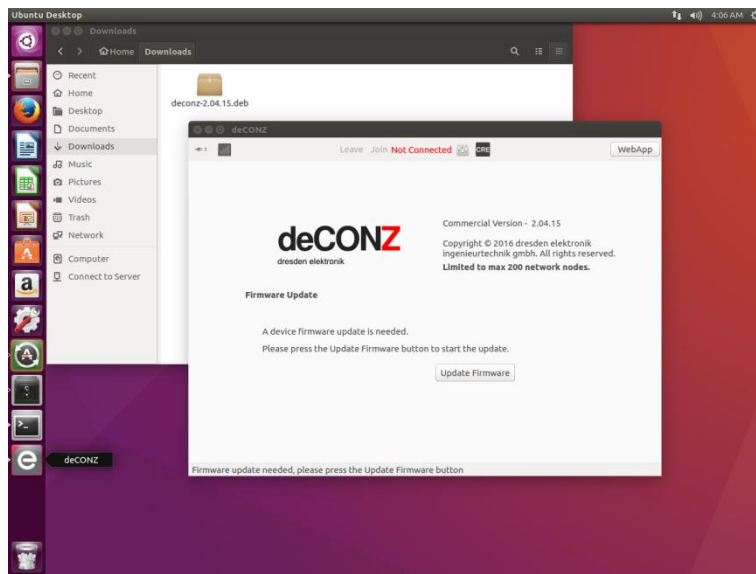

6. Do not disconnect the USB dongle during the update process.

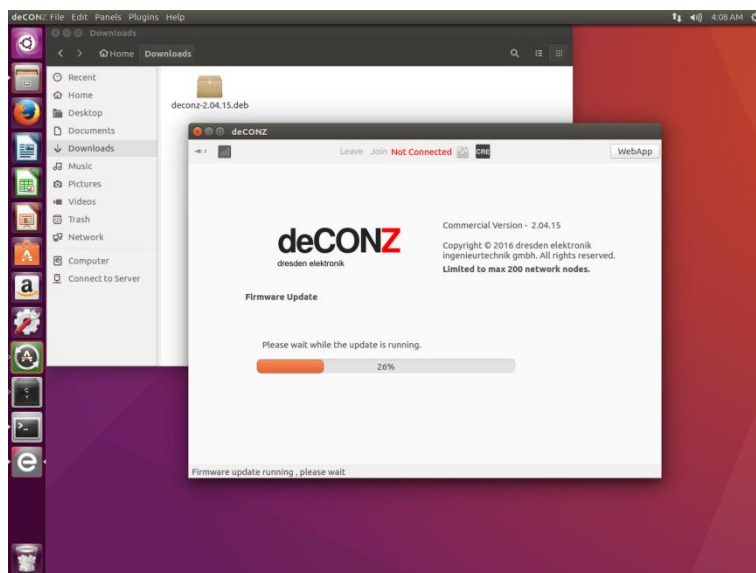

7. The application automatically connects to the USB Dongle and a blue coordinator node with address 0x0000 appears.

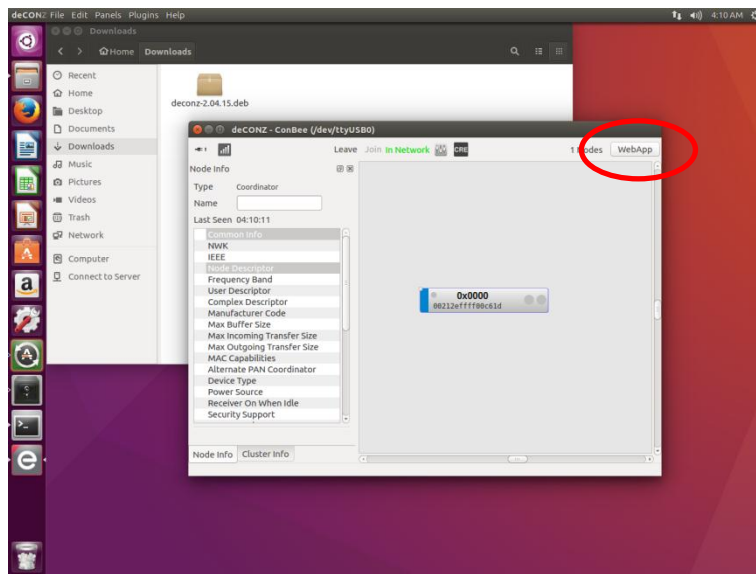

8. Press the WebApp button to open the browser based control software.
9. Login as user: *delight* and password: *delight*

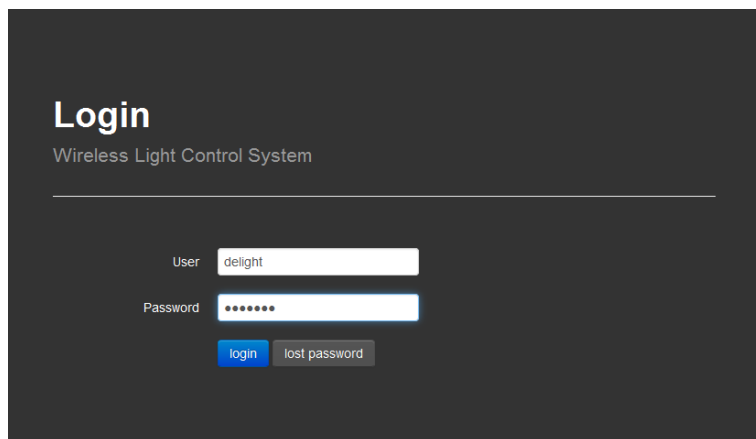

Refer to the Quick Start Guide for further instructions how to use the WebApp [3].

10. After restarting the operating system password entries are no longer necessary. The deCONZ application can be found and started by the search input.

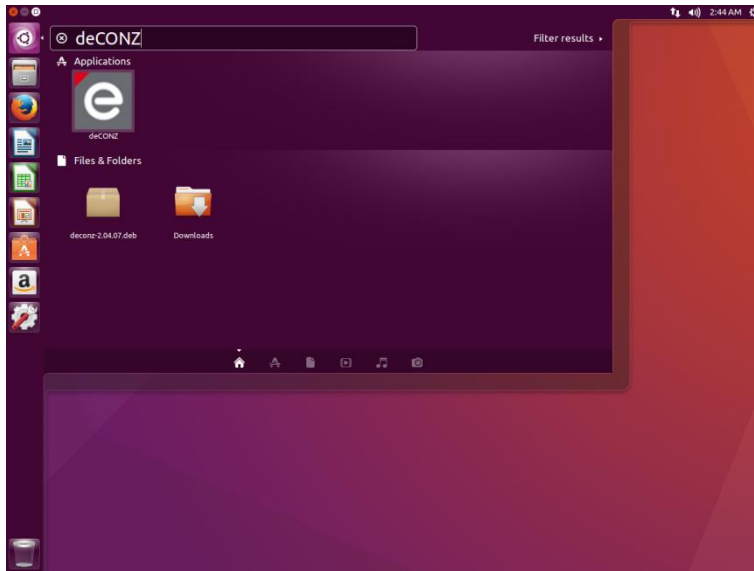

4.6. WebApp on Mobile devices

The browser based WebApp can be used on Mobile devices to control a Wireless Lighting System with the ConBee.

Requirements:

1. The host system with the connected ConBee needs an established internet connection.
2. If applicable activate the “Internet Service” of the WebApp. Refer to the Quick Start Guide of the WebApp [3] in section “System settings”.
3. The host system and Mobile device must be work in the same network, e.g. home network with WiFi router.

Execution:

1. Open the Mobile device browser and navigate to <http://www.dresden-elektronik.de/discover/> and choose your device.

Save the discovery page and/or the ConBee’s WebApp link as bookmark in the browser for a faster access.

5. Installing individual firmware with GCFFlasher

GCFFlasher is a command line tool which can be used to update the USB Dongle without additional programming hardware. It is also used by deCONZ to update the ZigBee firmware. The GCFFlasher communicates with the USB Dongle bootloader via COM port interface.

Note 1: GCFFlasher accepts firmware files in binary file format (.bin) and in dresden elektronik’s proprietary GCF file format. There is no EEPROM programming support within GCFFlasher. EEPROM programming must be done within your application code. Please note that modifying the EEPROM may cause irreversibly damage to your USB Dongle. Use with care. GCFFlasher also provides the option ‘-r’ to power cycle the target device.



Note 2: It is not possible to perform the update while running the deCONZ application. Therefore it is necessary to close the deCONZ application before updating the firmware with GCFFlasher.

Note 3: For help on the GCFFlasher options run: `GCFFlasher -h`

5.1. Windows

1. Download GCFFlasher (Windows) from:

<https://www.dresden-elektronik.de/funktechnik/service/downloads/software>

2. Unzip the package and double click the GCFFlasherCommandline.bat file. A command prompt will open and output a list of all connected device(s).

```
C:\Windows\system32\cmd.exe
GCFFlasher U2_02 (c) dresden elektronik ingenieurtechnik gmbh 2016/05/04
1 FTDI device found
-----
device | vendor | product | serial | description
-----
0      | 0x0403 | 0x6015  | DJ00Q40T | FT230X Basic UART
-----
C:\Users\admin\Desktop\GCFFlasher_U2_02>
```

3. Put the firmware file in the same folder as GCFFlasher.exe

4. To upload the firmware, invoke GCFFlasher from the command prompt as follows:

```
GCFFlasher -d <device> -f <YourApplication.bin[.GCF]>
```

For example:

```
GCFFlasher -d 0 -f deCONZ_0x26050500.bin.GCF
```

```
C:\Windows\system32\cmd.exe
GCFFlasher U2_02 (c) dresden elektronik ingenieurtechnik gmbh 2016/05/04
1 FTDI device found
-----
device | vendor | product | serial | description
-----
0      | 0x0403 | 0x6015  | DJ00Q40T | FT230X Basic UART
-----
C:\Users\admin\Desktop\GCFFlasher_U2_02>GCFFlasher.exe -d 0 -f deCONZ_Rpi_0x26030500.bin.GCF
GCFFlasher U2_02 (c) dresden elektronik ingenieurtechnik gmbh 2016/05/04
using firmware file: deCONZ_Rpi_0x26030500.bin.GCF
reset via FTDI
> READY < (5)
flashing 122624 bytes: |=====|
verify: ...
SUCCESS
C:\Users\admin\Desktop\GCFFlasher_U2_02>
```

Note: You can list the devices with: `GCFFlasher -l`

5.2. Raspbian Linux

Open the terminal window by STRG+ALT+T and type in the commands described in the sections above.

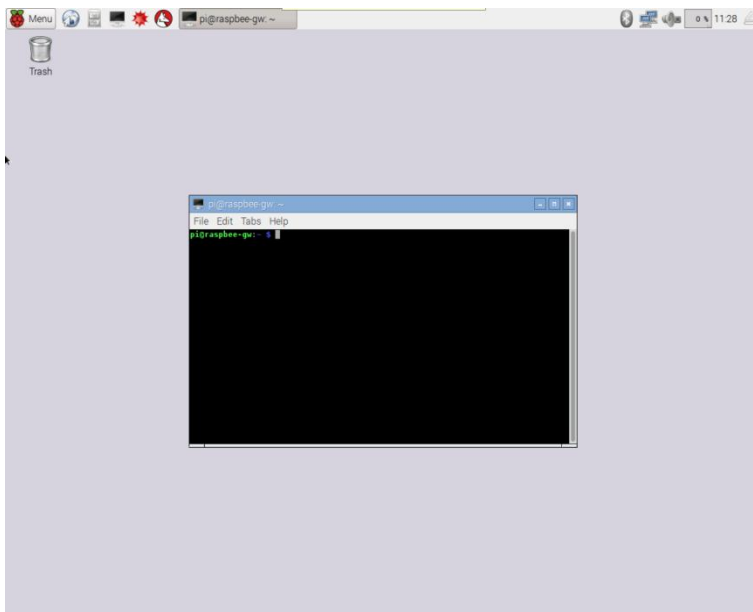

5.2.1.1. Required software packages

1. Download and install Qt 4.8

```
$ sudo apt-get install libqt4-core
```

5.2.1.2. Download and install GCFFlasher

1. Download GCFFlasher

```
$ wget http://www.dresden-  
elektronik.de/rpi/gcflasher/gcflasher-latest.deb
```

2. Install GCFFlasher

```
$ sudo dpkg -i gcflasher-latest.deb
```

3. To upload the firmware, invoke GCFFlasher (superuser rights required) as follows:

```
$ sudo GCFFlasher -d <device> -f <YourApplication.bin[.GCF]>
```

For example:

```
$ sudo GCFFlasher -d 0 -f deCONZ_0x26050500.bin.GCF
```

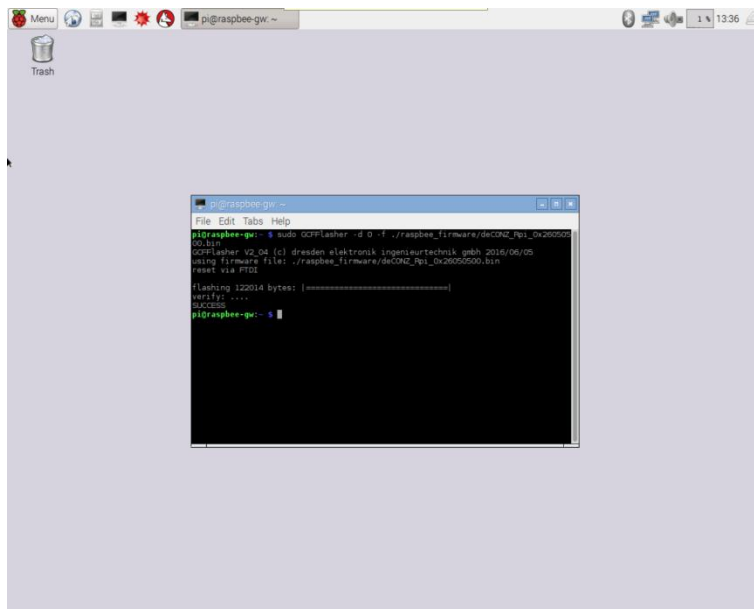

Note: You can list all devices with: `$ sudo GCFFlasher -l`

5.3. Ubuntu Linux

5.3.1.1. Required software packages

1. Download and install Qt 4.8

```
$ sudo apt-get install libqt4-core
```

5.3.1.2. Download and install GCFFlasher

1. Download GCFFlasher (Ubuntu Linux) from:
<https://www.dresden-elektronik.de/funktechnik/service/downloads/software>
2. Open the terminal window by STRG+ALT+T and type in the commands:

```
$ cd Downloads
```

```
$ sudo dpkg -i gcfflasher-2.08.deb
```

Confirm with your user password if necessary.

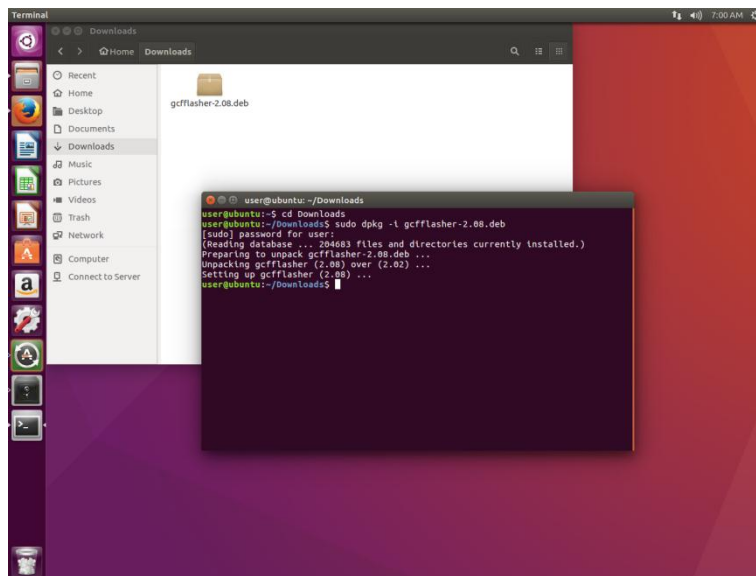

3. To upload the firmware, invoke GCFFlasher (superuser rights required) as follows:

```
$ sudo GCFFlasher -d <device> -f <YourApplication.bin[.GCF]>
```

For example:

```
$ sudo GCFFlasher -d 0 -f deCONZ_0x26050500.bin.GCF
```

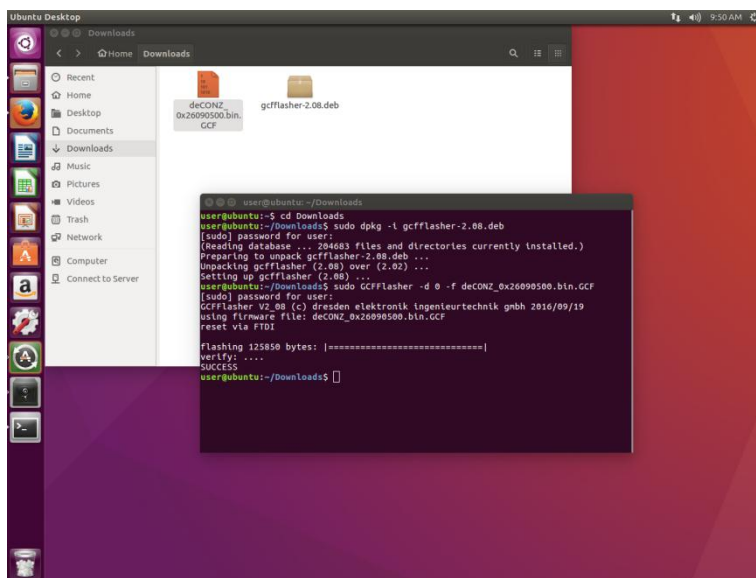

Note: You can list all devices with: `$ sudo GCFFlasher -l`

5.4. Notes on custom firmware

When using the JTAG interface, do not modify sensitive EEPROM areas like Bootloader control section, ZigBee firmware settings, NV-section containing i.e. MAC address, unless you are absolutely sure what you are doing. See **section 5.6** for details of sensitive EEPROM areas.

Please also note that dresden elektronik will neither provide firmware images of the bootloader nor support restoring the bootloader or EEPROM once overwritten.



5.5. Example with BitCatcher

BitCatcher is a software tool for analyzing wireless transmissions in ZigBee based networks and allows the monitoring of complex network structures as well as observe data flows and runtime performance in detail without additional effort.

Note: BitCatcher is only available in a legacy version and **will no longer be supported** by Luxoft. It is compatible only up to Windows 7.

5.5.1. Software

1. Download and install the Luxoft BitCatcher ZigBee Network Analyzer from:

<http://www.luxoft.com/embedded-systems-development/bitcatcher>

5.5.2. Firmware

1. Download the BitCatcher firmware for ConBee from:

<https://www.dresden-elektronik.de/funktechnik/service/downloads/software/>

2. Execute the steps of section 5.1, 5.2 and 5.3 depending on your operating system.

5.6. EEPROM layout

The radio module contained on the ConBee uses the following sensitive EEPROM sections. If developing custom firmware, please do not modify the sections already used.

Table 1: Sensitive EEPROM sections

EEPROM sections	
<i>address range</i>	<i>content / remark</i>
0x0000 ... 0x00FF	Bootloader specific
0x0100 ... 0x1EFF	user available
0x1F00 ... 0x1FDF	ZigBee firmware specific
0x1FE0 ... 0x1FFF	NV-section

5.7. Fuse settings

The table below shows the recommended fuse byte settings for the ConBee which the board also comes with in factory new condition. Please refer to the radio module user manual [4] for their description and alternative configurations.

Table 2: Fuse settings

Fuse bytes	Setting	Description
EXTENDED	0xF8	Extended fuse byte
HIGH	0x90	Fuse high byte
LOW	0xCE	Fuse low byte



6. Technical data

The USB Dongle contains the 2.4 GHz IEEE 802.15.4 radio module 'deRFmega256-23M12' by dresden elektronik. A detailed description of the module's characteristics and properties can be found in the radio module user manual [4].

Table 3: Mechanical data

Mechanical data						
<i>Value</i>	<i>Descriptor</i>	<i>Parameter</i>	<i>Min</i>	<i>Typ</i>	<i>Max</i>	<i>Unit</i>
Size	L			70.7		mm
	W			23.0		mm
	H			8.3		mm

Table 4: Temperature range

Temperature range						
<i>Value</i>	<i>Descriptor</i>	<i>Parameter</i>	<i>Min</i>	<i>Typ</i>	<i>Max</i>	<i>Unit</i>
Working temperature	T _{work}		-40	+25	+85	°C

Table 5: Absolute maximum ratings

Absolute maximum ratings						
<i>Value</i>	<i>Descriptor</i>	<i>Parameter</i>	<i>Min</i>	<i>Typ</i>	<i>Max</i>	<i>Unit</i>
Supply voltage	V _{in_max}	T=25°C			5.5	V
Supply current	I _{in_max}	TX_ON, TX_PWR=0x0			215	mA

Note: Stresses beyond those listed under “Absolute maximum ratings” may cause permanent damage to the device. This is a stress rating only and functional operation of the device at these or any other conditions beyond those indicated in the operational sections of this manual are not implied. Exposure to absolute maximum rating conditions for extended periods may affect device reliability. For more details about these parameters, refer to individual datasheets of the components used.

**Table 6: Electrical characteristics**

Electrical characteristics						
Value	Descriptor	Parameter	Min	Typ	Max	Unit
Supply voltage	V _{in}		4.5	5.0	5.5	V
Supply current	I _{in_trxoff}	V _{in} =5.0 V (only Bootloader)		5.5		mA
	I _{in_txon}	V _{in} =5.0 V, TX_PWR=0xE		59		mA
		V _{in} =5.0 V, TX_PWR=0xF		48		mA

Table 7: MCU clock

MCU clock						
Value	Descriptor	Parameter	Min	Typ	Max	Unit
MCU clock	CLK _{MCU}			8		MHz

Table 8: Radio characteristics

Radio characteristics						
Value	Descriptor	Parameter	Min	Typ	Max	Unit
Antenna	ANT1	Type	Chip Ceramic			
		Gain		-0.7		dBi
Coaxial connector	COAX	Type	U.FL			
Frequency range	F _{range_EU}	PHY_CC_CCA = 0x0B..0x1A	2405		2480	MHz
	F _{range_US}	PHY_CC_CCA = 0x0B..0x19	2405		2475	MHz
Channels	CH _{EU}	PHY_CC_CCA = 0x0B..0x1A	16			
	CH _{US}	PHY_CC_CCA = 0x0B..0x19	15			
Absolute TX power	POUT	V _{in} =5.0 V, TX_PWR=0xE			8.7	dBm
		V _{in} =5.0 V, TX_PWR=0xF			3.9	dBm



Receiver sensitivity	SENS	Data Rate = 250 kBit/s	-105	dBm
		Data Rate = 500 kBit/s	-101	dBm
		Data Rate = 1000 kBit/s	-99	dBm
		Data Rate = 2000 kBit/s	-94	dBm
Data rate (gross)	DR	TRX_CTRL_2 = 0x00	250	kbps
		TRX_CTRL_2 = 0x01	500	kbps
		TRX_CTRL_2 = 0x02	1000	kbps
		TRX_CTRL_2 = 0x03	2000	kbps

6.1. Output power and channel settings

The ConBee is able to provide an output power greater than 10 dBm. **Table 9** defines the power settings of the TX_PWR register [4], which must be set to fulfill all national requirements of Europe (EN 300 328) and the United States (CFR 47 Ch. I FCC Part 15).

Note: Channel 26 must be deactivated for using the USB Dongle in the United States to fulfill the band edge requirements of FCC Part 15 Subpart C § 15.247.

Table 9: Output power settings

Device	ConBee	
Region	ETSI (EU)	FCC (US)
Channel	TX_PWR	TX_PWR
11	0xF	0xE
12	0xF	0xE
13	0xF	0xE
14	0xF	0xE
15	0xF	0xE
16	0xF	0xE
17	0xF	0xE
18	0xF	0xE
19	0xF	0xE
20	0xF	0xE



21	0xF	0xE
22	0xF	0xE
23	0xF	0xE
24	0xF	0xE
25	0xF	0xF
26	0xF	Not used

7. Pin assignment

This section lists all available signals and their function on the USB Dongle.

Note: The signal NC means Not Connected. NA means Not Assembled.

Table 10: Signal pin description

Signal pin description of assembled radio module deRFmega256-23M12			
<i>Radio module pin</i>	<i>Signal</i>	<i>Function</i>	<i>Comment</i>
28	PE0/RXD0	UART RX 0	Communication interface to FTDI
29	PE1/TXD0	UART TX 0	Communication interface to FTDI
30	PE2/XCK0	CTS	Communication interface to FTDI
4	RESET	Reset	10k pull-up onboard, low-active, Connected to CBUS0 of FTDI
27	PB7	SW1	Button to GND (NA)
15	PD7	LED1	Red, low-active (NA)
8	PG2	LED2	Green, low-active (NA)
57	RFOUT1	RF out signal 1	terminated with 49R9 resistor
53	RFOUT2	RF out signal 2	Chip antenna
48	PF4/TCK	JTAG	NA
47	PF5/TMS	JTAG	NA
46	PF6/TDO	JTAG	NA
45	PF7/TDI	JTAG	NA



13	PD2/RXD1	UART RX 1	NA
12	PD3/TXD1	UART TX 1	NA
20	PB0/SS	Chip Select	Serial Flash Memory (NA)
21	PB2/MOSI	Serial Data In	Serial Flash Memory (NA)
22	PB1/SCK	Serial Clock	Serial Flash Memory (NA)
23	PB3/MISO	Serial Data Out	Serial Flash Memory (NA)
-	VBUS	Voltage supply	5 V supplied by USB port
2, 50	VCC	Voltage supply	3.3 V generated internally
1, 31, 44, 49, 51	GND	Ground	System ground

Table 11: Header pin description

Header pin description			
<i>Header</i>	<i>Pin</i>	<i>Signal</i>	<i>Comment</i>
Program (not assembled)	1	TCK	JTAG
	2	GND	
	3	TDO	JTAG
	4	VCC	3.3 V generated internally
	5	TMS	JTAG
	6	RESET	Reset signal for ZigBee USB Gateway
	7	VCC	3.3 V generated internally
	8	NC	
	9	TDI	JTAG
	10	GND	
Trace (not assembled)	1	TXD1	UART
	2	VCC	3.3 V generated internally



	3	NC	
	4	RXD1	UART
	5	NC	
	6	GND	

8. Hardware modifications for development

Besides the factory-default USB Dongle configuration it is also possible to modify the hardware to enhance its functionality.

8.1. Assemble the program header

The program header provides the microcontroller programming interface of the radio module. Assemble a 50 mil 10-pin SMT header on the bottom side. We recommend the use of the header FTSH-105-04-LM-DV-P by SAMTEC or a similar item.

The header pin description can be found in **Section 8 Table 11** . A detailed description of suitable programmers and related software tools are listed in **[5]**.

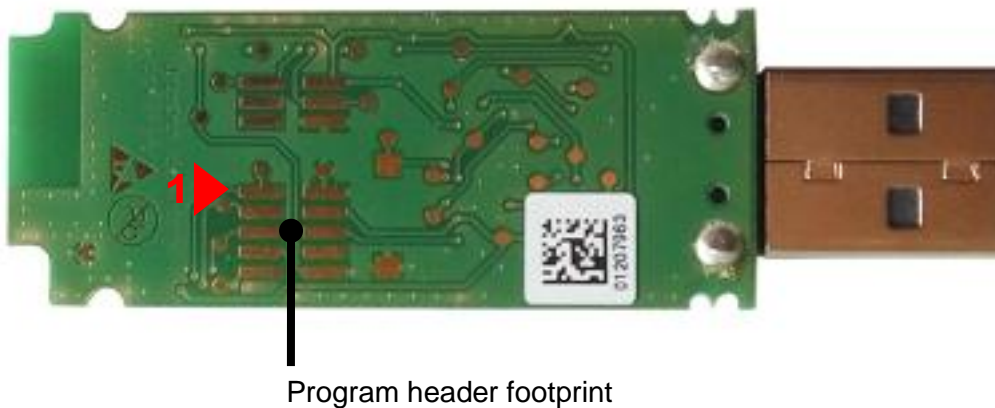

Figure 3: USB Dongle program header position (default not assembled)

Note: Improper handling in respect of erasing or overwriting the MCU internal flash or EEPROM completely or in parts may result in an unusable USB Dongle unit. Modification of the pre-allocated EEPROM memory sections or removal of the pre-installed bootloader will irreversibly preclude restoring, booting or upgrading the shipping firmware at all. dresden elektronik will not support such modifications (see **Section 5.3** for details).

8.2. Assemble the trace header

The trace header provides the microcontroller UART interface of the radio module. Assemble a 50 mil 6-pin SMT header on the bottom side. We recommend the use of the header FTSH-103-01-F-DV by SAMTEC or a similar item.

The header pin description can be found in **Section 8 Table 11**.



Figure 4: USB Dongle trace header position (default not assembled)

8.3. Assemble the Serial Flash Memory

The USB Dongle offers the use of an external Serial Flash Memory for custom application or features. The memory interface is connected to the SPI of the radio module. The provided footprint is SO-8. We recommend the use of a Serial Flash Memory like M25P40-VMN6TPB by MICRON. It is useful to place a stabilizing capacitor of 100nF to the 0402 footprint next to the memory.

The signal pin description can be found in **Section 8 Table 10**.

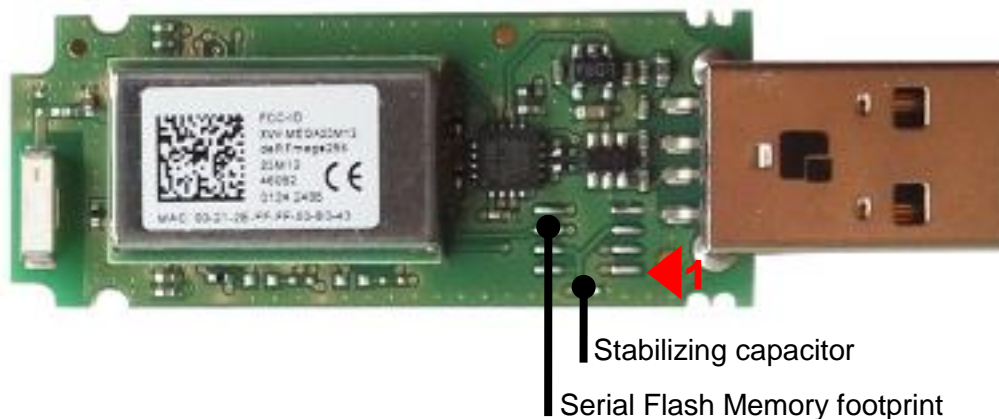

Figure 5: USB Dongle Serial Flash Memory position (default not assembled)

8.4. Assemble the User button

The USB Dongle offers the use of an external user button. We recommend the use of the SMT button KSR211GLFS by ITT or similar items. The button is connected with ground and signal PB7.

The signal pin description can be found in **Section 8 Table 10** **Table 11**.

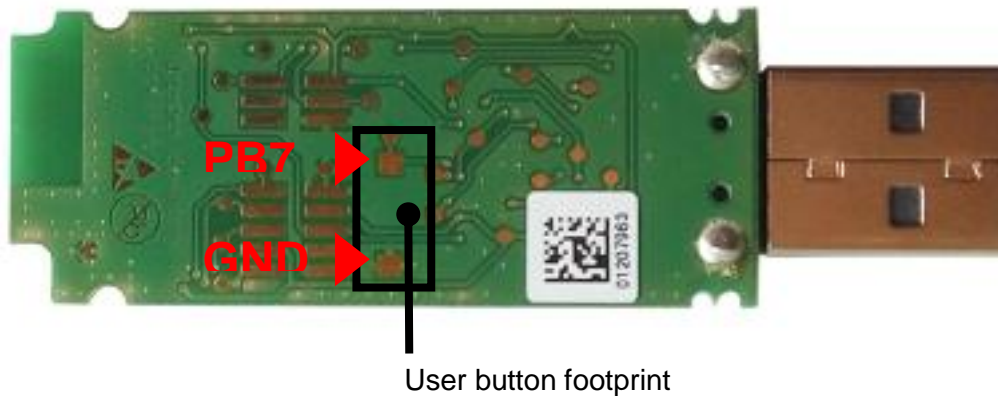

Figure 6: USB Dongle user button position (default not assembled)

8.5. Assemble the status LEDs

The USB Dongle offers the use of two status LEDs. The first LED is connected with signal PD7 and the second LED is connected with signal PG2. Each LED needs one additional series resistor with a value of 820 Ohms. Both LEDs are low-active. We recommend the use of the following LEDs and resistors:

- Red low current LED: TLMS1000-GS08 by Vishay (SMT package 0603)
- Green low current LED: LG L29K-G2J1-24-Z by OSRAM (SMT package 0603)
- Resistor 820 Ohms: RC0402FR-07820RL by YAGEO (SMT package 0402)

The signal pin description can be found in **Section 8 Table 10**.

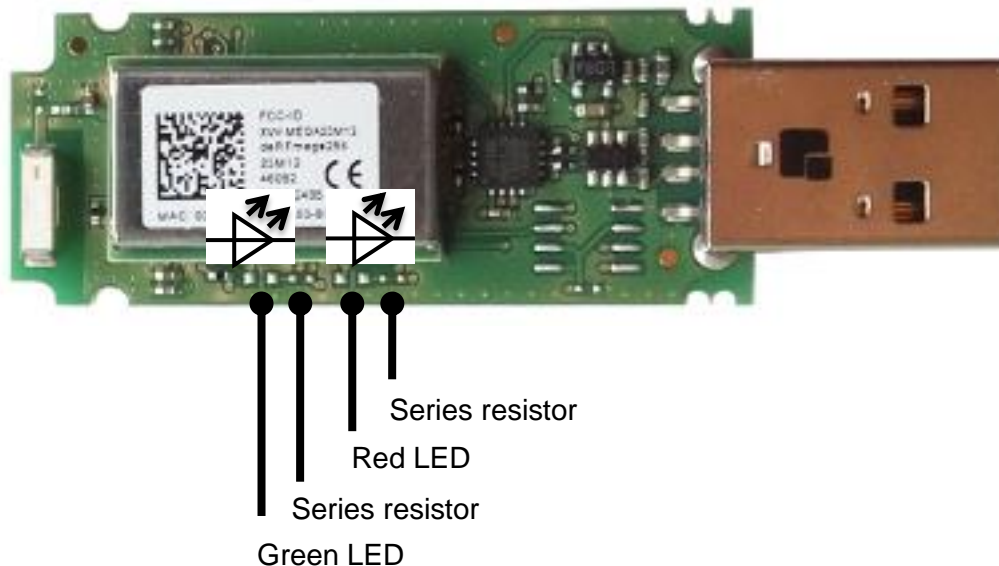

Figure 7: USB Dongle status LEDs (default not assembled)



9. Radio certification

9.1. United States (FCC)

The ConBee contains the radio module 'deRFmega256-23M12', which is certified according to FCC part 15. The FCC-ID of the radio module deRFmega256-23M12 is printed on a visible permanently affixed label on the top of the module's RF shielding.

This product contains FCC ID: XVV-MEGA23M12

This equipment complies with Part 15 of the FCC Rules. Operation is subject to the following two conditions: (1) this device may not cause harmful interference, and (2) this device must accept any interference received, including interference that may cause undesired operation (FCC 15.19). The internal / external antenna(s) used for this mobile transmitter must provide a separation distance of at least 20 cm from all persons and must not be co-located or operating in conjunction with any other antenna or transmitter.

Modifications not expressly approved by the manufacturer could void the user's authority to operate this equipment (FCC section 15.21).

This equipment has been tested and found to comply with the limits for a Class A digital device, pursuant to Part 15 of the FCC Rules. These limits are designed to provide reasonable protection against harmful interference when the equipment is operated in a commercial environment. This equipment generates, uses, and can radiate radio frequency energy and, if not installed and used in accordance with the instruction manual, may cause harmful interference to radio communications. Operation of this equipment in a residential area is likely to cause harmful interference in which case the user will be required to correct the interference at their own expense (FCC section 15.105).

This equipment has been tested and found to comply with the limits for a Class B digital device, pursuant to Part 15 of the FCC Rules. These limits are designed to provide reasonable protection against harmful interference in a residential installation. This equipment generates, uses and can radiate radio frequency energy and, if not installed and used in accordance with the instructions, may cause harmful interference to radio communications. However, there is no guarantee that interference will not occur in a particular installation. If this equipment does cause harmful interference to radio or television reception, which can be determined by turning the equipment off and on, the user is encouraged to try to correct the interference by one or more of the following measures:

- Reorient or relocate the receiving antenna
- Increase the separation between the equipment and receiver
- Connect the equipment into an outlet on a circuit different from that to which the receiver is connected
- Consult the dealer or an experienced radio/TV technician for help

9.2. European Union (ETSI)

The ConBee is compliant for use in European Union countries.

Hereby, dresden elektronik ingenieurtechnik gmbh declares that the radio equipment type ConBee is in compliance with Directive 2014/53/EU. The full text of the EU declaration of conformity is available at the following internet address: www.dresden-elektronik.de



If the USB Dongle is incorporated into a product, the manufacturer must ensure compliance of the final product to the European harmonized EMC and low-voltage/safety standards. A Declaration of Conformity must be issued for each of these standards and kept on file as described in Annex II of the R&TTE Directive.

The manufacturer must maintain a copy of the USB Dongle documentation and ensure the final product does not exceed the specified power ratings, antenna specifications, and/or installation requirements as specified in the user manual. If any of these specifications are exceeded in the final product, a submission must be made to a notified body for compliance testing to all required standards.

9.3. Approved antenna list

The USB Dongle has an integrated chip antenna. The design is fully compliant with all regulations and certified as reference design of the integrated radio module deRFmega256-23M12 (FCC ID: XVV-MEGA23M12).

Table 12: Approved antenna

Approved antenna(s) for deRFmega256-23M12				
Type	Gain	Mount	Order code	Vendor / Supplier
<i>Integrated antenna</i>				
2400 to 2483.5 MHz Chip antenna	+1.3dBi (peak)	SMT	2450AT43B100	Johanson Technology

10. Ordering information

Table 13: Ordering information

Ordering information		
Part Number	Product Name	Comment
BN-600090	ConBee	Contains bootloader application

11. Revision notes

Actually no design issues are known.



12. References

- [1] ZigBee Light Link,
URL: <http://www.zigbee.org/zigbee-for-developers/applicationstandards/zigbee-light-link/>
- [2] User Manual deCONZ;
URL: <https://www.dresden-elektronik.de/funktechnik/service/download/documentation/>
- [3] Quick Start Guide Wireless Light Control,
URL: <https://www.dresden-elektronik.de/funktechnik/service/downloads/documentation/>
- [4] User Manual deRFmega256 radio modules;
URL: <https://www.dresden-elektronik.de/funktechnik/service/downloads/documentation/>
- [5] Software Programming User Manual;
URL: <https://www.dresden-elektronik.de/funktechnik/service/downloads/documentation/>



dresden elektronik ingenieurtechnik gmbh
Enno-Heidebroek-Straße 12
01237 Dresden
GERMANY

Phone +49 351 31850-0
Fax +49 351 31850-10
Email wireless@dresden-elektronik.de

Trademarks and acknowledgements

- IEEE 802.15.4™ is a trademark of the Institute of Electrical and Electronics Engineers (IEEE).
- ZigBee® is a registered trademark of the ZigBee Alliance.
- ZigBee USB Gateway™ is a registered trademark of the dresden elektronik ingenieurtechnik gmbh.

All trademarks are registered by their respective owners in certain countries only. Other brands and their products are trademarks or registered trademarks of their respective holders and should be noted as such.

Disclaimer

This note is provided as-is and is subject to change without notice. Except to the extent prohibited by law, dresden elektronik ingenieurtechnik gmbh makes no express or implied warranty of any kind with regard to this guide, and specifically disclaims the implied warranties and conditions of merchantability and fitness for a particular purpose. dresden elektronik ingenieurtechnik gmbh shall not be liable for any errors or incidental or consequential damage in connection with the furnishing, performance or use of this guide.

No part of this publication may be reproduced, stored in a retrieval system, or transmitted in any form or any means electronic or mechanical, including photocopying and recording, for any purpose other than the purchaser's personal use, without the written permission of dresden elektronik ingenieurtechnik gmbh.

Copyright © 2016 dresden elektronik ingenieurtechnik gmbh. All rights reserved.