

K8 Series

2.5" SATA Solid State Drive Engineering Specification

LITE-ON CONFIDENTIAL

Document History

Revision	Date	Changes
Rev 1.0	2017/01/20	First release

LITE-ON CONFIDENTIAL

Table of Contents

1	Introduction.....	5
2	Features	5
3	Block Diagram	6
4	Basic Specifications	7
4.1	Capacity.....	7
4.2	Flash Type	7
4.3	Program/Erase Cycle	7
4.4	ECC Ability	7
4.5	Buffer Memory Size	7
4.6	Compatibility	8
4.7	Band Performance	8
4.8	Read and Write IOPS (IOMETER)	8
4.9	Power On to Ready	9
4.10	Temperature	9
4.11	Reliability	10
4.12	Shock and Vibration	10
4.13	Altitude	11
4.14	Angle	11
4.15	Rattle Noise	11
4.16	Operating noise	11
4.17	Electromagnetic Compatibility.....	11
4.18	Compliance.....	12
5	Power Supply	13
5.1	Power Interface.....	13
5.2	Current Consumption	13
5.3	Power ON Reset.....	13
5.4	Power Off Sequence	14
5.5	Power Mode	15
6	Outline and Dimension	16
7	Pin Locations and Definition.....	17
7.1	Pin Location.....	17
7.2	Signal Description	17
8	Handling Recommendation	19
9	Command Description.....	20
9.1	ATA Command	20
9.2	Vendor Specify Command	23
9.3	Identify Device Data	24

References..... 28
Terms and Acronyms..... 29

LITE-ON CONFIDENTIAL

1 Introduction

The **K8 series** 2.5" SATA Solid State Drive (SSD) delivers leading performance in an industry standard 2.5" form factor while simultaneously improving system responsiveness for automotive applications over standard rotating drive media or hard disk drives. By combining leading NAND flash memory technology with our innovative high performance firmware, LITEON Tech delivers SATA SSD drives drop-in replacement with enhanced performance, reliability, ruggedness and power savings. Since there are no rotating platters, moving heads, fragile actuators, or unnecessary delays due to spin-up time or positional seek time that can slow down the storage subsystem, significant I/O and throughput performance improvement is achieved as compared to rotating media or hard disk drives. They are 100% fully compatible with 2.5inch HDD but with best ability against the vibration and shock in vehicle environment. This document describes the specifications of the **K8 series** 2.5" SATA SSD in 2.5" form factors.

The **K8 series** 2.5" SATA SSD key attributes include high performance, low power, increased system responsiveness, high reliability, and enhanced ruggedness as compared to standard automotive SATA hard drives. The **K8 series** 2.5" SATA SSD is available in a 2.5" form factor that is electrically, mechanically, and software compatible with existing 2.5" SATA slots and cables. Our flexible design allows interchangeability with existing mobile hard drives based on the SATA interface standard.

2 Features

- **High transfer rate mass storage device**
- **S-ATA III 6.0G interface**
- **No movement parts and noise free**
- **Excellent ability against Shock/Vibration**
- **Fast access performance**
- **Form Factor: 2.5" SSD**
- **Inbuilt Surge Protection against Overvoltage**

3 Block Diagram

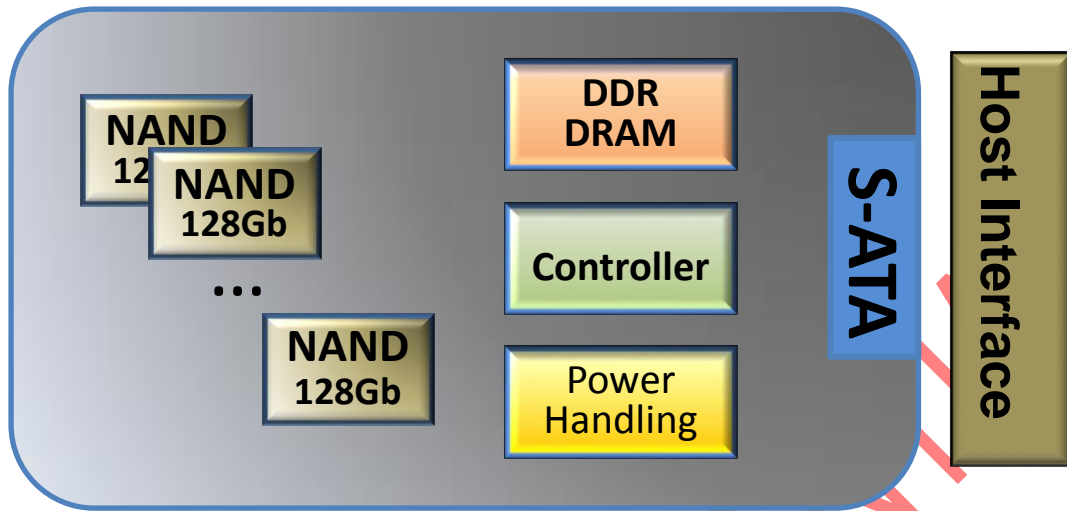

Figure 1 Block Diagram

4 Basic Specifications

4.1 Capacity

4.1.1 Physical Capacity

128GB: K8-L1128

256GB: K8-L1256

512GB: K8-L1512

1024GB: K8-L11T0

4.1.2 User Capacity

Unformatted capacity	Total user addressable sectors in LBA mode
128GB	250,069,680
256GB	500,118,192
512GB	1,000,215,216
1024GB	2,000,409,264

Table 1 User Addressable Sectors

Notes: 1. 1GB=1,000,000,000 bytes and not all of the memory can be used for storage.

2. 1 Sector = 512 bytes

4.2 Flash Type

Multi-Level Cell (MLC)

4.3 Program/Erase Cycle

3000(global)

4.4 ECC Ability

81bits/2KB

4.5 Buffer Memory Size

128MB-1GB DDR3, consist of FTL Table and write cache data.

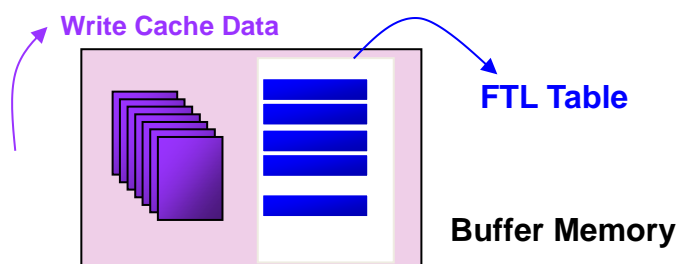

4.6 Compatibility

- SATA Revision 3.0 compliant
- Compatible with SATA 1.5Gb/s, 3.0Gb/s & 6.0Gb/s Interface rates
- ATA/ATAPI- 8 compliant
- SSD enhanced SMART ATA feature set
- Native Command Queuing (NCQ) command set
- TRIM supported

4.7 Band Performance

Test Condition: 25°C under SATA 6.0G

Capacity	Access Type	MB/s
128GB	Sequential Read	Up to 500 MB/s
	Sequential Write	Up to 160 MB/s
256GB	Sequential Read	Up to 500 MB/s
	Sequential Write	Up to 300 MB/s
512GB	Sequential Read	Up to 500 MB/s
	Sequential Write	Up to 400 MB/s
1024GB	Sequential Read	Up to 500 MB/s
	Sequential Write	Up to 450 MB/s

Table 2 Maximum Sustained Read and Write Bandwidth

- Notes:** 1). Performance measured using CrystalDiskMark.
 2). 1 MB/sec = 1,048,576 bytes/sec is used in measuring sequential performance.
 If 1 MB/sec = 1,000,000 bytes/sec is used, performance values become 4.85% higher.

4.8 Read and Write IOPS (IOMETER)

Test Condition: 25°C

Capacity	Access Type	IOPS
----------	-------------	------

128GB	4K Read (IOPS)	70,000
	4K Write (IOPS)	40,000
256GB	4K Read (IOPS)	70,000
	4K Write (IOPS)	70,000
512GB	4K Read (IOPS)	80,000
	4K Write (IOPS)	80,000
1024GB	4K Read (IOPS)	80,000
	4K Write (IOPS)	80,000

Table 3 Random Read/Write Input/output Operations per Second

- Notes:** 1. Performance measured using IOMETER.
 2. Write cache enabled

4.9 Power On to Ready

Operating Mode	Typical (25°C)	Max.(-40°C to +85°C)
Power on to Ready	1s	4s

Table 4 Latency Specifications

- Notes:** 1. Write cache enabled
 2. Device measured using Drive Master
 3. Power on to ready time assumes proper shutdown
 (Power removal preceded by Flush Cache or STANDBY command)

4.10 Temperature

Environment	Mode	Min	Max	Unit
Ambient Temperature	Operating	0	70	°C
	Non-operating, Storage	-40	85	°C
Humidity	Operation	5	95	%
	Non-operation, Storage	5	95	%

Table 5 Temperature Relative Specifications

No permanent damage will occur on the module when it is powered ON at -40°C and +95°C. There will be no flame / spark / smoke from the module in any condition of short circuit and/or temperature above +95°C.

4.11 Reliability

Parameter	Value
Mean Time between Failure (MTBF)	2,500,000 hours
Power on/off cycles	25,000 cycles
Data Reliability	1 per 10 ¹³ bits read (max)
Interface	50 cycles of Insert and Removal operation(min)

Table 6 Reliability specifications

Notes:

1. MTBF is calculated based on a Part Stress Analysis under 35° C. It assumes nominal voltage. With all other parameters within specified range.
2. Power on/off cycles is defined as power being removed from the drive, and the restored. Application systems remove power with the Flush Cache command or Standby Immediate command in advance before the system shutdown.

4.12 Shock and Vibration

Item	Mode	Timing/Frequency	Max
Shock ¹	Operation Non-operating	At 1 msec half-sine	1500G
	Operation Non-operating	At 2 msec half-sine	1000G
Random Vibration ²	Operation	7~800 Hz	2.17Grms
	Non-operation	7~800 Hz	3.08Grms

Table 7 Shock and Vibration

Notes:

1. Shock specifications assume that the SSD is mounted securely with the input vibration applied to the drive mounting screws. Stimulus may be applied in the X, Y or Z axis
2. Vibration specifications assume that the SSD is mounted securely with the input vibration applied to the drive mounting screws. Stimulus may be applied in the X, Y or Z axis. The measured specification is in root mean squared form.

4.13 Altitude

Operational Altitude: 5,500 meters
 Altitude Gradient: 300m / min

4.14 Angle

The drives will operate at any Angle or/and Orientation.

4.15 Rattle Noise

The drives will have no rattle noise during any operation.

Note: There are no movement parts in the SSD drives; the rattle noise will not be tested.

4.16 Operating noise

The operating noise of the module will not exceed 35dBA (20Hz to 20kHz)

Note: There are no movement parts in the SSD drive; the operation noise will not be tested.

4.17 Electromagnetic Compatibility

Electromagnetic compatibility tests assume the SSD is properly installed in the representative host system. The drive operates properly without errors degradation in performance when subjected to radio frequency (RF) environments defined in the following table.

Test	Description	Performance criteria	Reference standard
Electrostatic discharge	Packaging and Handling Contact $\pm 4KV$ $\pm 8KV$	A	IEC 61000-4-2:2008
Electrostatic discharge	Production and Service Contact $\pm 2KV$	A	IEC 61000-4-2:2008
Radiated Emission	-	-	CISPER-22 Class B

Table 8 Radio Frequency Specifications

Notes:

1. Performance criterion A = The device shall continue to operate as intended, i.e., normal unit operation with no degradation of performance.
2. Performance criterion B = The device shall continue to operate as intended after completion of test, however, during the test, some degradation of performance is allowed as long as there is no data loss operator intervention to restore device function.
3. Performance criterion C = Temporary loss of function is allowed. Operator intervention is acceptable to restore device function.

4. Contact electrostatic discharge is applied to drive enclosure during operation.
5. Contact electrostatic discharge is applied to drive enclosure and I/O pins when Non-Operation.

4.18 Compliance:

Certification	Description
RoHS compliant	Restriction of Hazardous Substance Directive
CE compliant	Indicates conformity with the essential health and safety requirements set out in European Directives Low voltage Directive and EMC Directive
UL certified	Underwriters Laboratories, Inc. Component Recognition UL60950-1
BSMI	Compliance to the Taiwan EMC standard "Limits and methods of Radio Disturbance Characteristics of Information Technology Equipment, CNS 13438 Class B"

Table 9 Device Compliance

5 Power Supply

5.1 Power Interface

Description	Specifications
Nominal Supply (V1)	+5Vdc +/- 5%
Absolute Voltage	Min. -0.5V Max. +10V
Ripple voltage (0-20MHz)	150mV p-p max
Supply Rise Time	1 – 100ms

Table 10 Operating Voltage

5.2 Current Consumption

K8-L1096/K8-L1128/K8-L1256/K8-L1512/K8-L11T0:

Operation Mode	Typical	Max.	Unit
Idle Mode	0.07	0.1	A
Read Mode	0.35	0.9	A
Write Mode	0.4	0.9	A
Power On Inrush Current (T<10ms)	-	1.5	A

Table 11 Current Consumption

Note: Active power is measured using IOMETER Power Consumption with RMS current 5s.

Active Mode: Measured after power on initiation and without activity.

5.3 Power ON Reset

Parameter	Symbol	Min.	Typ.	Max	Unit
Detect voltage Rising	V _{DET,R}	3.46	-	3.95	V
Detect voltage Falling	V _{DET,F}	3.4	-	3.8	V
Input voltage high	V _{IH}	2.0	-	-	V
Delay time	t _{delay}	5	-	40	ms

Table 12 Power On Reset Characteristics

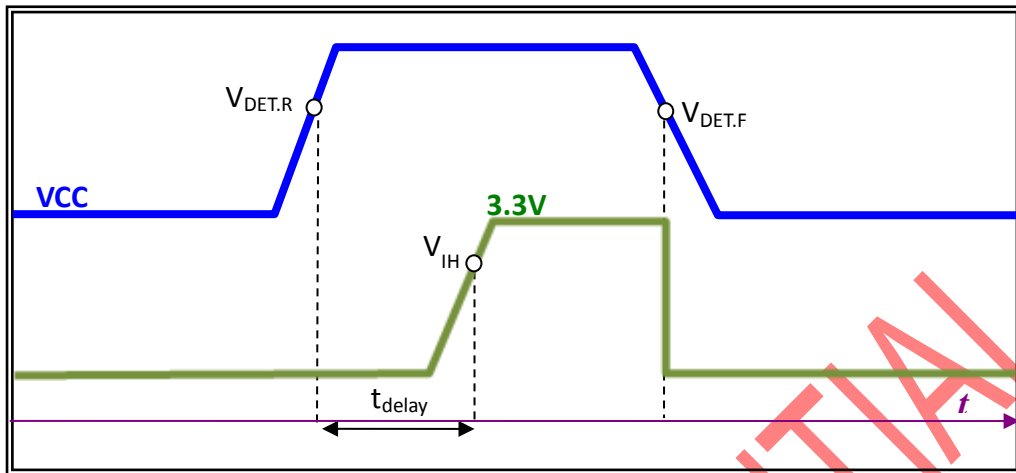

Figure 2 Power On Reset

5.4 Power Off Sequence

Note: Power off without Flush Cache command or Standby Immediate Command in advance may cause cache buffer data which received from host and waiting for programming lose. Please implement the power off sequence as the process in the Figure 3 to prevent the data loss

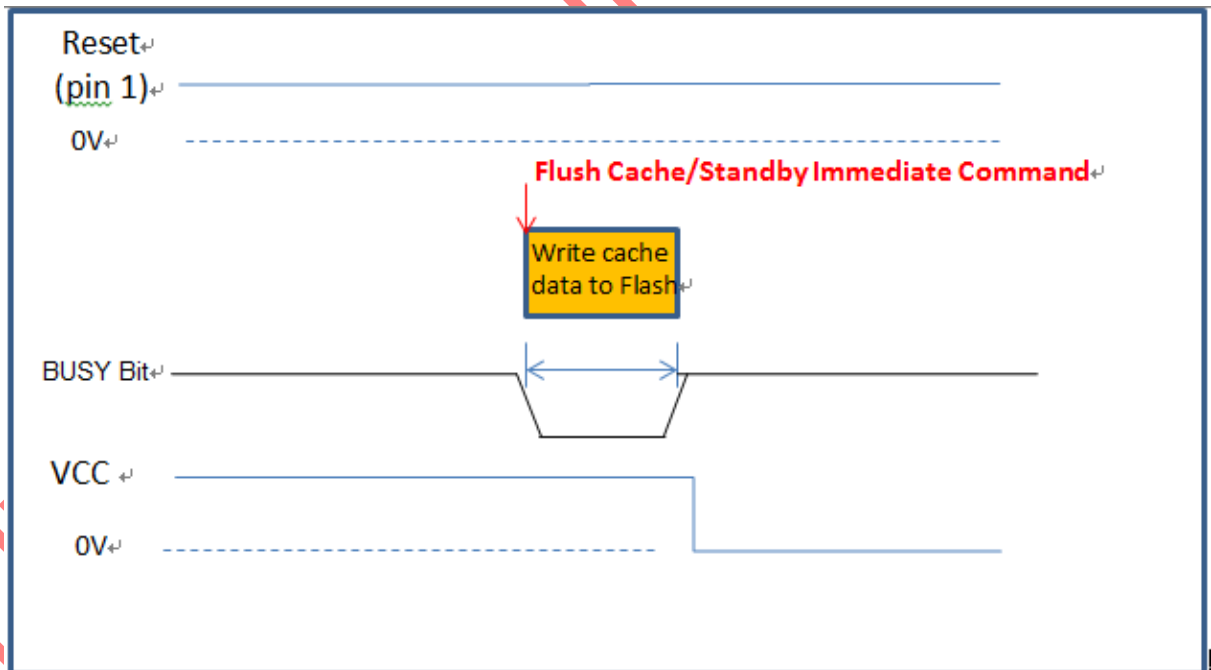

Figure 3 Power off sequence

5.5 Power Mode

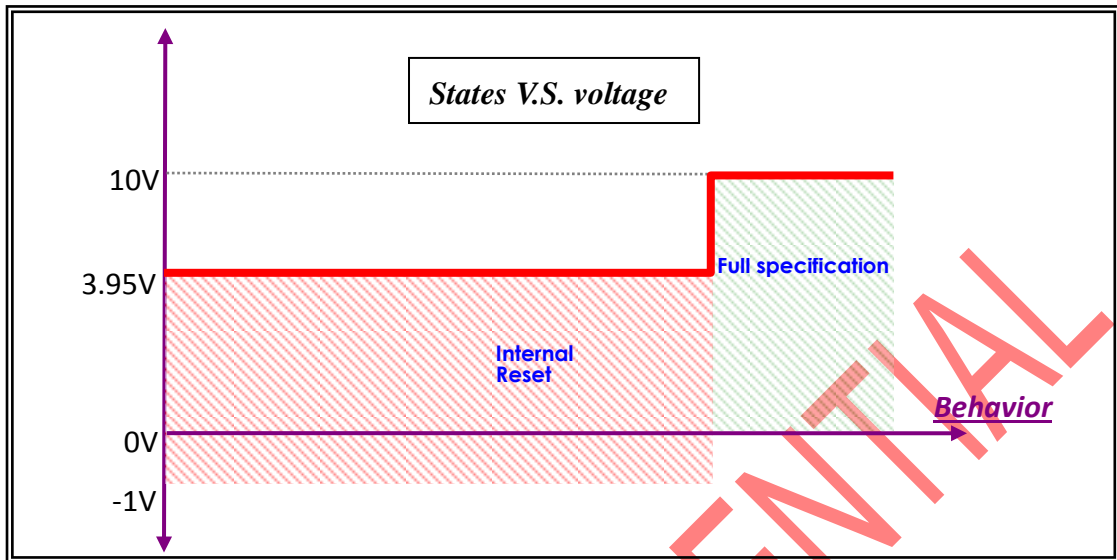

Figure 4 Power Mode

The module has a reset controlled protection implemented.

Table 13 DC Characteristics

6 Outline and Dimension

6.1 The module is compliance to SFF-8201

6.2 Dimension

100.0mm x 69.85mm x 6.8 mm (L x W x H)

6.3 Weight:

7mm:60 g Max(with case)

6.4 The module is capable of taking maximum tightening screw torque of 0.4 Nm

6.5 The module is fully functional when subject to Flatness or Co-planarity of 0.5 mm

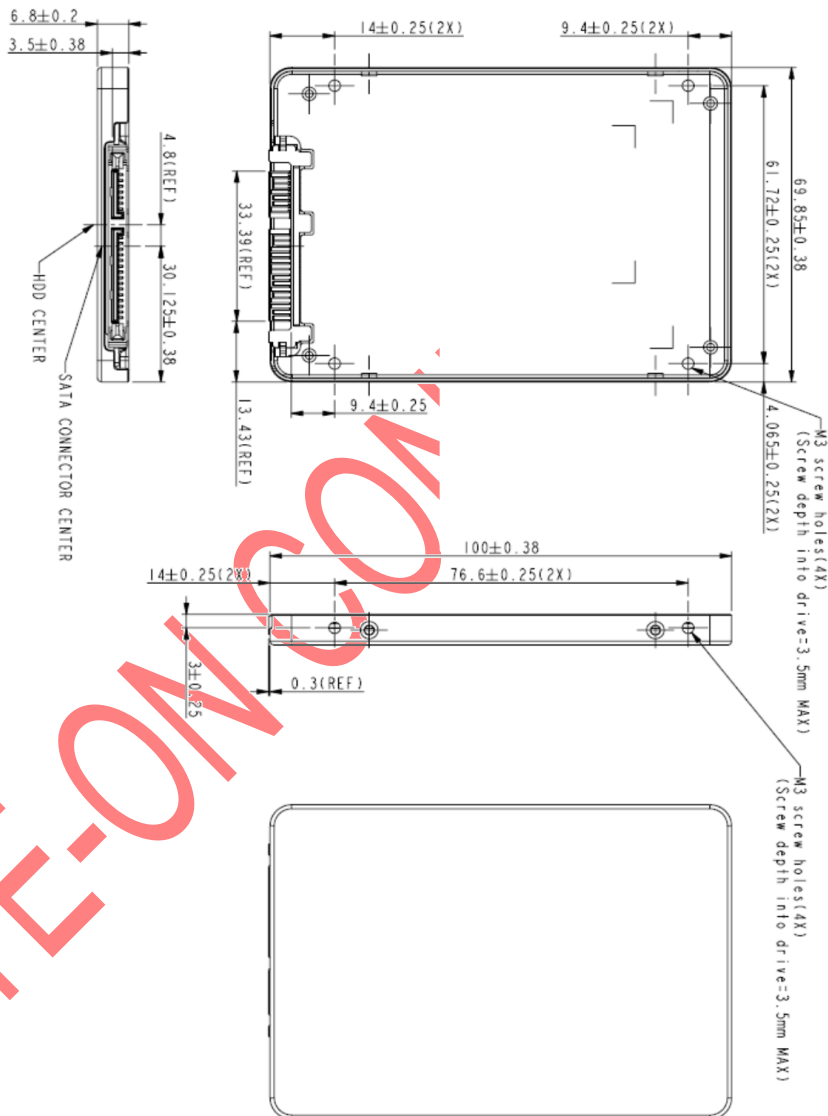

7 Pin Locations and Definition

7.1 Pin Location

The data and power connector pin locations of the K8 series 2.5" SATA 6 Gb/s SSD are as shown below.

7.2 Signal Description

Data Connector:

1	Type	Description
S1	GND	
S2	A+	Differential Signal Pair A
S3	A-	
S4	GND	
S5	B-	Differential Signal Pair B
S6	B+	
S7	GND	

Power Connector:

Name	Type	Description
P1	V ₃₃	3.3V Power (No Use)
P2	V ₃₃	3.3V Power (No Use)
P3	V ₃₃	3.3V Power, Pre-change (No Use)
P4	GND	
P5	GND	
P6	GND	
P7	V ₅	5V Power, Pre-change
P8	V ₅	5V Power
P9	V ₅	5V Power
P10	GND	
P11	DAS	Device Activity Signal
P12	GND	
P13	V ₁₂	12V Power, Pre-change(No Use)
P14	V ₁₂	12V Power(No Use)
P15	V ₁₂	12V Power(No Use)

Table 14 Pin Name

Note:

1. All pins are in a single row, with a 1.27mm (0.05") pitch
2. Pins P1, P2 and P3 are connected together, although they are not connected internally to the

device. The host may put 3.3v on these pins.

3. The mating sequence is
 - The ground pins P4-P6, P10, P12 and the 5V power pin P7
 - The signal pins and the rest of the 5V power pins P8-P9
4. Ground connectors P4 and P12 may contact before the other 1st mate pins in both the power and signal connectors to discharge ESD in a suitably configured backplane connector.
5. Power pins P7, P8 and P9 are internally connected to one another within the device.
6. The host may ground P11 if it is not used for Device Activity Signal (DAS)
7. Pins P13, P14, P15 are connected together, although they are not connected internally to the device.

LITE-ON CONFIDENTIAL

8 Handling Recommendation

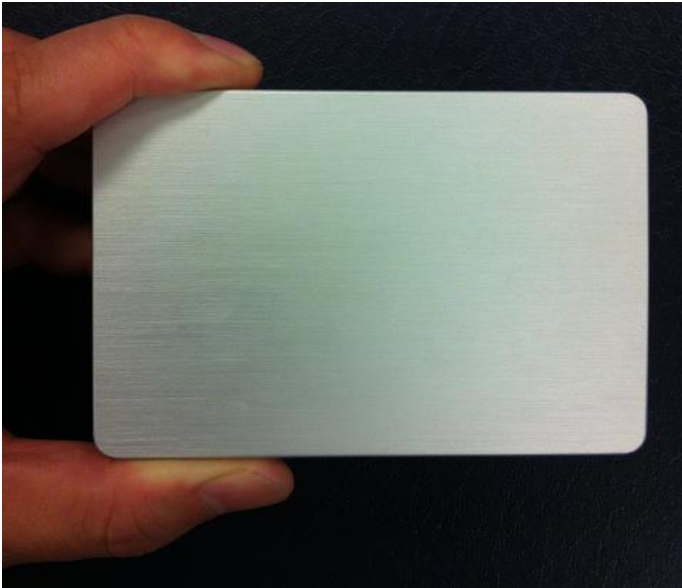

1. The recommended ways to hold the SSD are shown as pictures on the left
2. When handling, keep fingers away from the **S-ATA** connector at all times, as static electricity can damage the electronics inside.
3. Never stack SSDs
4. Please be gentle when inserting the SSD

9 Command Description

9.1 ATA Command

The **K8 series** 2.5" SATA SSD supports all the mandatory ATA commands defined in the ATA/ATAPI-8 specification.

ATA General Feature Command Set

General feature Command set (non-packet)

- EXECUTE DEVICE DIAGNOSTIC
- FLUSH CACHE
- IDENTIFY DEVICE
- READ DMA
- READ SECTOR(S)
- READ VERIFY SECTORS(S)
- SEEK
- SET FEATURES
- TRIM (*ATA/ATAPI-8 specification)
- WRITE DMA
- WRITE SECTOR(S)
- READ MULTIPLE
- SET MULTIPLE MODE
- WRITE MULTIPLE

Optional commands

- READ BUFFER
- WRITE BUFFER
- NOP
- DOWNLOAD MICROCODE

Power Management Command Set

- CHECK POWER MODE
- IDLE
- IDLE IMMEDIATE
- SLEEP
- STANDBY
- STANDBY IMMEDIATE

Security Mode Feature Set

- SECURITY SET PASSWORD
- SECURITY UNLOCK
- SECURITY ERASE PREPARE
- SECURITY ERASE UNIT
- SECURITY FREEZE LOCK
- SECURITY DISABLE PASSWORD

Host Protected Area Command Set

- READ NATIVE MAX ADDRESS
- SET MAX ADDRESS
- READ NATIVE MAX ADDRESS EXT
- SET MAX ADDRESS EXT

Optional commands.

- SET MAX SET PASSWORD
- SET MAX LOCK
- SET MAX FREEZE LOCK
- SET MAX UNLOCK

48-Bit Address Command Set

- READ NATIVE MAX ADDRESS
- FLUSH CACHE EXT
- READ DMA EXT
- READ NATIVE MAX ADDRESS EXT
- READ SECTOR(S) EXT
- READ VERIFY SECTOR(S) EXT
- SET MAX ADDRESS EXT
- WRITE DMA EXT
- WRITE MULTIPLE EXT
- WRITE SECTOR(S) EXT

SMART Command Set

- SMART ENABLE OPERATIONS
- SMART DISABLE OPERATIONS
- SMART ENABLE/DISABLE AUTOSAVE
- SMART RETURN STATUS

Optional commands.

- SMART EXECUTE OFF-LINE IMMEDIATE
- SMART READ DATA
- SMART READ LOG
- SMART WRITE LOG

The table below lists the SMART commands.

Subcommand	Code	LBA Low value
SMART ATTRIBUTE VALUES (READ DATA)	D0h	
READ ATTRIBUTE THRESHOLDS	D1h	
ENABLE/DISABLE ATTRIBUTE AUTOSAVE	D2h	
SAVE ATTRIBUTE VALUES	D3h	
EXECUTE OFF-LINE IMMEDIATE	D4h	
EXECUTE SMART OFF-LINE ROUTINE		00h
EXECUTE SMART SHORT SELF-TEST ROUTINE (OFFLINE)		01h
EXECUTE SMART EXTENDED SELF-TEST ROUTINE (OFFLINE)		02h
ABORT OFF-LINE ROUTINE		7Fh
EXECUTE SMART SHORT SELF-TEST ROUTINE (CAPTIVE)		81h
EXECUTE SMART EXTENDED SELF-TEST ROUTINE (CAPTIVE)		82h
READ LOG SECTOR	D5h	
WRITE LOG SECTOR	D6h	
ENABLE SMART OPERATIONS	D8h	
DISABLE SMART OPERATIONS	D9h	
RETURN SMART STATUS	DAh	
Enable/Disable Automatic OFFLINE	DBh	

SMART Attributes

- 01h : Raw Read Error Rate
- 05h : Re-allocated Sector Count
- 09h : Power-On Hours Count
- 0Ch : Power Cycle Count
- ADh : Average Program/Erase Count
- B1h : Wear Leveling Count
- B2h : Used Reserved Block Count (Worst Case)
- B5h : Program Fail Count (Total)
- B6h : Erase Fail Count (Total)
- BBh : Uncorrectable Error Count
- C0h : Unsafe Shutdown Count
- C2h : Temperature
- C4h : Reallocate Event Count
- C6h : Offline Uncorrected Error Count
- C7h : CRC Error Count
- E8h : Available reserved space
- F1h : Total data host wrote
- F2h : Total data host read
- F4h : Maximum Program/Erase Count
- F5h : Minimum Program/Erase Count

9.2 Vendor Specify Command: Get Temperature Command (Optional)

9.2.1 OP Code : 0xFA

See the following table for the byte definitions of Return Data:

Byte	Value	Description
0	Temperature	This byte indicates the current temperature in degrees Celsius. Valid values are D8h to 7Dh (-40 to +125).
1-511	00h	Reserved

9.2.2 SMART Attribute C2h

Attribute ID: C2h (194 decimal)

Threshold: None

Description: The Temperature attribute indicates the current drive temperature in degrees Celsius.

See the following table for the byte definitions.

Byte	Value	Description
0	C2h	This is the attribute ID (194 decimal).
1-2	00h	Set to 0200h to indicate the attribute does not trigger an imminent failure (that is, the pre-fail advisory bit is not set).
3	64h	Each of these bytes is set to a constant value, which is always 64h (100 decimal).
4	64h	
5	As description	This byte indicates the current temperature in degrees Celsius. Valid values are D8h to 7Dh (-40 to +125).
6-11	00h	Reserved

9.3 Identify Device Data

The following table details the sector data returned after issuing an IDENTIFY DEVICE command.

Word	F=Fixed V=Variable X=Both	Default Value	Description
0	F	0040h	General configuration bit-significant information
1	F	3FFFh	Obsolete-Number of logical cylinders (16,383)
2	F	C837h	Specific configuration
3	F	0010h	Obsolete-Number of logical heads (16)
4-5	F	0000h	Retired
6	F	003Fh	Obsolete-Number of logical sectors per logical track (63)
7-8	F	0000h	Reserved for assignment by the Compact Flash Association
9	F	0000h	Retired
10-19	V	Var.	Serial number (20 ASCII characters)
20-22	F	0000h	Retired / Obsolete
23-26	V	Var.	Firmware revision (8 ASCII characters)
27-46	V	Var.	Model number
47	F	8010h	7:0 – Maximum number of sectors transferred per

			interrupt on multiple commands
48	F	4000h	Trusted Computing feature set options, bit14 should be 1
49	F	2F00h	Capabilities
50	F	4000h	Trusted Computing feature set options, bit14 should be 1
51-52	F	0000h	Obsolete
53	F	0007h	Words 88 and 70:64 valid
54	V	Var.	Obsolete - Number of logical cylinders (16,383)
55	V	Var.	Obsolete - Number of logical heads (16)
56	V	Var.	Obsolete - Number of logical sectors per logical track (63)
57-58	V	Var.	Capacity(Cylinders*heads*sectors)
59	V	0101h	Number of sectors transferred per interrupt on multiple commands
60-61	V	B2DE6B0h(96G) EE7C2B0h(128G) FFFFFFFFh(256G) FFFFFFFFh(512G) FFFFFFFFh(1024G)	Total number of user addressable logical sectors for 28-bit commands (DWord)
62	F	0000h	Obsolete
63	V	0007h	Multi-word DMA modes supported/selected
64	F	0003h	PIO modes supported
65	F	0078h	Minimum multiword DMA transfer cycle time per word
66	F	0078h	Manufacture's recommended multiword DMA transfer cycle time
67	F	0078h	Minimum PIO transfer cycle time without flow control
68	F	0078h	Minimum PIO transfer cycle time with IORDY flow control
69-70	F	0000h	Reserved(for future command overlap and queuing)
71-74	F	0000h	Reserved for the IDENTIFY packet DEVICE command
75	F	001Fh	4:0 Maximum Queue depth-1=31
76	F	070Eh	Serial ATA capabilities
77	F	Var.	Current SATA model
78	F	004Ch	Serial ATA features supported
79	V	0040h	Serial ATA features enabled
80	F	01FEh	Major Version Number

81	F	0021h	Minor Version Number
82	F	346Bh	Commands and feature sets supported
83	F	7D01h	Commands and feature sets supported
84	F	4023h	Commands and feature sets supported
85	V	3469h	Commands and feature sets supported or enabled
86	V	BC01h	Commands and feature sets supported or enabled
87	F	4023h	Commands and feature sets supported or enabled
88	V	407Fh	Ultra DMA modes
89	F	0003h	Time required for security erase unit completion
90	F	0003h	Time required for enhanced security erase completion
91	F	0000h	Current advanced power management value
92	V	Var.	Master Password Identifier
93	V	0000h	Hardware reset result. The contents of bits (12:0) of this word shall change only during the execution of a hardware reset.
94	F	0000h	Current AAM value
95	F	0000h	Stream Minimum Request Size
96	F	0000h	Streaming Transfer Time – DMA
97	F	0000h	Streaming Access Latency - DMA and PIO
98-99	F	0000h	Streaming Performance Granularity
100-103	V	B2DE6B0h(96G) EE7C2B0h(128G) 1DCF32B0h(256G) 3B9E12B0h(512G) 773BD2B0h(1024G)	Maximum user LBA for 48-bit Address feature set
104	F	0000h	Streaming Transfer Time – PIO
105	F	0008h	Maximum number of 512-byte blocks per DATA SET MANAGEMENT command
106	F	4000h	Physical sector size/logical sector size
107	F	0000h	Inter-seek delay for ISO-7779 acoustic testing in microseconds
108-111	V	0000h 0000h 0000h 0000h	Worldwide name
112-115	F	0000h	Reserved for word wide name extension to 128 bits
116	F	0000h	Reserved for TLC
117-118	F	0000h	Words per logical sector

K8-L1128/K8-L1256/K8-L1512/K8-L11T0 Engineering Specification

119	F	4010h	Commands and feature sets supported
120	F	4010h	Commands and feature sets supported or enabled
121-126	F	0000h	Reserved for expanded supported and enabled settings
127	F	0000h	Removable Media Status Notification feature set support
128	V	0021h	Security status
129-159	F	0000h	Vendor specific
160	F	0000h	Compact Flash Association (CFA) power mode 1
161-167	F	0000h	Reserved for the CompactFlash Association
168	F	0000h	
169	F	0001h	DATA SET MANAGEMENT command is supported
170-173	F	0000h	Additional Product Identifier (ATA String)
174-175	F	0000h	Reserved
176-205	F	0000h	Current media serial number (ATA string)
206	F	003Dh	SCT Command Transport
207-208	F	0000h	Reserved
209	F	4000h	Alignment of logical blocks within a physical block
210-211	F	0000h	Write-Read-Verify Sector Count Mode 3 (DWord)
212-213	F	0000h	Write-Read-Verify Sector Count Mode 2 (DWord)
214	F	0000h	NV Cache Capabilities
215-216	F	0000h	NV Cache Size in Logical Blocks (DWord)
217	F	0001h	Nominal media rotation rate
218	F	0000h	Reserved
219	F	0000h	NV Cache Options
220	F	0000h	7:0 Write-Read-Verify feature set current mode
221	F	0000h	Reserved
222	F	1075h	Transport major version number
223	F	0000h	Transport minor version number
224-229	F	0000h	Reserved
230-233	F	0000h	Extended Number of User Addressable Sectors (QWord)
234	F	0000h	Minimum number of 512-byte data blocks per DOWNLOAD MICROCODE command for mode 03h
235	F	0000h	Minimum number of 512-byte data blocks per DOWNLOAD MICROCODE command for mode 03h
236-254	F	0000h	Reserved
255	V	Var.	Integrity word

References

This document references standards defined by a variety of organizations as listed below.

Date	Title	Location
Dec 2008	VCCI	http://www.vcci.or.jp/vcci_e/general/join/index.html
July 2007	ROHS	Search for material description datasheet at http://intel.pcnaalert.com
April 2004	ATA-7 Spec. Volume 1	http://www.t13.org/
Aug. 2009	ATA-8 Spec. Rev 2	http://www.t13.org/
2008 2008 2004 2005 2008 2008	International Electro Technical Commission EB61000 4-2 Personnel Electrostatic Discharge Immunity 4-3 Electromagnetic compatibility (EMC) 4-4 Electromagnetic compatibility (EMC) 4-5 Electromagnetic compatibility (EMC) 4-6 Electromagnetic compatibility (EMC) 4-11 (Voltage variations)	http://www.iec.ch
2004	ENV 50204 (Radiated electromagnetic field from digital radio telephones)	http://www.iec.ch
2012	HSR027-12SSDX-0108__LITE-ON IT SSD technology 2012_09_07_V03.pdf	Lite-On IT

Terms and Acronyms

This document incorporates many industry and device specific words use the following list to define a variety of terms and acronyms.

Term	Definition
ATA	Advanced Technology Attachment
ATAPI	Advanced Technology Attachment Packet Interface
DIPM	Device Initiated Power Management The ability of the device to request SATA link power state changes
DMA	Direct Memory Access
DRAM	Dynamic Random Access Memory
GB	Giga-byte defined as 1×10^9 bytes
Hot Plug	A term used to describe the removal or insertion of a SATA hard drive when the system is powered on
IOPS	Input output operations per second
LBA	Logical Block Address
MB	Mega-bytes defined as 1×10^6 bytes
MTBF	Mean time between failure
NOP	No operation
OS	Operation System
SMART	Self-Monitoring, Analysis and reporting Technology An open standard for developing hard drive and software systems that automatically monitors a hard drive's health and reports potential problems
SSD	Solid State Drive
Write Cache	A memory device within a hard drive, which is allocated for the temporary storage of data before that data is copied to its permanent storage location
VCCI	Voluntary Control Council for Interface

Table 18: Glossary of Terms and Acronyms