

Basic Characteristics Data

Model	Circuit method	Switching frequency [kHz]	Input current [A]	Rated input fuse	Inrush current protection	PCB/Pattern			Series/Parallel operation availability	
						Material	Single sided	Double sided	Series operation	Parallel operation
DBS100A	Forward converter	370	1.10 *1	-	-	Aluminum	Yes		Yes	Yes
DBS150A	Forward converter	370	1.59 *1	-	-	Aluminum	Yes		Yes	Yes
DBS200B	Forward converter	370	0.99 *1	-	-	Aluminum	Yes		Yes	Yes
DBS400B	Forward converter	370	1.72 *1	-	-	Aluminum	Yes		Yes	Yes
DBS700B	Forward converter	381	2.76 *1	-	-	Aluminum	Yes		Yes	Yes

*1 The value of input current is at rated input and rated load.

1	Pin Connection	DBS-12
2	Connection for Standard Use	DBS-12
3	Wiring Input/Output Pin	DBS-12
3.1	Wiring input pin	DBS-12
3.2	Wiring output pin	DBS-13
4	Function	DBS-14
4.1	Overcurrent protection	DBS-14
4.2	Overvoltage protection	DBS-14
4.3	Thermal detection/Thermal protection	DBS-14
4.4	Inverter operation monitor	DBS-14
4.5	Remote ON/OFF	DBS-15
4.6	Remote sensing	DBS-15
4.7	Adjustable voltage range	DBS-16
4.8	Isolation	DBS-16
5	Series and Parallel Operation	DBS-17
5.1	Series operation	DBS-17
5.2	Parallel operation/Master-slave operation	DBS-17
5.3	N+1 redundant operation	DBS-17
6	Implementation · Mounting Method	DBS-18
6.1	Mounting method	DBS-18
6.2	Stress onto the pins	DBS-18
6.3	Cleaning	DBS-18
6.4	Soldering	DBS-18
6.5	Derating	DBS-18

1 Pin Connection

Table 1.1 Pin connection and function

NO.	Pin Connection	Function
①	+VIN	+DC input
②	-VIN	-DC input
③	RC1	Remote ON/OFF(Input side)
④ ⑤ ⑥ ⑦	+VOUT	+DC output
⑧ ⑨ ⑩ ⑪	-VOUT	-DC output
⑫	CB	Current balance
⑬	VB	Voltage balance
⑭	TMP	Thermal detection signal
⑮	RC3	Remote ON/OFF(output side)
⑯	RC2	
⑰	TRM	Adjustment of output voltage
⑱	+S	+Remote sensing
⑲	-S	-Remote sensing
⑳	IOG	Inverter operation monitor
㉑	AUX	Auxiliary power supply
—	FG	Mounting hole(FG)

NO.	Pin Connection	Reference
①	+VIN	3.1 "Wiring input pin"
②	-VIN	
③	RC1	4.5 "Remote ON/OFF"
④ ⑤ ⑥ ⑦	+VOUT	3.2 "Wiring output pin"
⑧ ⑨ ⑩ ⑪	-VOUT	
⑫	CB	5.2 "Parallel operation/Master-slave operation"
⑬	VB	
⑭	TMP	4.3 "Thermal detection/Thermal protection"
⑮	RC3	4.5 "Remote ON/OFF"
⑯	RC2	
⑰	TRM	4.7 "Adjustable voltage range"
⑱	+S	4.6 "Remote sensing"
⑲	-S	
⑳	IOG	4.4 "Inverter operation monitor"
㉑	AUX	4.5 "Remote ON/OFF"
—	FG	3.1 "Wiring input pin"

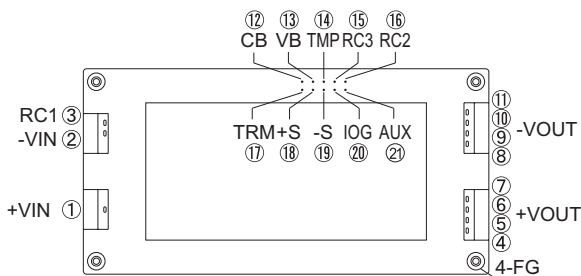

Fig. 1.1 Pin connection(bottom view)

2 Connection for Standard Use

■ In order to use the power supply, it is necessary to wire as shown in Fig.2.1 and external components in table2.1.

■ Short the following pins to turn on the power supply.

-VIN↔RC1, +VOUT↔+S, -VOUT↔-S
 { Reference: 4.5 "Remote ON/OFF"
 4.6 "Remote sensing" }

■ The DBS Series handles only the DC input.

Avoid applying AC input directly.

It will damage the power supply.

■ Operate with the conduction cooling(e.g. heat radiation from the aluminum base plate to the attached heat sink).

{ Reference: 6.5 "Derating" }

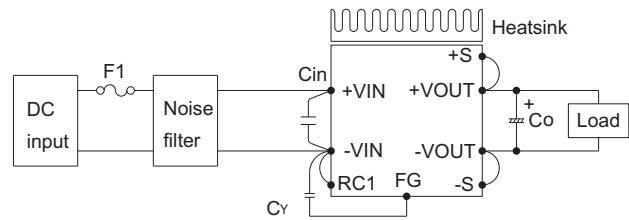

Fig.2.1 Connection for standard use

Table 2.1 External components

No.	Symbol	component	Reference
1	F1	Input fuse	3.1 (1) "External fuse"
2	Cy	Primary decoupling capacitor	3.1 (2) "Noise filter/Decoupling capacitor"
3	—	Noise filter	
4	Cin	External capacitor on the input side	3.1 (3) "External capacitor on the input side"
5	Co	External capacitor on the output side	3.2 "Wiring output pin"
6	—	Heatsink	6.5 "Derating"

3 Wiring Input/Output Pin

3.1 Wiring input pin

(1) External fuse

■ Fuse is not built-in on input side. In order to protect the unit, install the normal blow type fuse on input side.

■ When the input voltage from a front end unit is supplied to multiple units, install the normal blow type fuse in each unit.

Table 3.1 Recommended fuse(Normal-blow type)

Model	DBS100A / 150A	DBS200B	DBS400B	DBS700B
Rated current	5A	3A	5A	10A

(2) Noise filter/Decoupling capacitor

- Install an external noise filter and a decoupling capacitor C_Y for low line-noise and for stable operation of the power supply.
- Install a correspondence filter, if a noise standard meeting is required or if the surge voltage may be applied to the unit.
- Install a primary decoupling capacitor C_Y , with more than 470pF, near the input pins(within 50mm from the pins).
- When the total capacitance of the primary decoupling capacitor is more than 8800pF, the nominal value in the specification may not be met by the Hi-Pot test between input and output. In this case, it is that a capacitor should be installed between output and FG.

(3) External capacitor on the input side

- Install an external capacitor C_{in} between +VIN and -VIN input pins for low line-noise and for stable operation of the power supply.

DBS100A / 150A:more than 47 μ F
DBS200B:more than 0.1 μ F
DBS400B / 700B:more than 0.33 μ F

- When the line impedance is high or the input voltage rise quickly at start-up(less than 10 μ s), install a capacitor C_{in} between +VIN and -VIN input pins(within 50mm from pins).

DBS200B:more than 22 μ F
DBS400B / 700B:more than 47 μ F

(4) Input voltage rang/Input current range

- The specification of input ripple voltage is shown as below.

Ripple voltage DBS100A / 150A:less than 10Vp-p
DBS200B / 400B / 700B:less than 20Vp-p
- Make sure that the voltage fluctuation, including the ripple voltage, will not exceed the input voltage range.
- Use a front end unit with enough power, considering the start-up current I_p of this unit.

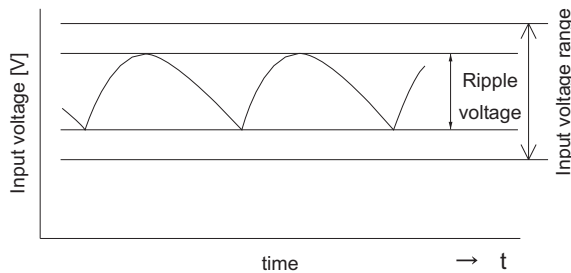

Fig.3.1 Input voltage ripple

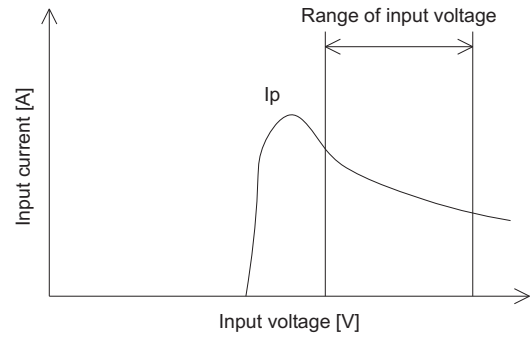

Fig.3.2 Input current characteristics

(5) Operation with AC input

- The DBS series handles only for the DC input. A front end unit(AC/DC unit) is required when the DBS series is operated with AC input.

(6) Reverse input voltage protection

- Avoid the reverse polarity input voltage. It will break the power supply. It is possible to protect the unit from the reverse input voltage by installing an external diode.

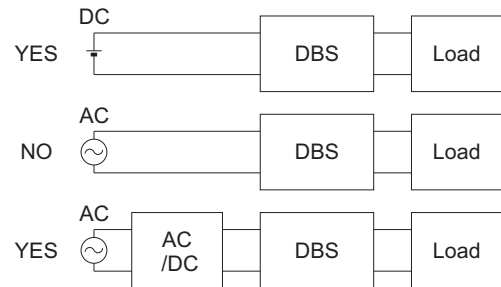

Fig.3.3 Use with AC input

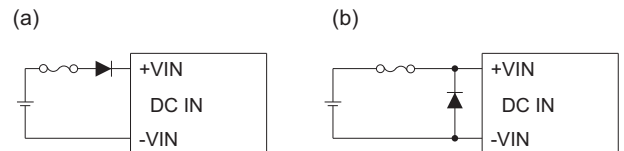

Fig.3.4 Reverse input voltage protection

3.2 Wiring output pin

- Install an external capacitor C_o between +VOUT and -VOUT pins for stable operation of the power supply. Recommended capacitance of C_o is shown in Table 3.2.
- Select the high frequency type capacitor. Output ripple and start-up waveform may be influenced by ESR·ESL of the capacitor and the wiring impedance.
- Install a capacitor C_o near the output pins(within 100mm from the pins).

Table 3.2 Recommended capacitance Co [μ F]

Model Output voltage (V)	DBS100A DBS150A	DBS200B	DBS400B	DBS700B
3.3	—	2200	6800	—
5	2200	2200	4700	—
7.5	—	2200	4700	—
12	1000	1000	2200	2200★
13.8	1000	—	—	—
15	1000	—	2200	—
18	—	—	2200	—
24	470	—	820	2200★
28	—	—	820	2200★
36	—	—	—	2200★
48	—	—	—	1000★

★ When using power supply at -20°C or less, the recommended capacitance becomes 3 times.

■ The specified ripple and ripple noise are measured by the method introduced in Fig.3.5.

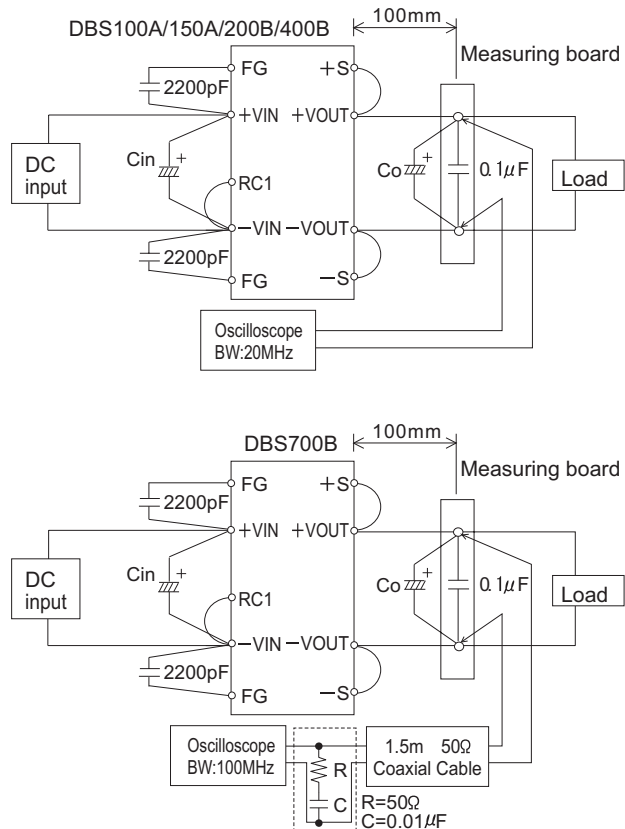

Fig.3.5 Method of Measuring Output Ripple and Ripple Noise

4 Function

4.1 Overcurrent protection

■ Overcurrent protection is built-in and comes into effect at over 105% of the rated current.

Overcurrent protection prevents the unit from short circuit and overcurrent condition. The unit automatically recovers when the fault condition is cleared.

■ When the output voltage drops at overcurrent, the average output current is reduced by intermittent operation of power supply.

4.2 Overvoltage protection

■ The overvoltage protection circuit is built-in. The DC input should be shut down if overvoltage protection is in operation. The minimum interval of DC recycling for recovery is for 2 to 3 minutes(★).

★ The recovery time varies depending on input voltage and input capacity.

Remarks:

Please note that devices inside the power supply might fail when voltage more than rated output voltage is applied to output terminal of the power supply. This could happen when the customer tests the overvoltage performance of the unit.

4.3 Thermal detection/Thermal protection

■ Thermal detection(TMP) and protection circuit are built-in.

■ When overheat is detected, thermal detection signal(TMP) turns "L" from "H".

TMP circuit is designed as shown in Fig.4.1, and specification is shown as in Table 4.1.

■ When overheating continues after detecting the TMP signal, the output will be shut down by the thermal protection circuit.

When this function comes into effect, input voltage should be shut off, and eliminate all possible causes of overheat condition and lower the temperature of the unit to the normal level.

4.4 Inverter operation monitor

■ By using the inverter operation monitor(IOG), malfunction of the inverter can be monitored.

When inverter operation is in following mode ① or ②, IOG signal turns "H" from "L" within 1 second.

IOG circuit is designed as shown in Fig.4.1 and specification is shown in Table 4.1.

① Malfunction of inverter.

② The output voltage drops by 60% or less of the rated voltage.

③ When output wattage is decreased radically to less than 10% of rated wattage.

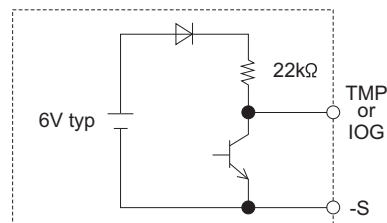

Fig.4.1 TMP, IOG circuit

Table 4.1 Specification of TMP, IOG

No.	Item	TMP	IOG
1	Function	Normal operation "H"	Normal operation "L"
		Overheat detection "L"	Malfunction of inverter "H"
2	Base pin	-S	
3	Level voltage "L"	0.5Vmax at 5mA	
4	Level voltage "H"	5V typ	
5	Maximum sink current	10mA max	
6	Maximum applicable voltage	35V max	

4.5 Remote ON/OFF

Remote ON/OFF circuit is built-in on both side of input(RC1) and output(RC2 · RC3).

Output can be controlled by either circuit.

(1) Input side remote ON/OFF(RC1)

The ground pin of input side remote ON/OFF circuit is "-VIN" pin. Between RC1 and -VIN: Output voltage is ON at "Low" level or short circuit(0 - 1.0V).

Between RC1 and -VIN: Output voltage is OFF at "High" level or open circuit(3.5 - 7.0V).

When RC1 is "Low" level, fan out current is 0.3mA typ. When V_{cc} is applied, use $3.5 \leq V_{cc} \leq 7V$.

When remote ON/OFF function is not used, please short between RC1 and -VIN.

When the DPA · DPF series(Power factor & harmonic corrector module) is used as a front end unit, connect between RC1 pin and PR pin on DPA(between RC1 pin and ENA pin on DPF) for the start-up timing of the DBS200B/400B/700B control.

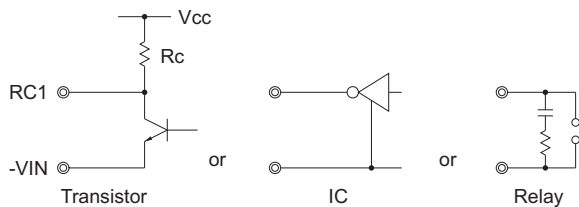

Fig.4.2 RC1 connection example

(2) Output side remote ON/OFF(RC2 · RC3)

Table 4.2 Specification of output side remote ON/OFF(RC2 · RC3)

No.	Item	RC2 · RC3		
1	Wiring method	Fig.4.3 (a)	Fig.4.3 (b)	Fig.4.3 (c)
2	Function	Power ON "H"	Power ON "H"	Power ON "L"
3	Base pin	RC2	-S	-S and RC2
4	Power ON	Open (0.1mA max)	Short (0.5V max)	
5	Power OFF	Short (3mA min)	Open (0.1mA max)	

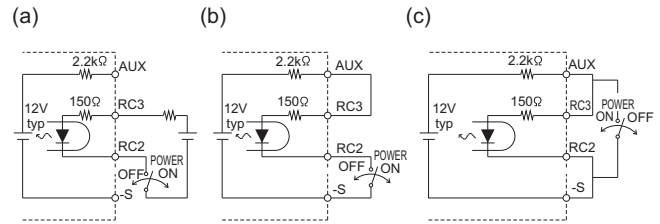

Fig.4.3 RC2 · RC3 connection example

Make sure that sink current of output side remote ON/OFF circuit should be less than 12mA.

(3) Auxiliary power supply for remote ON/OFF(AUX)

AUX is built in for operating the output side remote ON/OFF (RC2 · RC3).

If AUX is not used for RC2 · RC3, AUX can be used for IOG or TMP signal output by opto coupler.

Short protection resistance(2.2kΩ) is built in.

Output voltage decreases as the output current increases.

(AUX voltage at open circuit: 15V max)

4.6 Remote sensing

(1) When the remote sensing function is not in use

When the remote sensing function is not in use, it is necessary to confirm that pins are shorted between +S & +VOUT and between -S & -VOUT.

Wire between +S & +VOUT and between -S & -VOUT as short as possible.

Loop wiring should be avoided.

This power supply might become unstable by the noise coming from poor wiring.

(2) When the remote sensing function is in use

Twisted-pair wire or shield wire should be used for sensing wire.

Thick wire should be used for wiring between the power supply and a load.

Line drop should be less than 0.5V.

Voltage between +VOUT and -VOUT should remain within the output voltage adjustment range.

If the sensing patterns are short, heavy-current is drawn and the pattern may be damaged.

The pattern disconnection can be prevented by installing the protection parts as close as a load.

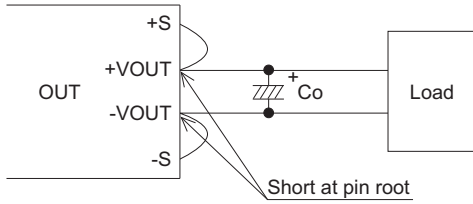

Fig.4.4 Connection when the remote sensing is not in use

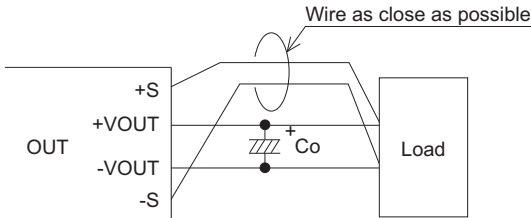

Fig.4.5 Connection when the remote sensing is in use

4.7 Adjustable voltage range

- Output voltage is adjustable by the external potentiometer or by applied voltage externally. The adjustable range is 60 - 110% of the rated output voltage.
- When the output voltage adjustment is used, note that the overvoltage protection circuit operates when the output voltage sets too high.

(1) Adjusting method by external resistor

- By connecting the external potentiometer (VR1) and resistors (R1, R2), output voltage becomes adjustable, as shown in Fig.4.6, recommended external parts are shown in Table 4.3.
- The wiring to the potentiometer should be as short as possible. The temperature coefficient becomes worse, depending on the type of a resistor and potentiometer. Following parts are recommended for the power supply.
Resistor ----- Metal film type, coefficient of less than $\pm 100\text{ppm}/^\circ\text{C}$
Potentiometer -- Cermet type, coefficient of less than $\pm 300\text{ppm}/^\circ\text{C}$
- When the output voltage adjustment is not used, open the TRM pin and VB pin respectively.

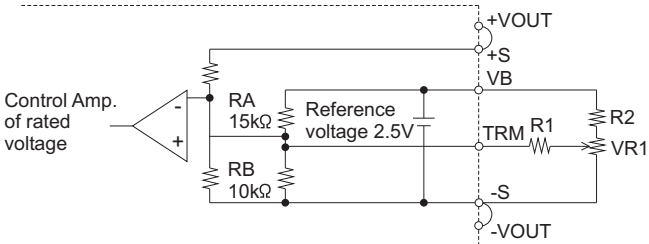

Fig.4.6 Output voltage control circuit

Table 4.3 Recommended value of external potentiometer & resistor

No.	Adjustable range [%]	Number of unit	External parts value [Ω]		
			VR1	R1	R2
1	± 5	Single	5k	75k	1k
2		2 sets		36k	
3		3 sets		24k	
4	± 10	Single	5k	36k	910
5		2 sets		18k	
6		3 sets		12k	

(2) Adjusting method by applying external voltage

- By applying the voltage externally at TRM, output voltage become adjustable.
- Output voltage is calculated by the following equation.
(Output voltage)
= (Applied voltage externally) \times (Rated output voltage)

- The output adjustment range for DBS700B is shown in Fig.4.7.

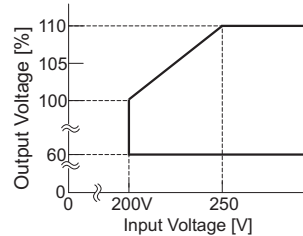

Fig.4.7 DBS700B Output Voltage Adjustment Range

4.8 Isolation

- For a receiving inspection, such as Hi-Pot test, gradually increase(decrease) the voltage for a start(shut down). Avoid using Hi-Pot tester with the timer because it may generate voltage a few times higher than the applied voltage, at ON/OFF of a timer.

5 Series and Parallel Operation

5.1 Series operation

■ Series operation is available by connecting the outputs of two or more power supplies, as shown below. Output current in series connection should be lower than the lowest rated current in each unit.

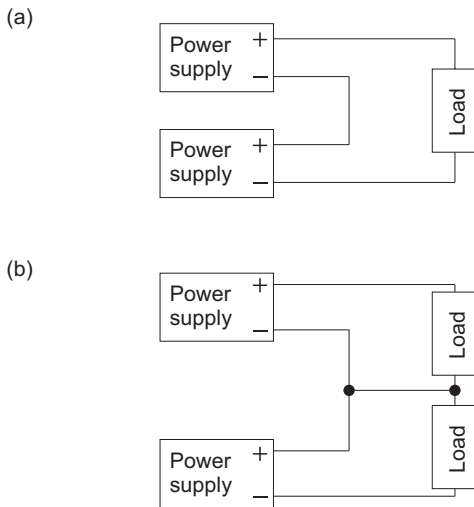

Fig.5.1 Examples of series operation

5.2 Parallel operation/Master-slave operation

■ Parallel operation is available by connecting the units as shown in Fig.5.2.

■ As variance of output current drawn from each power supply is maximum 10%, the total output current must not exceed the value determined by the following equation.

(Output current in parallel operation)

$$=(\text{the rated current per unit}) \times (\text{number of unit}) \times 0.9$$

When the number of units in parallel operation increases, input current increases at the same time. Adequate wiring design for input circuitry is required, such as circuit pattern, wiring and current capacity for equipment.

In parallel operation, the maximum operative number of units is 11.

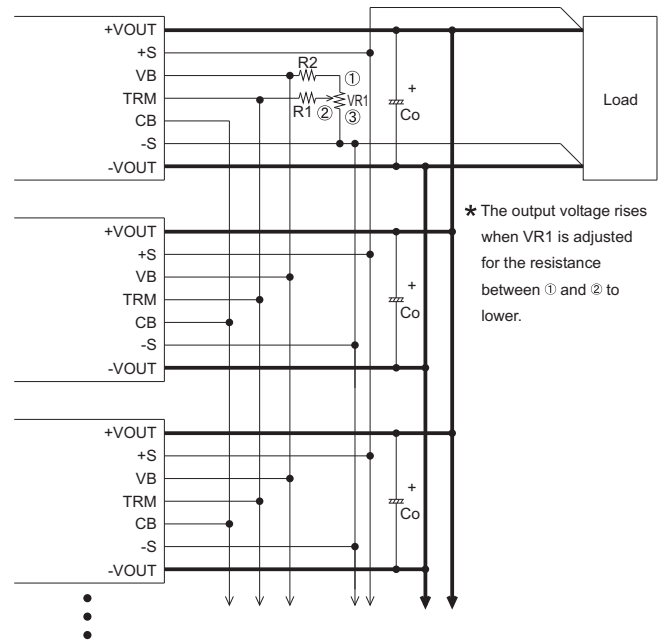

Fig.5.2 Examples of parallel operation

- When output voltage adjustment is not in use. TRM wiring, R1, R2 and VR are not necessary.
- Thick wire should be used for wiring between the power supply and load, and line drop should be less than 0.3V.
- When the output-line impedance is high, the power supply becomes unstable. Use same length and thickness (width) wire (pattern) for the current balance improvement.
- Connect each input pin for the lowest possible impedance.
- When the number of the units in parallel operation increases, input current increases. Adequate wiring design for input circuitry such as circuit pattern, wiring and current for equipment is required.
- Connect the sensing line and the power line by one point after connecting each power supply's sensing pins (+S, -S). In multiple operation, sensing wires should be connected between each unit for the master connection to a load.
- Output current should be 10% or more of the total of the rated output current in parallel operation. If less than 10%, the IOG signal might become unstable, and output voltage slightly increasing (max5%).
- IOG signal might be unstable for one second when the units are turned on in parallel operation.

5.3 N+1 redundant operation

- It is possible to set N+1 redundant operation for improving reliability of power supply system.
- Purpose of redundant operation is to ensure stable operation in the event of single power supply failure. Since extra power supply is reserved for the failure condition, so total power of redundant operation is equal to N-1.

6 Implementation · Mounting Method

6.1 Mounting method

- The unit can be mounted in any direction. When two or more power supplies are used side by side, position them with proper intervals to allow enough air ventilation. Aluminum base plate temperature around each power supply should not exceed the temperature range shown in derating curve.
- Avoid placing the DC input line pattern lay out underneath the unit, it will increase the line conducted noise. Make sure to leave an ample distance between the line pattern lay out and the unit. Also avoid placing the DC output line pattern underneath the unit because it may increase the output noise. Lay out the pattern away from the unit.
- High-frequency noise radiates directly from the unit to the atmosphere. Therefore, design the shield pattern on the printed circuit board and connect its one to FG. The shield pattern prevents noise radiation.

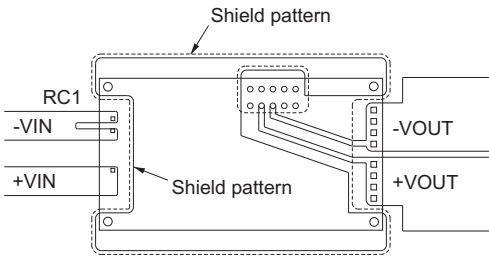

Fig.6.1 Shield pattern lay out(bottom view)

6.2 Stress onto the pins

- When too much stress is applied to the pins of the power supply, the internal connection may be weakened. As shown in Fig.6.2 avoid applying stress of more than 29.4N(3kgf) on the input pins/output pins(A part) and more than 9.8N(1kgf) to the signal pins(B part).
- The pins are soldered on PCB internally, therefore, do not pull or bend them with abnormal forces.
- Mounting hole diameter of PCB should be 3.5mm to reduce the stress onto the pins.
- Fix the unit on PCB(fixing fittings) by screws to reduce the stress onto the pins. Be sure to mount the unit first, then solder the unit.

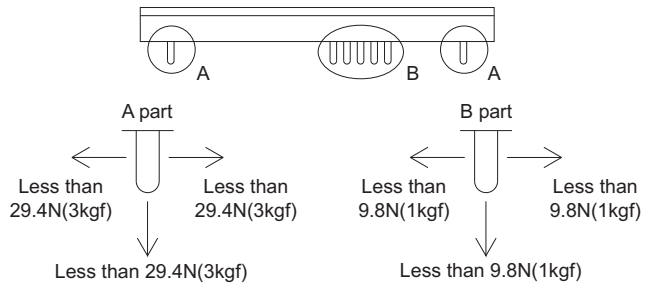

Fig.6.2 Stress onto the pins

6.3 Cleaning

- Clean the product with a brush. Prevent liquid from getting into the product. Do not soak the product into liquid.
- Do not stick solvent to a name plate or a resin case. (If solvent sticks to a name plate or a resin case, it will cause to change the color of the case or to fade letters on name plate away.)
- After cleaning, dry them enough.

6.4 Soldering

- Flow soldering : 260°C less than 15 seconds.
- Soldering iron
 - DC IN/DC OUT/RC1 : 450°C less than 5 seconds.
 - Signal pins : 350°C less than 3 seconds(less than 20w).

6.5 Derating

- Use with the conduction cooling(e.g. heat radiation by conduction from the aluminum base plate to the attached heat sink). Fig.6.3 shows the derating curve based on the aluminum base plate temperature. In the hatched area, the specification of ripple and ripple noise is different from other areas.
- It is necessary to note thermal fatigue life by power cycle. Please reduce the temperature fluctuation range as much as possible when the up and down of temperature are frequently generated.

Contact for more information on cooling methods.

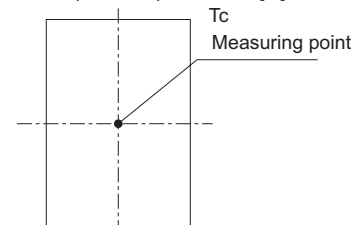
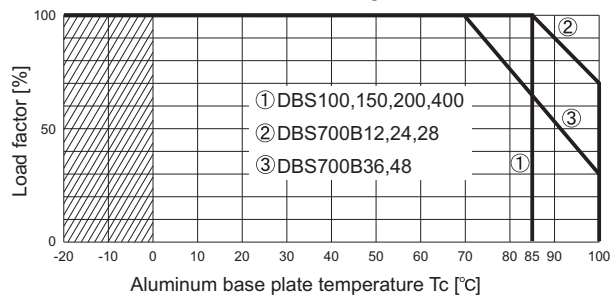

Fig.6.3 Derating curve