

## Hybrid

### Conductive Polymer Hybrid Aluminum Electrolytic Capacitors

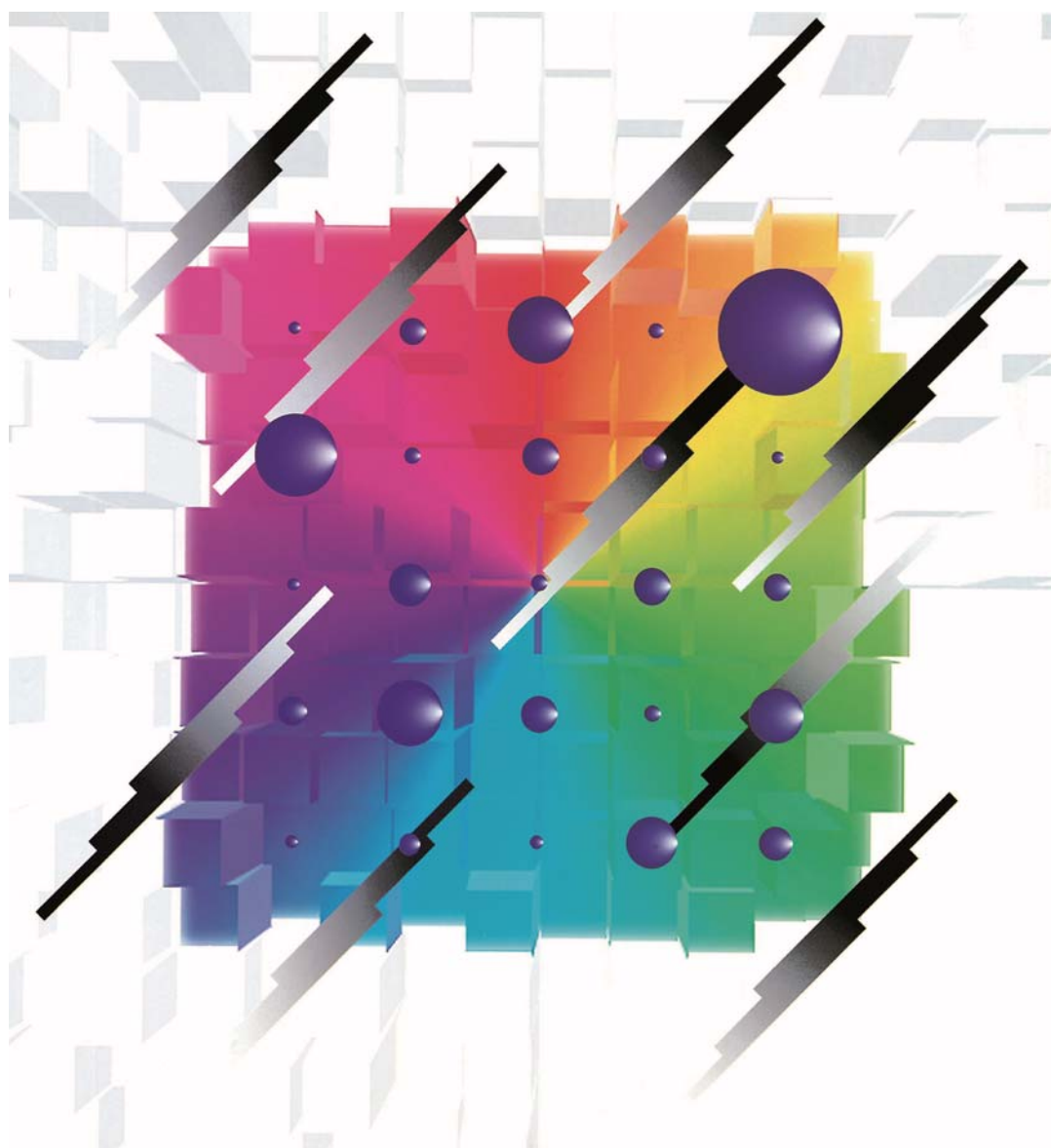

## Notices

### ■ Applicable Laws and Regulations

- This product complies with the RoHS Directive (Restriction of the use of certain Hazardous substances in electrical and electronic equipment (DIRECTIVE 2011/65/EU).
- No Ozone Depleting Chemicals(ODC's), controlled under the Montreal Protocol Agreement, are used in producing this product.
- We do not use PBBs or PBDEs as brominated flame retardants.
- Export procedure which followed export related regulations, such as foreign exchange and a foreign trade method, on the occasion of export of this product.

### ■ Limited applications

- This capacitor is designed to be used for electronics circuits such as audio/visual equipment, home appliances, computers and other office equipment, optical equipment, measuring equipment.
- High reliability and safety are required [ be / a possibility that incorrect operation of this product may do harm to a human life or property ] more. When use is considered by the use, the delivery specifications which suited the use separately need to be exchanged.

## Items to be observed

- This specification guarantees the quality and performance of the product as individual components. Before use, check and evaluate their compatibility with installed in your products.
- Do not use the products beyond the specifications described in this document.

### ■ For specifications

- Install the following systems for a failsafe design to ensure safety if these products are to be used in equipment where a defect in these products may cause the loss of human life or other signification damage, such as damage to vehicles (automobile, train, vessel), traffic lights, medical equipment, aerospace equipment, electric heating appliances, combustion/ gas equipment, rotating rotating equipment, and disaster/crime prevention equipment.
  - The system is equipped with a protection circuit and protection device.
  - The system is equipped with a redundant circuit or other system to prevent an unsafe status in the event of a single fault.

### ■ Conditions of use

- Before using the products, carefully check the effects on their quality and performance, and determined whether or not they can be used. These products are designed and manufactured for general-purpose and standard use in general electronic equipment. These products are not intended for use in the following special conditions.
  - (1) In liquid, such as Water, Oil, Chemicals, or Organic solvent.
  - (2) In direct sunlight, outdoors, or in dust.
  - (3) In vapor, such as dew condensation water of resistive element, or water leakage, salty air, or air with a high concentration corrosive gas, such as Cl<sub>2</sub>, H<sub>2</sub>S, NH<sub>3</sub>, SO<sub>2</sub>, or NO<sub>x</sub>.
  - (4) In an environment where strong static electricity or electromagnetic waves exist.
  - (5) Mounting or placing heat-generating components or inflammables, such as vinyl-coated wires, near these products.
  - (6) Sealing or coating of these products or a printed circuit board on which these products are mounted, with resin and other material.
  - (7) Using solvent, water or water-soluble cleaner for flux cleaning agent after soldering. (In particular, when using water or a water-soluble cleaning agent, be careful not to leave water residues)
  - (8) Using in the atmosphere which strays Acid or alkaline.
  - (9) Using in the atmosphere which there are excessive vibration and shock.
- Please arrange circuit design for preventing impulse or transitional voltage. Do not apply voltage, which exceeds the full rated voltage when the capacitors receive impulse voltage, instantaneous high voltage, high pulse voltage etc.
- Our products there is a product are using an electrolyte solution. Therefore, misuse can result in rapid deterioration of characteristics and functions of each product. Electrolyte leakage damages printed circuit and affects performance, characteristics, and functions of customer system.

## ⚠ Application Guidelines (Hybrid)

### 1. Circuit design

#### 1.1 Operating Temperature and Frequency

Electrical characteristics of the capacitor are likely to change due to variation in temperature and/or frequency. Circuit designers should take these changes into consideration.

- (1) Effects of operating temperature on electrical parameters
  - (a) At higher temperatures, leakage current and capacitance increase while equivalent series resistance (ESR) decreases.
  - (b) At lower temperatures, leakage current and capacitance decrease while equivalent series resistance (ESR) increases.
- (2) Effects of frequency on electrical parameters
  - (a) At higher frequencies, capacitance and impedance decrease while  $\tan \delta$  increases.
  - (b) At lower frequencies, heat generated by ripple current will rise due to an increase in equivalent series resistance (ESR).

#### 1.2 Operating Temperature and Life Expectancy

- (1) Expected life is affected by operating temperature. Generally, each 10 °C reduction in temperature will double the expected life. Use capacitors at the lowest possible temperature below the upper category temperature.
- (2) If operating temperatures exceed the upper category limit, rapid deterioration of electrical parameter will occur and irreversible damage will result.  
Check for the maximum capacitor operating temperatures including ambient temperature, internal capacitor temperature rise due to ripple current, and the effects of radiated heat from power transistors, IC's or resistors.  
Avoid placing components, which could conduct heat to the capacitor from the back side of the circuit board.
- (3) The formula for calculating expected life at lower operating temperatures is as follows ;

$$L_2 = L_1 \times 2^{\left(\frac{T_1 - T_2}{10}\right)}$$

$L_1$  : Guaranteed life (h) at temperature,  $T_1$  °C

$L_2$  : Expected life (h) at temperature,  $T_2$  °C

$T_1$  : Upper category temperature + temperature rise due to rated ripple current (°C)

$T_2$  : Actual operating temperature, ambient temperature + temperature rise due to ripple current (°C)

- (4) Please use according to the lifetime as noted in this specification. Using products beyond end of the lifetime may change characteristics rapidly, short-circuit, operate pressure relief vent, or leak electrolyte.

#### 1.3 Common Application Conditions to Avoid

The following misapplication load conditions will cause rapid deterioration of a capacitor's electrical parameters. In addition, rapid heating and gas generation within the capacitor can occur, causing the pressure relief vent to operate and resultant leakage of electrolyte. Under extreme conditions, explosion and fire ignition could result. The leaked electrolyte is combustible and electrically conductive.

- (1) Reverse Voltage  
DC capacitors have polarity. Therefore, please do not apply the reverse voltage. Verify correct polarity before insertion.
- (2) Charge / Discharge Applications  
Standard capacitors are not suitable for use in repeating charge/discharge applications. For charge/discharge applications, consult us with your actual application condition.  
For rush current, please to not exceed 100 A.
- (3) ON-OFF circuit  
Do not use capacitors in circuit where ON-OFF switching is repeated more than 10000 times/per day.  
In case of applying to the theses ON-OFF circuit, consult with us about circuit condition and so on.
- (4) Over voltage  
Do not apply voltages exceeding the maximum specified rated voltage. Voltages up to the surge voltage rating are acceptable for short periods of time.  
Ensure that the sum of the DC voltage and the superimposed AC ripple voltage does not exceed the rated voltage
- (5) Ripple Current  
Do not apply ripple currents exceeding the maximum specified value. For high ripple current applications, use a capacitor designed for high ripple currents. In addition, consult us if the applied ripple current is to be higher than the maximum specified value. Ensure that rated ripple currents that superimposed on low DC bias voltages do not cause reverse voltage conditions.  
Even if it is within a rated ripple current, in case the practical use is over the pre described endurance life time, it causes the increase of deterioration of ESR characteristic and the internal generation heat by ripple current.  
Due to this, there is some possibility of vent open, bulging of sleeve and rubber, electrolyte leakage, and shot circuit, explosion and ignition in the worst case.

#### 1.4 Using Two or More Capacitors in Parallel

The circuit resistance can closely approximate the series resistance of the capacitor, causing an imbalance of ripple current loads within the capacitors. Careful wiring methods can minimize the possible application of an excessive ripple current to a capacitor.

Moreover, please do not use it in series.

#### 1.5 Capacitor Mounting Considerations

##### (1) Double-Sided Circuit Boards

Avoid wiring pattern runs, which pass between the mounted capacitor and the circuit board.

##### (2) Clearance for Case Mounted Pressure Relief ( $\geq \phi 10$ mm)

Capacitors with case mounted pressure relief require sufficient clearance to allow for proper pressure relief operation.

The minimum clearance are dependent on capacitor diameters as follows.

·  $\geq \phi 10$  mm : 2 mm minimum

##### (3) Wiring Near the Pressure Relief ( $\geq \phi 10$ mm)

Avoid locating high voltage or high current wiring or circuit board paths above the pressure relief. Flammable, high temperature gas that exceeds 100 °C may be released which could dissolve the wire insulation and ignite.

##### (4) Circuit Board Patterns Under the Capacitor

Avoid circuit board runs under the capacitor, as an electrical short can occur due to an electrolyte leakage.

#### 1.6 Electrical Isolation of the Capacitor

Completely isolate the capacitor as follows.

· Between the cathode and the case and between the anode terminal and other circuit paths.

#### 1.7 Capacitor Coating

The laminate coating is intended for marking and identification purposes and is not meant to electrically insulate the capacitor.

### 2. Capacitor Handling Techniques

#### 2.1 Considerations Before Using

(1) Capacitors have a finite life. Do not reuse or recycle capacitors from used equipment.

(2) Transient recovery voltage may be generated in the capacitor due to dielectric absorption.

If required, this voltage can be discharged with a resistor with a value of about 1 k $\Omega$ .

(3) Capacitors stored for a long period of time may exhibit an increase in leakage current.

This can be corrected by gradually applying rated voltage in series with a resistor of approximately 1 k $\Omega$ .

(4) If capacitors are dropped, they can be damaged mechanically or electrically. Avoid using dropped capacitors.

(5) Dented or crushed capacitors should not be used.

The seal integrity can be damaged and loss of electrolyte/ shortened life can result.

#### 2.2 Capacitor Insertion

(1) Verify the correct capacitance and rated voltage of the capacitor.

(2) Verify the correct polarity of the capacitor before insertion.

(3) Verify the correct terminal dimension and land pattern size before mount to avoid stress on the terminals.

(4) Excessive mounting pressure can cause high leakage current, short circuit, or disconnection.

#### 2.3 Reflow Soldering

(1) Surface-mount type capacitor are exclusively for reflow soldering.

When reflow solder is used an ambient heat condition system such as the simultaneous use of infrared and hot-air is recommended.

(2) Observe proper soldering conditions (temperature, time, etc.). Do not exceed the specified limits.

\* The Temperature on Capacitor top shall be measured by using thermal couple that is fixed firmly by epoxy glue.

(3) In case of use in 2 times reflow, 2nd reflow must be done when the capacitor's temperature return back to normal level.

(4) In our recommended reflow condition, the case discoloration and the case swelling might be slightly generated.

But please acknowledge that these two phenomena do not influence the reliability of the product.

(5) The crack on top marking might be occurred by reflow heat stress.

But please acknowledge that it does not influence the reliability of the product.

(6) VPS (Vapor Phase Soldering) reflow can cause significant characteristics change and/ or mounting failure due to deformation by acute temperature rise.

VPS is acceptable provided that the process does not exceed recommended reflow profile and temperature rise is less than 3 degC/sec.

Please contact Panasonic for detailed conditions.

## 2.4 Manual Soldering

- (1) Observe temperature and time soldering specifications or do not exceed temperature of 350 °C for 3 seconds or less.
- (2) If a soldered capacitor must be removed and reinserted, avoid excessive stress on the capacitor leads.
- (3) Avoid physical contacts between the tip of the soldering iron and capacitors to prevent or capacitor failure.

## 2.5 Capacitor Handling after Soldering

- (1) Avoid moving the capacitor after soldering to prevent excessive stress on the lead wires where they enter the seal. The capacitor may break from element portion due to a torque at outer rim, causing a large stress to terminals.
- (2) Do not use the capacitor as a handle when moving the circuit board assembly. The total weight of the board would apply to element portion through terminals, and the capacitor may break.
- (3) Avoid striking the capacitor after assembly to prevent failure due to excessive shock. The capacitor may break due to excessive shock or load above specified range.

## 2.6 Circuit Board Cleaning

- (1) Circuit boards can be immersed or ultrasonically cleaned using suitable cleaning solvents for up to 5 minutes and up to 60 °C maximum temperatures. The boards should be thoroughly rinsed and dried.  
The use of ozone depleting cleaning agents is not recommended for the purpose of protecting our environment.
- (2) Avoid using the following solvent groups unless specifically allowed in the specification ;
  - (a) Halogenated cleaning solvents : except for solvent resistant capacitor types, halogenated solvents can permeate the seal and cause internal capacitor corrosion and failure.  
For solvent resistant capacitors, carefully follow the temperature and time requirements based on the specification. 1,1,1-trichloroethane should never be used on any aluminum electrolytic capacitor.
  - (b) Alkaline solvents : could react and dissolve the aluminum case.
  - (c) Petroleum based solvents : deterioration of the rubber seal could result.
  - (d) Xylene : deterioration of the rubber seal could result.
  - (e) Acetone : removal of the ink markings on the vinyl sleeve could result.
- (3) A thorough drying after cleaning is required to remove residual cleaning solvents that may be trapped between the capacitor and the circuit board. Avoid drying temperatures, which exceed the Upper category temperature of the capacitor.
- (4) Monitor the contamination levels of the cleaning solvents during use in terms of electrical conductivity, pH, specific gravity, or water content.  
Chlorine levels can rise with contamination and adversely affect the performance of the capacitor. Control the flux density in the cleaning agent to be less than 2 mass%.
- (5) Depending on the cleaning method, the marking on a capacitor may be erased or blurred.  
Please consult us if you are not certain about acceptable cleaning solvents or cleaning methods.

## 2.7 Mounting Adhesives and Coating Agents

When using mounting adhesives or coating agents to control humidity, avoid using materials containing halogenated solvents.

Also, avoid the use of chloroprene based polymers.

Harden on dry adhesive or coating agents well lest the solvent should be left.

After applying adhesives or coatings, dry thoroughly to prevent residual solvents from being trapped between the capacitor and the circuit board.

## 2.8 Fumigation

In exporting electronic appliances with aluminum electrolytic capacitors, in some cases fumigation treatment using such halogen compound as methyl bromide is conducted for wooden boxes.

If such boxes are not dried well, the halogen left in the box is dispersed while transported and enters in the capacitors inside.

This possibly causes electrical corrosion of the capacitors. Therefore, after performing fumigation and drying make sure that no halogen is left.

Don't perform fumigation treatment to the whole electronic appliances packed in a box.

Leave more than 1/3 of the sealing portion open, and do not cover that portion with any adhesives or coating.

## 3. Precautions for using capacitors

### 3.1 Environmental Conditions

Capacitors should not be stored or used in the following environments.

- (1) Exposure to temperatures above the upper category or below the lower category temperature of the capacitor.
- (2) Direct contact with water, salt water, or oil.
- (3) High humidity conditions where water could condense on the capacitor.
- (4) Exposure to toxic gases such as hydrogen sulfide, sulfuric acid, nitric acid, chlorine, Chlorine compound, Bromine, Bromine compound or ammonia.
- (5) Exposure to ozone, radiation, or ultraviolet rays.
- (6) Vibration and shock conditions exceeding specified requirements.

### 3.2 Electrical Precautions

- (1) Avoid touching the terminals of a capacitor as a possible electric shock could result. The exposed aluminum case is not insulated and could also cause electric shock if touched.
- (2) Avoid short circuiting the area between the capacitor terminals with conductive materials including liquids such as acids or alkaline solutions.
- (3) A low-molecular-weight-shiroxane which is included in a silicon material shall causes abnormal electrical characteristics.

### 4. Emergency Procedures

- (1) If the pressure relief of the capacitor operates, immediately turn off the equipment and disconnect from the power source.  
This will minimize an additional damage caused by the vaporizing electrolyte.
- (2) Avoid contact with the escaping electrolyte gas, which can exceed 100 °C temperatures.  
If electrolyte or gas enters the eye, immediately flush the eye with large amounts of water.  
If electrolyte or gas is ingested by mouth, gargle with water.  
If electrolyte contacts the skin, wash with soap and water.

### 5. Long Term Storage

Leakage current of a capacitor increases with long storage times. The aluminum oxide film deteriorates as a function of temperature and time.

If used without reconditioning, an abnormally high current will be required to restore the oxide film.

This surge current could cause the circuit or the capacitor to fail.

Expiration date is 42 months from outgoing inspection date.

For storage condition, keep room temperature (5 °C to 35 °C) and humidity (45 % to 85 %) where direct sunshine doesn't reach.

#### 5.1 Environmental Conditions

Do not store under condition outside the area described in the specification, and also under conditions listed below.

- (1) Exposure to temperatures above the upper category or below the lower category temperature of the capacitor.
- (2) Direct contact with water, salt water, or oil.
- (3) High humidity conditions where water could condense on the capacitor.
- (4) Exposure to toxic gases such as hydrogen sulfide, sulfuric acid, nitric acid, chlorine, Chlorine compound, Bromine, Bromine compound or ammonia.
- (5) Exposure to ozone, radiation, or ultraviolet rays.
- (6) Vibration and shock conditions exceeding specified requirements.

### 6. Capacitor Disposal

When disposing capacitors, use one of the following methods.

- (1) Incinerate after crushing the capacitor or puncturing the can wall (to prevent explosion due to internal pressure rise).
- (2) Dispose as solid waste.

NOTE : Local laws may have specific disposal requirements which must be followed.

### \* Intellectual property right

We, Panasonic Group are providing the product and service that customers can use without anxiety, and are working positively on the protection of our products under intellectual property rights.

Representative patents relating to Conductive Polymer Hybrid Aluminum Electrolytic Capacitors are as follows:

US Patent Nos. 7497879 and 7621970 JP Patent No. 5360250



### 一览表

#### 表面贴装型 (V型)

系列	型号	特长	小形产品	高耐热产品	低ESR产品	长寿命产品	范围 类别温度 (°C)	范围 额定电压 (V.DC)	ESR (mΩ)	范围 静电容量 (μF)	尺寸代码	尺寸 (mm)		
												φD	L	
ZA	EEHZA---	低ESR产品 高纹波产品 长寿命产品 105°C 10000 h 保证品	●	●	●	●	-55 ~ 105	25 ~ 50	80 ~ 120	10 ~ 33	C	5	5.8	
									25 ~ 63	50 ~ 120	10 ~ 56	D	6.3	5.8
										30 ~ 80	22 ~ 100	D8	6.3	7.7
									25 ~ 80	27 ~ 45	22 ~ 220	F	8	10.2
20 ~ 36	33 ~ 330	G	10	10.2										
ZC	EEHZC---	低ESR产品 高纹波产品 长寿命产品 125°C 4000 h 保证品	●	●	●	-55 ~ 125	25 ~ 50	80 ~ 120	10 ~ 33	C	5	5.8		
								25 ~ 63	50 ~ 120	10 ~ 56	D	6.3	5.8	
									30 ~ 80	22 ~ 100	D8	6.3	7.7	
								25 ~ 80	27 ~ 45	22 ~ 220	F	8	10.2	
20 ~ 36	33 ~ 330	G	10	10.2										
ZK	EEHZK---	大容量产品 高纹波产品 长寿命产品 125°C 4000 h 保证品	●	●	●	-55 ~ 125	25 ~ 35	80 ~ 100	33 ~ 47	C	5	5.8		
								50 ~ 60	56 ~ 68	D	6.3	5.8		
								30 ~ 35	100 ~ 150	D8	6.3	7.7		
								27	180 ~ 270	F	8	10.2		
								20	330 ~ 470	G	10	10.2		
ZE	EEHZE---	高耐热产品 高纹波产品 长寿命产品 / 145°C 2000 h 保证品	●	●	●	-55 ~ 145	25 ~ 63	27 ~ 40	33 ~ 220	F	8	10.2		
								20 ~ 30	56 ~ 330	G	10	10.2		

#### 径向引线型 (A型)

系列	型号	特长	小形产品	高耐热产品	低ESR产品	长寿命产品	范围 类别温度 (°C)	范围 额定电压 (V.DC)	ESR (mΩ)	范围 静电容量 (μF)	尺寸代码	尺寸 (mm)	
												φD	L
NEW ZF	EEHAZF---	高耐热产品 150°C 1000 h 保证品	●	●	●	●	-55 ~ 150	25 ~ 63	27 ~ 40	33 ~ 150	F	8	9.5
									20 ~ 30	56 ~ 270	G	10	9.5

### 体系图

#### 表面贴装型 (V型)

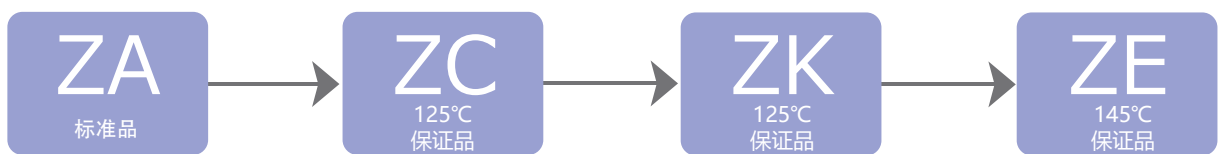

#### 径向引线型 (A型)



### 尺寸・ESR规格一览表

V.DC	系列	μF																
		10	22	27	33	47	56	68	82	100	120	150	180	220	270	330	470	
25	ZA				C (80)		D (50)			D8 (30)					F (27)		G (20)	
	ZC				C (80)		D (50)			D8 (30)					F (27)		G (20)	
	ZK					C (80)		D (50)					D8 (30)			F (27)		G (20)
	ZE														F (27)		G (20)	
	<b>NEW</b> ZF													F (27)			G (20)	
35	ZA		C (100)	D (60)		D (60)		D8 (35)						F (27)		G (20)		
	ZC		C (100)			D (60)		D8 (35)						F (27)		G (20)		
	ZK				C (100)		D (60)		D8 (35)				F (27)			G (20)		
	ZE													F (27)		G (20)		
	<b>NEW</b> ZF									F (30)				G (23)				
50	ZA	C (120)	D (80)			D8 (40)			F (30)		G (28)							
	ZC	C (120)	D (80)			D8 (40)			F (30)		G (28)	G (28)						
	ZE								F (30)		G (28)							
	<b>NEW</b> ZF								F (35)		G (28)							
63	ZA	D (120)	D8 (80)			F (40)		G (30)										
	ZC	D (120)	D8 (80)			F (40)		G (30)	G (30)	G (30)								
	ZE					F (40)		G (30)										
	<b>NEW</b> ZF					F (40)		G (30)										
80	ZA		F (45)			G (36)												
	ZC		F (45)			G (36)	G (36)											

尺寸代码

C	φ 5 x L5.8	F	φ 8 x L10.2
D	φ 6.3 x L5.8	G	φ 10 x L10.2
D8	φ 6.3 x L7.7		(单位: mm)
F	φ 8 x L9.5		
G	φ 10 x L9.5		

尺寸代码 (ESR mΩ)

V型 A型



## Mounting specification

### Specifications for surface mount type

- Reflow guaranteed condition

<RoHS compliant>

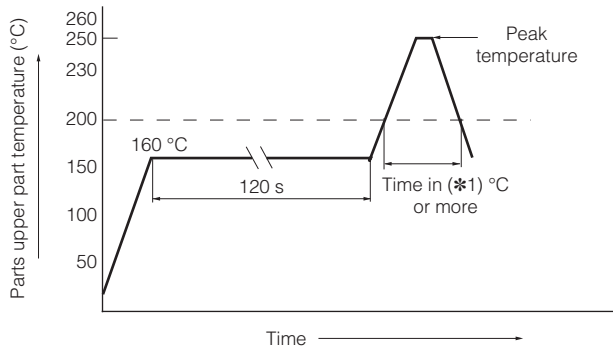

Size code	C, D, D8	F, G	
Peak temperature	260 °C(255 °C)	245 °C	260 °C
Time in peak temperature	≥ 250 °C 5 s (10 s)	≥ 240 °C 10 s	≥ 250 °C 5 s
Time in (*1) °C or more	≥ 230 °C 30 s	≥ 230 °C 30 s	≥ 230 °C 30 s
	≥ 217 °C 40 s	≥ 217 °C 40 s	≥ 217 °C 40 s
	≥ 200 °C 70 s	≥ 200 °C 70 s	≥ 200 °C 70 s
Time of reflow	2 times	2 times	1 times

\* For reflow, use a thermal condition system such as infrared radiation (IR) or hot blast.  
 \* Panasonic have several series available for pure Tin terminal and ZVEI reflow based on J-STD-020D (JEDEC). (Please contact sales for details.)

### Specifications for radial lead type

- Flow soldering condition

<RoHS compliant>

	Temperature	Time	Flow number
Soldering condition	260 °C+5 °C or less	10 °C+1 sec. or less	1 time

- Dimensions (Vibration-proof products)

The size and shape are different from standard products.  
 Please inquire details of our company.

<Size code D, D8>

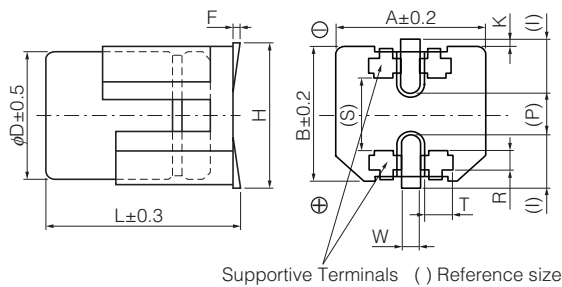

Unit : mm

Size code	φD	L	A, B	H max.	F	I	W
D	6.3	6.1	6.6	7.8	0 to +0.15	2.4	0.65±0.1
D8	6.3	8.0	6.6	7.8	0 to +0.15	2.4	0.65±0.1

Size code	P	K	R	S	T
D	2.2	0.35 <sup>+0.15</sup> <sub>-0.20</sub>	0.85	3.7	1.05
D8	2.2	0.35 <sup>+0.15</sup> <sub>-0.20</sub>	0.85	3.7	1.05

<Size code F, G>

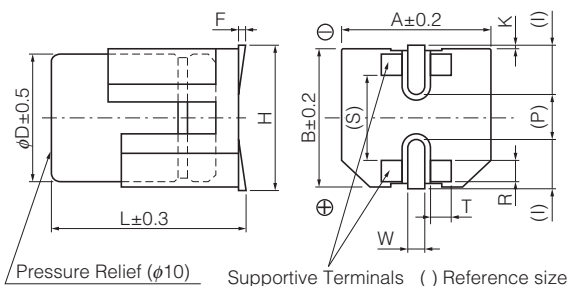

Unit : mm

Size code	φD	L	A, B	H max.	F	I	W
F	8.0	10.5	8.3	10.0	0 to +0.15	3.4	1.2±0.2
G	10.0	10.5	10.3	12.0	0 to +0.15	3.5	1.2±0.2

Size code	P	K	R	S	T
F	3.1	0.70±0.2	0.70±0.2	5.3±0.2	1.3±0.2
G	4.6	0.70±0.2	0.70±0.2	6.9±0.2	1.3±0.2

## ● Land/Pad pattern

The circuit board land/pad pattern size for chip capacitors is specified in the following table. The land pitch influences installation strength and consider it.

### <Standard products>

Unit : mm

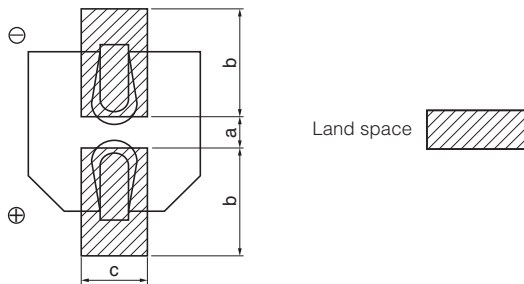

Size code	a	b	c
C ( $\phi 5 \times L5.8$ )	1.5	2.8	1.6
D ( $\phi 6.3 \times L5.8$ )	1.8	3.2	1.6
D8 ( $\phi 6.3 \times L7.7$ )	1.8	3.2	1.6
F ( $\phi 8 \times L10.2$ )	3.1	4.0	2.0
G ( $\phi 10 \times L10.2$ )	4.6	4.1	2.0

When size "a" is wide, back fillet can be made, decreasing fitting strength.

### <Vibration-proof products>

Unit : mm

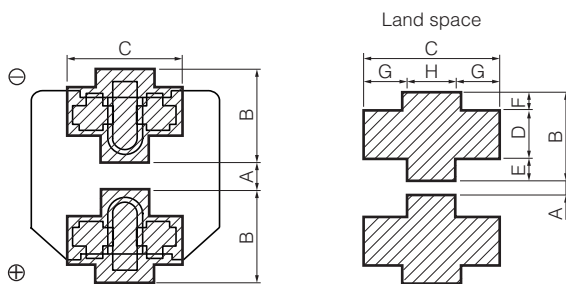

Size code	A	B	C	D
D ( $\phi 6.3 \times L6.1$ )	1.2	3.6	3.2	2.0
D ( $\phi 6.3 \times L8.0$ )	1.2	3.6	3.2	2.0

Size code	E	F	G	H
D ( $\phi 6.3 \times L6.1$ )	0.95	0.65	1.0	1.2
D ( $\phi 6.3 \times L8.0$ )	0.95	0.65	1.0	1.2

When size "A" is wide, back fillet can be made, decreasing fitting strength.

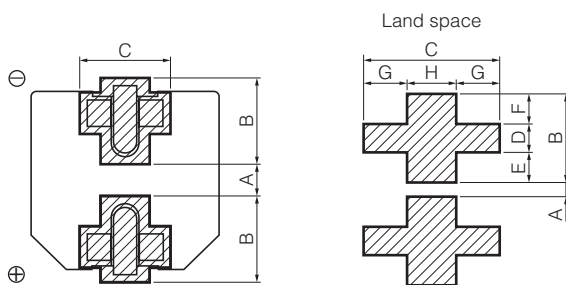

Size code	A	B	C	D
F ( $\phi 8 \times L10.5$ )	2.7	4.0	4.7	1.3
G ( $\phi 10 \times L10.5$ )	3.9	4.4	4.7	1.3

Size code	E	F	G	H
F ( $\phi 8 \times L10.5$ )	1.0	1.7	1.1	2.5
G ( $\phi 10 \times L10.5$ )	1.2	1.9	1.1	2.5

When size "A" is wide, back fillet can be made, decreasing fitting strength.

\* Take mounting conditions, solderability and fitting strength into consideration when selecting parts for your company's design.

## Packaging specifications

### Specifications for surface mount type

- Reel dimensions (not to scale)

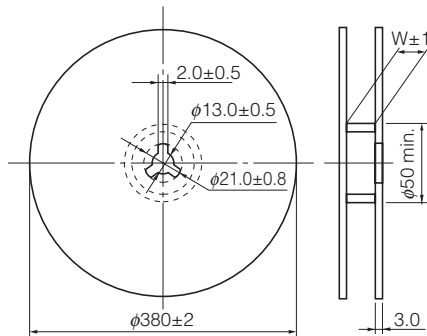

Unit : mm

Size code	W
C	14.0
D, D8	18.0
F, G	26.0

- Taping dimensions

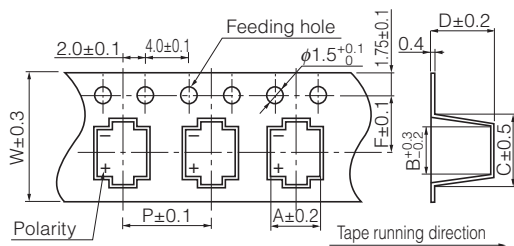

\* Ask factory for technical specifications.

### Specifications for radial lead type

- Packing Quantity

Size code	Quantity (pcs./Bag)	Quantity (pcs./Bag)
F ( $\phi 8 \times L 10.5$ )	200	4000
G ( $\phi 10 \times L 10.5$ )	200	2000

- Dimensions of outer carton box

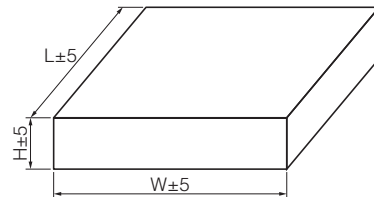

Unit : mm

Size code	H	W, L
C	220	395
D, D8	250	395
F, G	220	395

- Min.packing quantity

Size code	Min.packing q'ty pcs.
C, D	1000 pcs
D8	900 pcs
F, G	500 pcs

Unit : mm

Size code	A	B	C	D	P	F	W
C	5.7	5.7	8.0	6.4	12.0	5.5	12.0
D	7.0	7.0	9.0	6.4	12.0	7.5	16.0
D8	7.0	7.0	9.0	8.4	12.0	7.5	16.0
F	8.7	8.7	12.5	11.0	16.0	11.5	24.0
G	10.7	10.7	14.5	11.0	16.0	11.5	24.0

## Surface Mount Type

Series : **ZA** Type : **V**

**High temperature Lead-Free reflow**



### Features

- Endurance : 10000 h at 105 °C
- Low ESR and high ripple current (70 % over, Lower ESR than current V-FP)
- High voltage (to 80 V.DC)
- Equivalent to conductive polymer type aluminum electrolytic capacitor  
(There are little characteristics change by temperature and frequency)
- Vibration-proof product is available upon request. New lineup of  $\phi 6.3$  product. ( $\phi 6.3$  mm and larger)
- AEC-Q200 compliant
- RoHS compliant

### Specifications

Size code	C	D	D8	F	G															
Category temp. range	-55 °C to +105 °C																			
Rated voltage range	25 V.DC to 50 V.DC	25 V.DC to 63 V.DC		25 V.DC to 80 V.DC																
Nominal cap.range	10 $\mu$ F to 33 $\mu$ F	10 $\mu$ F to 56 $\mu$ F	22 $\mu$ F to 100 $\mu$ F	22 $\mu$ F to 220 $\mu$ F	33 $\mu$ F to 330 $\mu$ F															
Capacitance tolerance	$\pm 20$ % (120 Hz/+20 °C)																			
DC leakage current	$I \leq 0.01 CV$ or 3 ( $\mu$ A) After 2 minutes (whichever is greater)																			
Dissipation factor ( $\tan \delta$ )	Please see the attached standard products list																			
Endurance	105 °C, 10000 h, apply the rated ripple current without exceeding the rated voltage																			
	Capacitance change	Within $\pm 30$ % of the initial value																		
	$\tan \delta$	$\leq 200$ % of the initial limit																		
	E. S. R.	$\leq 200$ % of the initial limit																		
	DC leakage current	Within the initial limit																		
	ESR after Endurance ( $\Omega/100$ kHz) (-40 °C)	<table border="1"> <thead> <tr> <th colspan="5">Size code</th> </tr> <tr> <th>C</th> <th>D</th> <th>D8</th> <th>F</th> <th>G</th> </tr> </thead> <tbody> <tr> <td>2.0</td> <td>1.4</td> <td>0.8</td> <td>0.4</td> <td>0.3</td> </tr> </tbody> </table>					Size code					C	D	D8	F	G	2.0	1.4	0.8	0.4
Size code																				
C	D	D8	F	G																
2.0	1.4	0.8	0.4	0.3																
Shelf life	After storage for 1000 hours at +105 °C $\pm 2$ °C with no voltage applied and then being stabilized at +20 °C, capacitors shall meet the limits specified in Endurance. (With voltage treatment)																			
Damp heat (Load)	85 °C, 85 % to 90 %, 2000 h, rated voltage applied																			
	Capacitance change	Within $\pm 30$ % of the initial value																		
	$\tan \delta$	$\leq 200$ % of the initial limit																		
	E. S. R.	$\leq 200$ % of the initial limit																		
	DC leakage current	Within the initial limit																		
Resistance to soldering heat	After reflow soldering and then being stabilized at +20 °C, capacitors shall meet the following limits.																			
	Capacitance change	Within $\pm 10$ % of the initial value																		
	$\tan \delta$	Within the initial limit																		
	DC leakage current	Within the initial limit																		

### Marking

Example : 25 V.DC 33  $\mu$ F Marking color : BLACK

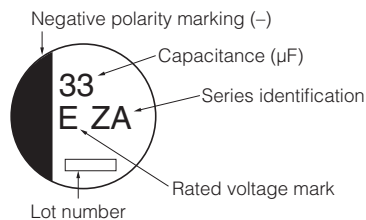

Rated voltage mark

E	25 V.DC	J	63 V.DC
V	35 V.DC	K	80 V.DC
H	50 V.DC		

### Dimensions (not to scale)

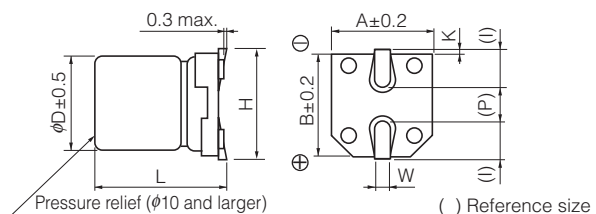

( ) Reference size

(Unit : mm)

Size code	D	L	A, B	H	I	W	P	K
C	5.0	5.8 $\pm 0.3$	5.3	6.5 max.	2.2	0.65 $\pm 0.1$	1.5	0.35 $\pm 0.15$
D	6.3	5.8 $\pm 0.3$	6.6	7.8 max.	2.6	0.65 $\pm 0.1$	1.8	0.35 $\pm 0.15$
D8	6.3	7.7 $\pm 0.3$	6.6	7.8 max.	2.6	0.65 $\pm 0.1$	1.8	0.35 $\pm 0.15$
F	8.0	10.2 $\pm 0.3$	8.3	10.0 max.	3.4	0.90 $\pm 0.2$	3.1	0.70 $\pm 0.2$
G	10.0	10.2 $\pm 0.3$	10.3	12.0 max.	3.5	0.90 $\pm 0.2$	4.6	0.70 $\pm 0.2$

The dimensions of the vibration-proof products, please refer to the page of the mounting specification.

## Standard products

Endurance : 105 °C 10000 h

Rated voltage (V.DC)	Capacitance (±20 %) (μF)	Case size (mm)		Size code	Specification			Part number		Min. packaging q'ty
		φD	L		Ripple current (100 kHz) (+105 °C) (mA r.m.s.)	E.S.R. (100 kHz) (+20 °C) (mΩ)	tan δ (120 Hz) (+20 °C)	Standard Product	Vibration-proof product	Taping (pcs)
25	33	5	5.8	C	900	80	0.14	EEHZA1E330R	—	1000
	56	6.3	5.8	D	1300	50	0.14	EEHZA1E560P	<b>NEW</b> EEHZA1E560V	1000
	100	6.3	7.7	D8	2000	30	0.14	EEHZA1E101XP	<b>NEW</b> EEHZA1E101XV	900
	220	8	10.2	F	2300	27	0.14	EEHZA1E221P	EEHZA1E221V	500
	330	10	10.2	G	2500	20	0.14	EEHZA1E331P	EEHZA1E331V	500
35	22	5	5.8	C	900	100	0.12	EEHZA1V220R	—	1000
	27	6.3	5.8	D	1300	60	0.12	EEHZA1V270P	<b>NEW</b> EEHZA1V270V	1000
	47	6.3	5.8	D	1300	60	0.12	EEHZA1V470P	<b>NEW</b> EEHZA1V470V	1000
	68	6.3	7.7	D8	2000	35	0.12	EEHZA1V680XP	<b>NEW</b> EEHZA1V680XV	900
	150	8	10.2	F	2300	27	0.12	EEHZA1V151P	EEHZA1V151V	500
	270	10	10.2	G	2500	20	0.12	EEHZA1V271P	EEHZA1V271V	500
50	10	5	5.8	C	750	120	0.10	EEHZA1H100R	—	1000
	22	6.3	5.8	D	1100	80	0.10	EEHZA1H220P	<b>NEW</b> EEHZA1H220V	1000
	33	6.3	7.7	D8	1600	40	0.10	EEHZA1H330XP	<b>NEW</b> EEHZA1H330XV	900
	68	8	10.2	F	1800	30	0.10	EEHZA1H680P	EEHZA1H680V	500
	100	10	10.2	G	2000	28	0.10	EEHZA1H101P	EEHZA1H101V	500
63	10	6.3	5.8	D	1000	120	0.08	EEHZA1J100P	<b>NEW</b> EEHZA1J100V	1000
	22	6.3	7.7	D8	1500	80	0.08	EEHZA1J220XP	<b>NEW</b> EEHZA1J220XV	900
	33	8	10.2	F	1700	40	0.08	EEHZA1J330P	EEHZA1J330V	500
	56	10	10.2	G	1800	30	0.08	EEHZA1J560P	EEHZA1J560V	500
80	22	8	10.2	F	1550	45	0.08	EEHZA1K220P	EEHZA1K220V	500
	33	10	10.2	G	1700	36	0.08	EEHZA1K330P	EEHZA1K330V	500

· Please refer to the page of "Reflow profile" and "The taping dimensions".

## Frequency correction factor for ripple current

Rated capacitance	Frequency	100 Hz ≤ f < 200 Hz	200 Hz ≤ f < 300 Hz	300 Hz ≤ f < 500 Hz	500 Hz ≤ f < 1 kHz
C < 47 μF	Correction factor	0.10	0.10	0.15	0.20
47 μF ≤ C < 150 μF		0.15	0.20	0.25	0.30
150 μF ≤ C		0.15	0.25	0.25	0.30
Rated capacitance	Frequency	1 kHz ≤ f < 2 kHz	2 kHz ≤ f < 3 kHz	3 kHz ≤ f < 5 kHz	5 kHz ≤ f < 10 kHz
C < 47 μF	Correction factor	0.30	0.40	0.45	0.50
47 μF ≤ C < 150 μF		0.40	0.45	0.55	0.60
150 μF ≤ C		0.45	0.50	0.60	0.65
Rated capacitance	Frequency	10 kHz ≤ f < 15 kHz	15 kHz ≤ f < 20 kHz	20 kHz ≤ f < 30 kHz	30 kHz ≤ f < 40 kHz
C < 47 μF	Correction factor	0.60	0.65	0.70	0.75
47 μF ≤ C < 150 μF		0.70	0.75	0.80	0.80
150 μF ≤ C		0.75	0.80	0.85	0.85
Rated capacitance	Frequency	40 kHz ≤ f < 50 kHz	50 kHz ≤ f < 100 kHz	100 kHz ≤ f < 500 kHz	500 kHz ≤ f
C < 47 μF	Correction factor	0.80	0.85	1.00	1.05
47 μF ≤ C < 150 μF		0.85	0.90	1.00	1.00
150 μF ≤ C		0.85	0.90	1.00	1.00

## Surface Mount Type

Series : **ZC** Type : **V**

**High temperature Lead-Free reflow**



### Features

- Endurance: 4000 h at 125 °C (High temperature / Long life)
- Low ESR and high ripple current (85 % over, Lower ESR than current V-TP)
- High-withstand voltage (25 V.DC to 80 V.DC), Low LC (0.01 CV or 3 μA)
- Equivalent to conductive polymer type aluminum electrolytic capacitor (There are little characteristics change by temperature and frequency)
- Vibration-proof product is available upon request. New lineup of φ6.3 product. (φ6.3 mm and larger)
- AEC-Q200 compliant
- RoHS directive compliant

### Specifications

Size code	C	D	D8	F	G
Category temp. range	-55 °C to +125 °C				
Rated voltage range	25 V.DC to 50 V.DC	25 V.DC to 63 V.DC		25 V.DC to 80 V.DC	
Nominal cap.range	10 μF to 33 μF	10 μF to 56 μF	22 μF to 100 μF	22 μF to 220 μF	33 μF to 330 μF
Capacitance tolerance	±20 % (120 Hz/+20 °C)				
DC leakage current	I ≤ 0.01 CV or 3 (μA) After 2 minutes (whichever is greater)				
Dissipation factor (tan δ)	Please see the attached standard products list				
Endurance 1	125 °C, 4000 h, apply the rated ripple current without exceeding the rated voltage				
	Capacitance change	Within ±30% of the initial value			
	tan δ	≤ 200 % of the initial limit			
	E. S. R.	≤ 200 % of the initial limit			
Endurance 2	125 °C, 3000 h, apply the rated ripple current without exceeding the rated voltage				
	Capacitance change	Within ±30% of the initial value			
	tan δ	≤ 200 % of the initial limit			
	E. S. R.	≤ 300 % of the initial limit			
Shelf life	After storage for 1000 hours at +125 °C±2 °C with no voltage applied and then being stabilized at +20 °C, capacitors shall meet the limits specified in Endurance. (With voltage treatment)				
	85 °C, 85 % to 90 %, 2000 h, rated voltage applied				
Damp heat (Load)	85 °C, 85 % to 90 %, 2000 h, rated voltage applied				
	Capacitance change	Within ±30% of the initial value			
	tan δ	≤ 200 % of the initial limit			
	E. S. R.	≤ 200 % of the initial limit			
Resistance to soldering heat	After reflow soldering and then being stabilized at +20 °C, capacitors shall meet the following limits.				
	Capacitance change	Within ±10% of the initial value			
	tan δ	Within the initial limit			
DC leakage current	Within the initial limit				

### Marking

Example : 25 V.DC 33 μF Marking color : BLACK

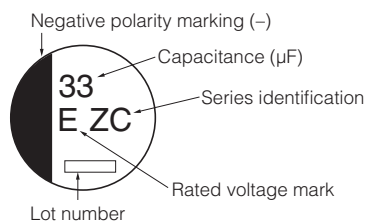

Rated voltage mark

E	25 V.DC	J	63 V.DC
V	35 V.DC	K	80 V.DC
H	50 V.DC		

### Dimensions (not to scale)

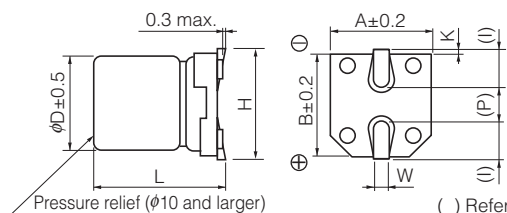

( ) Reference size (Unit : mm)

Size code	D	L	A, B	H	I	W	P	K
C	5.0	5.8±0.3	5.3	6.5 max.	2.2	0.65±0.1	1.5	0.35 <sup>+0.15</sup> <sub>-0.20</sub>
D	6.3	5.8±0.3	6.6	7.8 max.	2.6	0.65±0.1	1.8	0.35 <sup>+0.15</sup> <sub>-0.20</sub>
D8	6.3	7.7±0.3	6.6	7.8 max.	2.6	0.65±0.1	1.8	0.35 <sup>+0.15</sup> <sub>-0.20</sub>
F	8.0	10.2±0.3	8.3	10.0 max.	3.4	0.90±0.2	3.1	0.70±0.2
G	10.0	10.2±0.3	10.3	12.0 max.	3.5	0.90±0.2	4.6	0.70±0.2

· The dimensions of the vibration-proof products, please refer to the page of the mounting specification.



## Standard products

Endurance 1 : 125 °C 4000 h  
Endurance 2 : 125 °C 3000 h

Rated voltage (V.DC)	Capacitance (±20 %) (μF)	Case size (mm)		Size code	Specification				Part number		Min. packaging qty
		φD	L		Ripple current (100 kHz) (+125 °C) (mA r.m.s.)	ESR (100 kHz) (+20 °C) (mΩ)	tan δ (120 Hz) (+20 °C)	Standard Product	Vibration-proof product	Taping (pcs)	
											Endurance 1
25	33	5	5.8	C	550	–	80	0.14	EEHZC1E330R	–	1000
	56	6.3	5.8	D	900	–	50	0.14	EEHZC1E560P	NEW EEHZC1E560V	1000
	100	6.3	7.7	D8	1400	–	30	0.14	EEHZC1E101XP	NEW EEHZC1E101XV	900
	220	8	10.2	F	1600	1900	27	0.14	EEHZC1E221P	EEHZC1E221V	500
	330	10	10.2	G	2000	2900	20	0.14	EEHZC1E331P	EEHZC1E331V	500
35	22	5	5.8	C	550	–	100	0.12	EEHZC1V220R	–	1000
	47	6.3	5.8	D	900	–	60	0.12	EEHZC1V470P	NEW EEHZC1V470V	1000
	68	6.3	7.7	D8	1400	–	35	0.12	EEHZC1V680XP	NEW EEHZC1V680XV	900
	150	8	10.2	F	1600	1900	27	0.12	EEHZC1V151P	EEHZC1V151V	500
	270	10	10.2	G	2000	2800	20	0.12	EEHZC1V271P	EEHZC1V271V	500
50	10	5	5.8	C	500	–	120	0.10	EEHZC1H100R	–	1000
	22	6.3	5.8	D	750	–	80	0.10	EEHZC1H220P	NEW EEHZC1H220V	1000
	33	6.3	7.7	D8	1100	–	40	0.10	EEHZC1H330XP	NEW EEHZC1H330XV	900
	68	8	10.2	F	1250	–	30	0.10	EEHZC1H680P	EEHZC1H680V	500
	100	10	10.2	G	1600	–	28	0.10	EEHZC1H101P	EEHZC1H101V	500
	120	10	10.2	G	1600	–	28	0.10	EEHZC1H121P	EEHZC1H121V	500
63	10	6.3	5.8	D	700	–	120	0.08	EEHZC1J100P	NEW EEHZC1J100V	1000
	22	6.3	7.7	D8	900	–	80	0.08	EEHZC1J220XP	NEW EEHZC1J220XV	900
	33	8	10.2	F	1100	–	40	0.08	EEHZC1J330P	EEHZC1J330V	500
	56	10	10.2	G	1400	–	30	0.08	EEHZC1J560P	EEHZC1J560V	500
	NEW 68	10	10.2	G	1400	–	30	0.08	EEHZC1J680P	EEHZC1J680V	500
80	NEW 82	10	10.2	G	1400	–	30	0.08	EEHZC1J820P	EEHZC1J820V	500
	22	8	10.2	F	1050	–	45	0.08	EEHZC1K220P	EEHZC1K220V	500
	33	10	10.2	G	1360	–	36	0.08	EEHZC1K330P	EEHZC1K330V	500
	47	10	10.2	G	1360	–	36	0.08	EEHZC1K470P	EEHZC1K470V	500

· Please refer to the page of "Reflow profile" and "The taping dimensions".

## Frequency correction factor for ripple current

Rated capacitance	Frequency	100 Hz ≤ f < 200 Hz	200 Hz ≤ f < 300 Hz	300 Hz ≤ f < 500 Hz	500 Hz ≤ f < 1 kHz
C < 47 μF	Correction factor	0.10	0.10	0.15	0.20
47 μF ≤ C < 150 μF		0.15	0.20	0.25	0.30
150 μF ≤ C		0.15	0.25	0.25	0.30
Rated capacitance	Frequency	1 kHz ≤ f < 2 kHz	2 kHz ≤ f < 3 kHz	3 kHz ≤ f < 5 kHz	5 kHz ≤ f < 10 kHz
C < 47 μF	Correction factor	0.30	0.40	0.45	0.50
47 μF ≤ C < 150 μF		0.40	0.45	0.55	0.60
150 μF ≤ C		0.45	0.50	0.60	0.65
Rated capacitance	Frequency	10 kHz ≤ f < 15 kHz	15 kHz ≤ f < 20 kHz	20 kHz ≤ f < 30 kHz	30 kHz ≤ f < 40 kHz
C < 47 μF	Correction factor	0.60	0.65	0.70	0.75
47 μF ≤ C < 150 μF		0.70	0.75	0.80	0.80
150 μF ≤ C		0.75	0.80	0.85	0.85
Rated capacitance	Frequency	40 kHz ≤ f < 50 kHz	50 kHz ≤ f < 100 kHz	100 kHz ≤ f < 500 kHz	500 kHz ≤ f
C < 47 μF	Correction factor	0.80	0.85	1.00	1.05
47 μF ≤ C < 150 μF		0.85	0.90	1.00	1.00
150 μF ≤ C		0.85	0.90	1.00	1.00

## After endurance ESR (100 kHz, –40 °C)

Size	φ5×5.8	φ6.3×5.8	φ6.3×7.7	φ8×10.2	φ10×10.2
ESR (Ω)	2.0	1.4	0.8	0.4	0.3

Design and specifications are each subject to change without notice. Ask factory for the current technical specifications before purchase and/or use.  
Should a safety concern arise regarding this product, please be sure to contact us immediately.

## Surface Mount Type

Series : **ZK** Type : **V**

**High temperature Lead-Free reflow**



### Features

- High capacitance and High ripple current compared with ZC series
- Endurance : 4000 h at 125 °C (High temperature / Long life)
- Low ESR (85 % over, Lower ESR than Current V-TP), Low LC (0.01 CV or 3 μF)
- Equivalent to conductive polymer type Aluminum Electrolytic Capacitor  
(There are little characteristics change by temperature and frequency)
- Vibration-proof product is available upon request. New lineup of φ6.3 product. (φ6.3 mm and larger)
- AEC-Q200 compliant
- RoHS directive compliant

### Specifications

Size code	C	D	D8	F	G															
Category temp. range	-55 °C to +125 °C																			
Rated voltage range	25 V.DC to 35 V.DC																			
Nominal cap.range	33 μF to 47 μF	56 μF to 68 μF	100 μF to 150 μF	180 μF to 270 μF	330 μF to 470 μF															
Capacitance tolerance	±20 % (120 Hz/+20 °C)																			
DC leakage current	I ≤ 0.01 CV or 3 (μA) After 2 minutes (whichever is greater)																			
Dissipation factor (tan δ)	Please see the attached standard products list																			
Endurance	125 °C, 4000 h, apply the rated ripple current without exceeding the rated voltage																			
	Capacitance change	Within ±30% of the initial value																		
	tan δ	≤ 200 % of the initial limit																		
	E. S. R.	≤ 200 % of the initial limit																		
	DC leakage current	Within the initial limit																		
	ESR after Endurance (Ω/100 kHz) (-40 °C)	<table border="1"> <thead> <tr> <th colspan="5">Size code</th> </tr> <tr> <th>C</th> <th>D</th> <th>D8</th> <th>F</th> <th>G</th> </tr> </thead> <tbody> <tr> <td>2.0</td> <td>1.4</td> <td>0.8</td> <td>0.4</td> <td>0.3</td> </tr> </tbody> </table>					Size code					C	D	D8	F	G	2.0	1.4	0.8	0.4
Size code																				
C	D	D8	F	G																
2.0	1.4	0.8	0.4	0.3																
Shelf life	After storage for 1000 hours at +125 °C±2 °C with no voltage applied and then being stabilized at +20 °C, capacitors shall meet the limits specified in Endurance. (With voltage treatment)																			
Damp heat (Load)	85 °C, 85 % to 90 %, 2000 h, rated voltage applied																			
	Capacitance change	Within ±30 % of the initial value																		
	tan δ	≤ 200 % of the initial limit																		
	E. S. R.	≤ 200 % of the initial limit																		
	DC leakage current	Within the initial limit																		
Resistance to soldering heat	After reflow soldering and then being stabilized at +20 °C, capacitors shall meet the following limits.																			
	Capacitance change	Within ±10% of the initial value																		
	tan δ	Within the initial limit																		
	DC leakage current	Within the initial limit																		

### Marking

Example : 25 V.DC 47 μF Marking color : BLACK

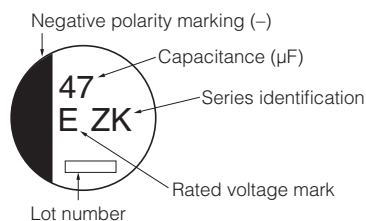

Rated voltage mark

E	25 V.DC
V	35 V.DC

### Dimensions (not to scale)

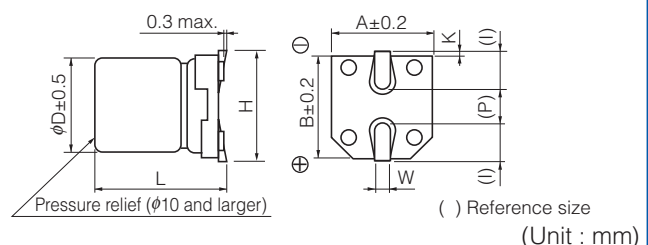

Size code	D	L	A, B	H	I	W	P	K
C	5.0	5.8±0.3	5.3	6.5 max.	2.2	0.65±0.1	1.5	0.35 <sup>+0.15</sup> <sub>-0.20</sub>
D	6.3	5.8±0.3	6.6	7.8 max.	2.6	0.65±0.1	1.8	0.35 <sup>+0.15</sup> <sub>-0.20</sub>
D8	6.3	7.7±0.3	6.6	7.8 max.	2.6	0.65±0.1	1.8	0.35 <sup>+0.15</sup> <sub>-0.20</sub>
F	8.0	10.2±0.3	8.3	10.0 max.	3.4	0.90±0.2	3.1	0.70±0.2
G	10.0	10.2±0.3	10.3	12.0 max.	3.5	0.90±0.2	4.6	0.70±0.2

The dimensions of the vibration-proof products, please refer to the page of the mounting specification.

## Standard products

Endurance : 125 °C 4000 h

Rated voltage (V.DC)	Capacitance (±20 %) (μF)	Case size (mm)		Size code	Specification			Part number		Min. packaging q'ty
		φD	L		Ripple current (100 kHz) (+125 °C) (mA r.m.s.)	E.S.R. (100 kHz) (+20 °C) (mΩ)	tan δ (120 Hz) (+20 °C)	Standard Product	Vibration-proof product	Taping (pcs)
25	47	5	5.8	C	660	80	0.14	EEHZK1E470R	–	1000
	68	6.3	5.8	D	1080	50	0.14	EEHZK1E680P	<sup>NEW</sup> EEHZK1E680V	1000
	150	6.3	7.7	D8	1680	30	0.14	EEHZK1E151XP	<sup>NEW</sup> EEHZK1E151XV	900
	270	8	10.2	F	1920	27	0.14	EEHZK1E271P	EEHZK1E271V	500
	470	10	10.2	G	2800	20	0.14	EEHZK1E471P	EEHZK1E471V	500
35	33	5	5.8	C	660	100	0.12	EEHZK1V330R	–	1000
	56	6.3	5.8	D	1080	60	0.12	EEHZK1V560P	<sup>NEW</sup> EEHZK1V560V	1000
	100	6.3	7.7	D8	1680	35	0.12	EEHZK1V101XP	<sup>NEW</sup> EEHZK1V101XV	900
	180	8	10.2	F	1920	27	0.12	EEHZK1V181P	EEHZK1V181V	500
	330	10	10.2	G	2800	20	0.12	EEHZK1V331P	EEHZK1V331V	500

· Please refer to the page of "Reflow profile" and "The taping dimensions".

## Frequency correction factor for ripple current

Rated capacitance	Frequency	100 Hz ≤ f < 200 Hz	200 Hz ≤ f < 300 Hz	300 Hz ≤ f < 500 Hz	500 Hz ≤ f < 1 kHz
C < 47 μF	Correction factor	0.10	0.10	0.15	0.20
47 μF ≤ C < 150 μF		0.15	0.20	0.25	0.30
150 μF ≤ C		0.15	0.25	0.25	0.30
Rated capacitance	Frequency	1 kHz ≤ f < 2 kHz	2 kHz ≤ f < 3 kHz	3 kHz ≤ f < 5 kHz	5 kHz ≤ f < 10 kHz
C < 47 μF	Correction factor	0.30	0.40	0.45	0.50
47 μF ≤ C < 150 μF		0.40	0.45	0.55	0.60
150 μF ≤ C		0.45	0.50	0.60	0.65
Rated capacitance	Frequency	10 kHz ≤ f < 15 kHz	15 kHz ≤ f < 20 kHz	20 kHz ≤ f < 30 kHz	30 kHz ≤ f < 40 kHz
C < 47 μF	Correction factor	0.60	0.65	0.70	0.75
47 μF ≤ C < 150 μF		0.70	0.75	0.80	0.80
150 μF ≤ C		0.75	0.80	0.85	0.85
Rated capacitance	Frequency	40 kHz ≤ f < 50 kHz	50 kHz ≤ f < 100 kHz	100 kHz ≤ f < 500 kHz	500 kHz ≤ f
C < 47 μF	Correction factor	0.80	0.85	1.00	1.05
47 μF ≤ C < 150 μF		0.85	0.90	1.00	1.00
150 μF ≤ C		0.85	0.90	1.00	1.00

## Surface Mount Type

Series : **ZE** Type : **V**

**High temperature Lead-Free reflow**



### Features

- Endurance: 2000 h at 145 °C (High temperature / Long life)
- Low ESR and high ripple current (85 % over, Lower ESR than current V-TP)
- High-withstand voltage (25 V.DC to 63 V.DC), Low LC (0.01 CV or 3 μA)
- Equivalent to conductive polymer type aluminum electrolytic capacitor (There are little characteristics change by temperature and frequency)
- Vibration-proof product is available upon request. (φ8 mm and larger)
- AEC-Q200 compliant
- RoHS directive compliant

### Specifications

Size code	F	G
Category temp. range	-55 °C to +145 °C	
Rated voltage range	25 V.DC to 63 V.DC	
Nominal cap.range	33 μF to 220 μF	56 μF to 330 μF
Capacitance tolerance	±20 % (120 Hz/+20 °C)	
DC leakage current	I ≤ 0.01 CV or 3 (μA) After 2 minutes (whichever is greater)	
Dissipation factor (tan δ)	Please see the attached standard products list	
Endurance 1	145 °C, 2000 h, apply the rated ripple current without exceeding the rated voltage	
	Capacitance change	Within ±30% of the initial value
	tan δ	≤ 200 % of the initial limit
	E. S. R.	≤ 200 % of the initial limit
Endurance 2	135 °C, 4000 h, apply the rated ripple current without exceeding the rated voltage	
	Capacitance change	Within ±30% of the initial value
	tan δ	≤ 200 % of the initial limit
	E. S. R.	≤ 200 % of the initial limit
Shelf life	After storage for 1000 hours at +145 °C±2 °C with no voltage applied and then being stabilized at +20 °C, capacitors shall meet the limits specified in Endurance. (With voltage treatment)	
	85 °C, 85 % to 90 %, 2000 h, rated voltage applied	
Damp heat (Load)	85 °C, 85 % to 90 %, 2000 h, rated voltage applied	
	Capacitance change	Within ±30% of the initial value
	tan δ	≤ 200 % of the initial limit
	E. S. R.	≤ 200 % of the initial limit
Resistance to soldering heat	After reflow soldering and then being stabilized at +20 °C, capacitors shall meet the following limits.	
	Capacitance change	Within ±10% of the initial value
	tan δ	Within the initial limit
	DC leakage current	Within the initial limit

### Marking

Example : 25 V.DC 220 μF Marking color : BLACK

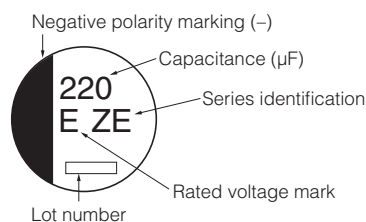

Rated voltage mark

E	25 V.DC	H	50 V.DC
V	35 V.DC	J	63 V.DC

### Dimensions (not to scale)

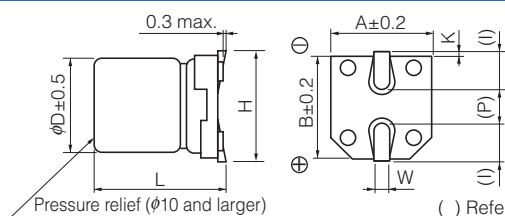

( ) Reference size

(Unit : mm)

Size code	D	L	A, B	H	I	W	P	K
F	8.0	10.2±0.3	8.3	10.0 max.	3.4	0.90±0.2	3.1	0.70±0.2
G	10.0	10.2±0.3	10.3	12.0 max.	3.5	0.90±0.2	4.6	0.70±0.2

· The dimensions of the vibration-proof products, please refer to the page of the mounting specification.

## Standard products

Endurance 1 : 145 °C 2000 h  
Endurance 2 : 135 °C 4000 h

Rated voltage (V.DC)	Capacitance (±20 %) (μF)	Case size (mm)		Size code	Specification				Part number		Min. packaging q'ty
		φD	L		Ripple current (100 kHz) (mA r.m.s.)		ESR (100 kHz) (+20 °C) (mΩ)	tan δ (120 Hz) (+20 °C)	Standard Product	Vibration-proof product	
					Endurance 1 (+145 °C)	Endurance 2 (+135 °C)					Taping (pcs)
25	220	8	10.2	F	700	1600	27	0.14	EEHZE1E221P	EEHZE1E221V	500
	330	10	10.2	G	900	2000	20	0.14	EEHZE1E331P	EEHZE1E331V	500
35	150	8	10.2	F	700	1600	27	0.12	EEHZE1V151P	EEHZE1V151V	500
	270	10	10.2	G	900	2000	20	0.12	EEHZE1V271P	EEHZE1V271V	500
50	68	8	10.2	F	600	1250	30	0.10	EEHZE1H680P	EEHZE1H680V	500
	100	10	10.2	G	800	1600	28	0.10	EEHZE1H101P	EEHZE1H101V	500
63	33	8	10.2	F	600	1100	40	0.08	EEHZE1J330P	EEHZE1J330V	500
	56	10	10.2	G	800	1400	30	0.08	EEHZE1J560P	EEHZE1J560V	500

· Please refer to the page of "Reflow profile" and "The taping dimensions".

## Frequency correction factor for ripple current

Rated capacitance	Frequency	100 Hz ≤ f < 200 Hz	200 Hz ≤ f < 300 Hz	300 Hz ≤ f < 500 Hz	500 Hz ≤ f < 1 kHz
C < 47 μF	Correction factor	0.10	0.10	0.15	0.20
47 μF ≤ C < 150 μF		0.15	0.20	0.25	0.30
150 μF ≤ C		0.15	0.25	0.25	0.30
Rated capacitance	Frequency	1 kHz ≤ f < 2 kHz	2 kHz ≤ f < 3 kHz	3 kHz ≤ f < 5 kHz	5 kHz ≤ f < 10 kHz
C < 47 μF	Correction factor	0.30	0.40	0.45	0.50
47 μF ≤ C < 150 μF		0.40	0.45	0.55	0.60
150 μF ≤ C		0.45	0.50	0.60	0.65
Rated capacitance	Frequency	10 kHz ≤ f < 15 kHz	15 kHz ≤ f < 20 kHz	20 kHz ≤ f < 30 kHz	30 kHz ≤ f < 40 kHz
C < 47 μF	Correction factor	0.60	0.65	0.70	0.75
47 μF ≤ C < 150 μF		0.70	0.75	0.80	0.80
150 μF ≤ C		0.75	0.80	0.85	0.85
Rated capacitance	Frequency	40 kHz ≤ f < 50 kHz	50 kHz ≤ f < 100 kHz	100 kHz ≤ f < 500 kHz	500 kHz ≤ f
C < 47 μF	Correction factor	0.80	0.85	1.00	1.05
47 μF ≤ C < 150 μF		0.85	0.90	1.00	1.00
150 μF ≤ C		0.85	0.90	1.00	1.00

## After endurance ESR (100 kHz, -40 °C)

Size	φ8×10.2	φ10×10.2
ESR (Ω)	0.4	0.3

## Radial Lead Type

Series : **ZF** Type : **A**

**NEW**



### Features

- Endurance : 1000 h at 150 °C (High temperature)
- High temperature compared with ZC series
- High-withstand voltage (25 V to 63 V), Low LC (0.01 CV or 3 μF)
- Equivalent to conductive polymer type Aluminum Electrolytic Capacitor (There are little characteristics change by temperature and frequency)
- AEC-Q200 compliant
- RoHS compliant

### Specifications

Size code	F	G
Category temp. range	-55 °C to +150 °C	
Rated voltage range	25 V.DC to 63 V.DC	
Nominal cap.range	33 μF to 150 μF	56 μF to 270 μF
Capacitance tolerance	±20 % (120 Hz/+20 °C)	
DC leakage current	I ≤ 0.01 CV or 3 (μA) After 2 minutes (whichever is greater)	
Dissipation factor (tan δ)	Please see the attached standard products list	
Endurance	+150 °C±2 °C, 1000 h, apply the rated ripple current without exceeding the rated voltage	
	Capacitance change	Within ±30% of the initial value
	tan δ	≤ 200 % of the initial limit
	E. S. R.	≤ 200 % of the initial limit
	DC leakage current	Within the initial limit
	ESR after Endurance (Ω/100 kHz) (-40 °C)	Size code
F		G
Shelf life	After storage for 1000 hours at +150 °C±2 °C with no voltage applied and then being stabilized at +20 °C, capacitors shall meet the limits specified in Endurance. (With voltage treatment)	
	+85 °C±2 °C, 85 % to 90 %, 2000 h, rated voltage applied	
Damp heat (Load)	Capacitance change	Within ±30% of the initial value
	tan δ	≤ 200 % of the initial limit
	E. S. R.	≤ 200 % of the initial limit
	DC leakage current	Within the initial limit

### Marking

Example : 25 V.DC 270 μF

Marking color : BLACK

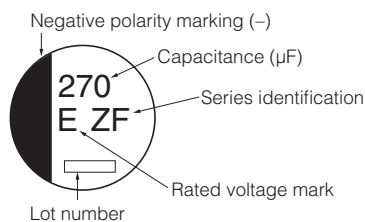

Rated voltage mark

E	25 V.DC	H	50 V.DC
V	35 V.DC	J	63 V.DC

### Dimensions (not to scale)

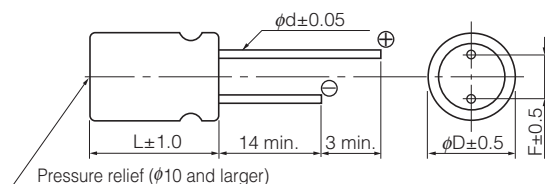

(Unit : mm)

Size code	φD	L	φd	F
F	8.0	9.5	0.6	3.5
G	10.0	9.5	0.6	5.0



## Standard products

Endurance : 150 °C 1000 h

Rated voltage (V.DC)	Capacitance (±20 %) (μF)	Case size (mm)		Size code	Specification			Part number	Min. packaging q'ty
		φD	L		Ripple current (100 kHz) (+150 °C) (mA r.m.s.)	E.S.R. (100 kHz) (+20 °C) (mΩ)	tan δ (120 Hz) (+20 °C)		Long lead (pcs)
25	150	8	9.5	F	800	27	0.14	EEHAZF1E151	200
	270	10	9.5	G	1000	20	0.14	EEHAZF1E271	200
35	100	8	9.5	F	770	30	0.12	EEHAZF1V101	200
	150	10	9.5	G	950	23	0.12	EEHAZF1V151	200
50	56	8	9.5	F	700	35	0.10	EEHAZF1H560	200
	100	10	9.5	G	900	28	0.10	EEHAZF1H101	200
63	33	8	9.5	F	650	40	0.08	EEHAZF1J330	200
	56	10	9.5	G	840	30	0.08	EEHAZF1J560	200

## Frequency correction factor for ripple current

Rated capacitance	Frequency	100 Hz ≤ f < 200 Hz	200 Hz ≤ f < 300 Hz	300 Hz ≤ f < 500 Hz	500 Hz ≤ f < 1 kHz
C < 47 μF	Correction factor	0.10	0.10	0.15	0.20
47 μF ≤ C < 150 μF		0.15	0.20	0.25	0.30
150 μF ≤ C		0.15	0.25	0.25	0.30
Rated capacitance	Frequency	1 kHz ≤ f < 2 kHz	2 kHz ≤ f < 3 kHz	3 kHz ≤ f < 5 kHz	5 kHz ≤ f < 10 kHz
C < 47 μF	Correction factor	0.30	0.40	0.45	0.50
47 μF ≤ C < 150 μF		0.40	0.45	0.55	0.60
150 μF ≤ C		0.45	0.50	0.60	0.65
Rated capacitance	Frequency	10 kHz ≤ f < 15 kHz	15 kHz ≤ f < 20 kHz	20 kHz ≤ f < 30 kHz	30 kHz ≤ f < 40 kHz
C < 47 μF	Correction factor	0.60	0.65	0.70	0.75
47 μF ≤ C < 150 μF		0.70	0.75	0.80	0.80
150 μF ≤ C		0.75	0.80	0.85	0.85
Rated capacitance	Frequency	40 kHz ≤ f < 50 kHz	50 kHz ≤ f < 100 kHz	100 kHz ≤ f < 500 kHz	500 kHz ≤ f
C < 47 μF	Correction factor	0.80	0.85	1.00	1.05
47 μF ≤ C < 150 μF		0.85	0.90	1.00	1.00
150 μF ≤ C		0.85	0.90	1.00	1.00

### CAUTION AND WARNING

1. The electronic components contained in this catalog are designed and produced for use in home electric appliances, office equipment, information equipment, communications equipment, and other general purpose electronic devices.  
Before use of any of these components for equipment that requires a high degree of safety, such as medical instruments, aerospace equipment, disaster-prevention equipment, security equipment, vehicles (automobile, train, vessel), please be sure to contact our sales representative corporation.
2. When applying one of these components for equipment requiring a high degree of safety, no matter what sort of application it might be, be sure to install a protective circuit or redundancy arrangement to enhance the safety of your equipment. In addition, please carry out the safety test on your own responsibility.
3. When using our products, no matter what sort of equipment they might be used for, be sure to make a written agreement on the specifications with us in advance.
4. Technical information contained in this catalog is intended to convey examples of typical performances and or applications and is not intended to make any warranty with respect to the intellectual property rights or any other related rights of our company or any third parties nor grant any license under such rights.
5. In order to export products in this catalog, the exporter may be subject to the export license requirement under the Foreign Exchange and Foreign Trade Law of Japan.
6. No ozone-depleting substances (ODSs) under the Montreal Protocol are used in the manufacturing processes of Automotive & Industrial Systems Company, Panasonic Corporation.

● Please contact \_\_\_\_\_

● Factory \_\_\_\_\_

Device Solutions Business Division  
Automotive & Industrial Systems Company

**Panasonic**<sup>®</sup>

1006 Kadoma, Kadoma City, Osaka 571-8506,  
JAPAN

The information in this catalog is valid as of June 2018.