



TS4871

OUTPUT RAIL TO RAIL 1W AUDIO POWER AMPLIFIER WITH STANDBY MODE

- OPERATING FROM $V_{CC} = 2.5V$ to $5.5V$
- **1W** RAIL TO RAIL OUTPUT POWER @ $V_{CC}=5V$, THD=1%, $f=1kHz$, with 8Ω Load
- ULTRA LOW CONSUMPTION IN STANDBY MODE (**10nA**)
- **75dB** PSRR @ 217Hz from 5V to 2.6V
- ULTRA LOW POP & CLICK
- ULTRA LOW DISTORTION (**0.1%**)
- UNITY GAIN STABLE
- AVAILABLE IN **SO8**, **MiniSO8** & **DFN8** 3x3mm

DESCRIPTION

The TS4871 is an Audio Power Amplifier capable of delivering 1W of continuous RMS Output Power into 8Ω load @ 5V.

This Audio Amplifier is exhibiting 0.1% distortion level (THD) from a 5V supply for a $P_{out} = 250mW$ RMS. An external standby mode control reduces the supply current to less than 10nA. An internal thermal shutdown protection is also provided.

The TS4871 has been designed for high quality audio applications such as mobile phones and to minimize the number of external components.

The unity-gain stable amplifier can be configured by external gain setting resistors.

APPLICATIONS

- Mobile Phones (Cellular / Cordless)
- Laptop / Notebook Computers
- PDAs
- Portable Audio Devices

ORDER CODE

| Part Number | Temperature Range: I | Package | | | Marking |
|-------------|----------------------|---------|---|---|---------|
| | | D | S | Q | |
| TS4871 | -40, +85°C | • | | | 4871I |
| | | | • | • | 4871 |

MiniSO & DFN only available in Tape & Reel with T suffix (IST & IQT)
D = Small Outline Package (SO) - also available in Tape & Reel (DT)

June 2003

PIN CONNECTIONS (Top View)

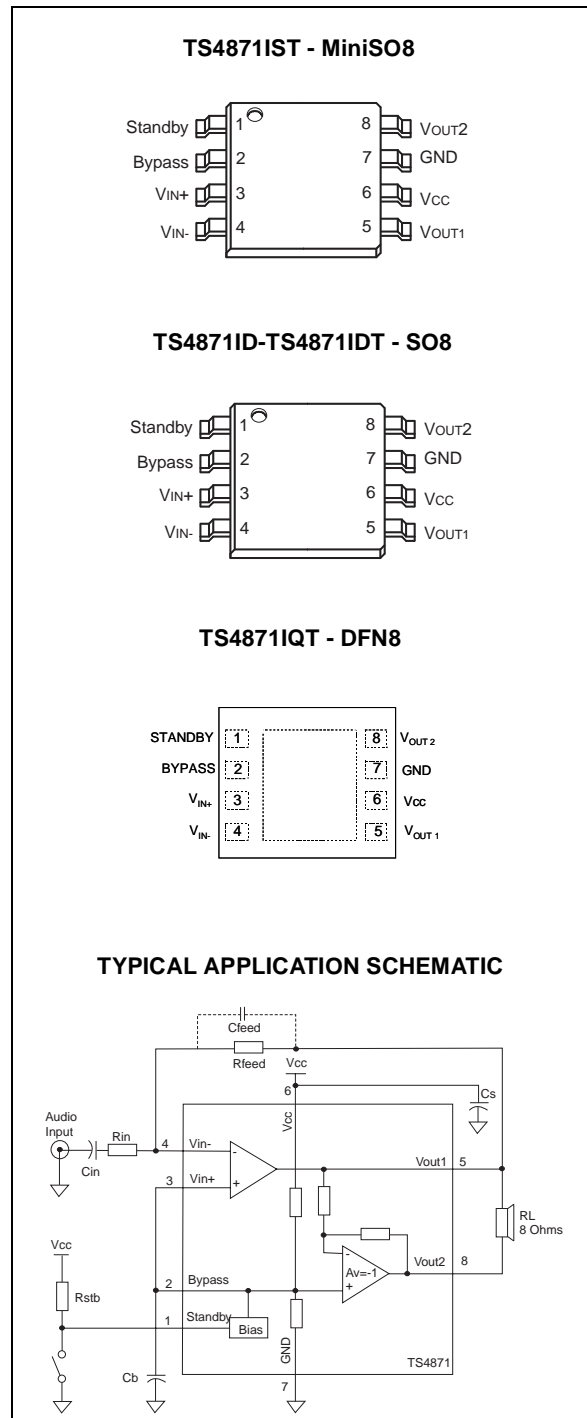

ABSOLUTE MAXIMUM RATINGS

| Symbol | Parameter | Value | Unit |
|------------|--|----------------------------------|------|
| V_{CC} | Supply voltage ¹⁾ | 6 | V |
| V_i | Input Voltage ²⁾ | G_{ND} to V_{CC} | V |
| T_{oper} | Operating Free Air Temperature Range | -40 to + 85 | °C |
| T_{stg} | Storage Temperature | -65 to +150 | °C |
| T_j | Maximum Junction Temperature | 150 | °C |
| R_{thja} | Thermal Resistance Junction to Ambient ³⁾ SO8 MiniSO8 QNF8 | 175 215 70 | °C/W |
| P_d | Power Dissipation | Internally Limited ⁴⁾ | |
| ESD | Human Body Model | 2 | kV |
| ESD | Machine Model | 200 | V |
| Latch-up | Latch-up Immunity | Class A | |
| | Lead Temperature (soldering, 10sec) | 260 | °C |

1. All voltages values are measured with respect to the ground pin.

2. The magnitude of input signal must never exceed $V_{CC} + 0.3V / G_{ND} - 0.3V$

3. Device is protected in case of over temperature by a thermal shutdown active @ 150°C.

4. Exceeding the power derating curves during a long period, involves abnormal operating condition.

OPERATING CONDITIONS

| Symbol | Parameter | Value | Unit |
|------------|--|---|----------|
| V_{CC} | Supply Voltage | 2.5 to 5.5 | V |
| V_{ICM} | Common Mode Input Voltage Range | G_{ND} to $V_{CC} - 1.2V$ | V |
| V_{STB} | Standby Voltage Input : Device ON Device OFF | $G_{ND} \leq V_{STB} \leq 0.5V$ $V_{CC} - 0.5V \leq V_{STB} \leq V_{CC}$ | V |
| R_L | Load Resistor | 4 - 32 | Ω |
| R_{thja} | Thermal Resistance Junction to Ambient ¹⁾ SO8 MiniSO8 DFN8 ²⁾ | 150 190 41 | °C/W |

1. This thermal resistance can be reduced with a suitable PCB layout (see Power Derating Curves Fig. 20)

2. When mounted on a 4 layers PCB

ELECTRICAL CHARACTERISTICS $V_{CC} = +5V$, $GND = 0V$, $T_{amb} = 25^{\circ}C$ (unless otherwise specified)

| Symbol | Parameter | Min. | Typ. | Max. | Unit |
|---------------|---|------|------|------|---------|
| I_{CC} | Supply Current No input signal, no load | | 6 | 8 | mA |
| $I_{STANDBY}$ | Standby Current ¹⁾ No input signal, $V_{stdby} = V_{CC}$, $R_L = 8\Omega$ | | 10 | 1000 | nA |
| V_{OO} | Output Offset Voltage No input signal, $R_L = 8\Omega$ | | 5 | 20 | mV |
| P_o | Output Power THD = 1% Max, $f = 1kHz$, $R_L = 8\Omega$ | | 1 | | W |
| THD + N | Total Harmonic Distortion + Noise $P_o = 250mW$ rms, $G_v = 2$, $20Hz < f < 20kHz$, $R_L = 8\Omega$ | | 0.15 | | % |
| PSRR | Power Supply Rejection Ratio ²⁾ $f = 217Hz$, $R_L = 8\Omega$, $R_{Feed} = 22K\Omega$, $V_{ripple} = 200mV$ rms | | 75 | | dB |
| Φ_M | Phase Margin at Unity Gain $R_L = 8\Omega$, $C_L = 500pF$ | | 70 | | Degrees |
| GM | Gain Margin $R_L = 8\Omega$, $C_L = 500pF$ | | 20 | | dB |
| GBP | Gain Bandwidth Product $R_L = 8\Omega$ | | 2 | | MHz |

1. Standby mode is activated when V_{stdby} is tied to V_{CC} 2. Dynamic measurements - $20 \cdot \log(\text{rms}(V_{out})/\text{rms}(V_{ripple}))$. Vripple is the surimposed sinus signal to V_{CC} @ $f = 217Hz$ $V_{CC} = +3.3V$, $GND = 0V$, $T_{amb} = 25^{\circ}C$ (unless otherwise specified)³⁾

| Symbol | Parameter | Min. | Typ. | Max. | Unit |
|---------------|---|------|------|------|---------|
| I_{CC} | Supply Current No input signal, no load | | 5.5 | 8 | mA |
| $I_{STANDBY}$ | Standby Current ¹⁾ No input signal, $V_{stdby} = V_{CC}$, $R_L = 8\Omega$ | | 10 | 1000 | nA |
| V_{OO} | Output Offset Voltage No input signal, $R_L = 8\Omega$ | | 5 | 20 | mV |
| P_o | Output Power THD = 1% Max, $f = 1kHz$, $R_L = 8\Omega$ | | 450 | | mW |
| THD + N | Total Harmonic Distortion + Noise $P_o = 250mW$ rms, $G_v = 2$, $20Hz < f < 20kHz$, $R_L = 8\Omega$ | | 0.15 | | % |
| PSRR | Power Supply Rejection Ratio ²⁾ $f = 217Hz$, $R_L = 8\Omega$, $R_{Feed} = 22K\Omega$, $V_{ripple} = 200mV$ rms | | 75 | | dB |
| Φ_M | Phase Margin at Unity Gain $R_L = 8\Omega$, $C_L = 500pF$ | | 70 | | Degrees |
| GM | Gain Margin $R_L = 8\Omega$, $C_L = 500pF$ | | 20 | | dB |
| GBP | Gain Bandwidth Product $R_L = 8\Omega$ | | 2 | | MHz |

1. Standby mode is activated when V_{stdby} is tied to V_{CC} 2. Dynamic measurements - $20 \cdot \log(\text{rms}(V_{out})/\text{rms}(V_{ripple}))$. Vripple is the surimposed sinus signal to V_{CC} @ $f = 217Hz$

3. All electrical values are made by correlation between 2.6V and 5V measurements

ELECTRICAL CHARACTERISTICS

V_{CC} = 2.6V, GND = 0V, T_{amb} = 25°C (unless otherwise specified)

| Symbol | Parameter | Min. | Typ. | Max. | Unit |
|----------------------|---|------|------|------|---------|
| I _{CC} | Supply Current No input signal, no load | | 5.5 | 8 | mA |
| I _{STANDBY} | Standby Current ¹⁾ No input signal, V _{stdby} = V _{cc} , R _L = 8Ω | | 10 | 1000 | nA |
| V _{OO} | Output Offset Voltage No input signal, R _L = 8Ω | | 5 | 20 | mV |
| P _O | Output Power THD = 1% Max, f = 1kHz, R _L = 8Ω | | 260 | | mW |
| THD + N | Total Harmonic Distortion + Noise P _O = 200mW rms, G _v = 2, 20Hz < f < 20kHz, R _L = 8Ω | | 0.15 | | % |
| PSRR | Power Supply Rejection Ratio ²⁾ f = 217Hz, R _L = 8Ω, R _{Feed} = 22KΩ, V _{ripple} = 200mV rms | | 75 | | dB |
| Φ _M | Phase Margin at Unity Gain R _L = 8Ω, C _L = 500pF | | 70 | | Degrees |
| GM | Gain Margin R _L = 8Ω, C _L = 500pF | | 20 | | dB |
| GBP | Gain Bandwidth Product R _L = 8Ω | | 2 | | MHz |

1. Standby mode is activated when V_{stdby} is tied to V_{cc}

2. Dynamic measurements - 20*log(rms(V_{out})/rms(V_{ripple})). V_{ripple} is the surimposed sinus signal to V_{cc} @ f = 217Hz

| Components | Functional Description |
|-------------------|--|
| R _{in} | Inverting input resistor which sets the closed loop gain in conjunction with R _{feed} . This resistor also forms a high pass filter with C _{in} (f _c = 1 / (2 x Pi x R _{in} x C _{in})) |
| C _{in} | Input coupling capacitor which blocks the DC voltage at the amplifier input terminal |
| R _{feed} | Feed back resistor which sets the closed loop gain in conjunction with R _{in} |
| C _s | Supply Bypass capacitor which provides power supply filtering |
| C _b | Bypass pin capacitor which provides half supply filtering |
| C _{feed} | Low pass filter capacitor allowing to cut the high frequency (low pass filter cut-off frequency 1 / (2 x Pi x R _{feed} x C _{feed})) |
| R _{stb} | Pull-up resistor which fixes the right supply level on the standby pin |
| G _v | Closed loop gain in BTL configuration = 2 x (R _{feed} / R _{in}) |

REMARKS

1. All measurements, except PSRR measurements, are made with a supply bypass capacitor C_s = 100μF.
2. External resistors are not needed for having better stability when supply @ V_{cc} down to 3V. By the way, the quiescent current remains the same.
3. The standby response time is about 1μs.

Fig. 1 : Open Loop Frequency Response

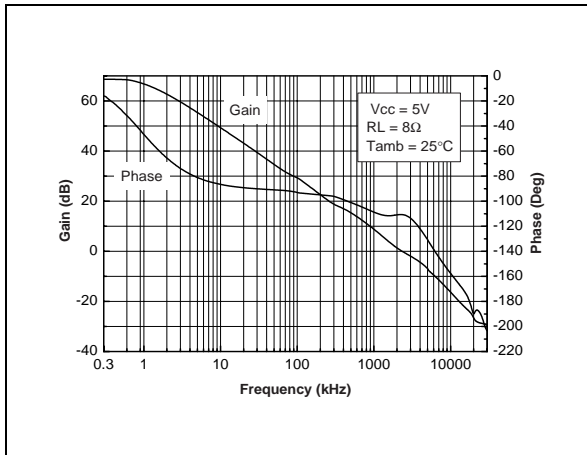

Fig. 2 : Open Loop Frequency Response

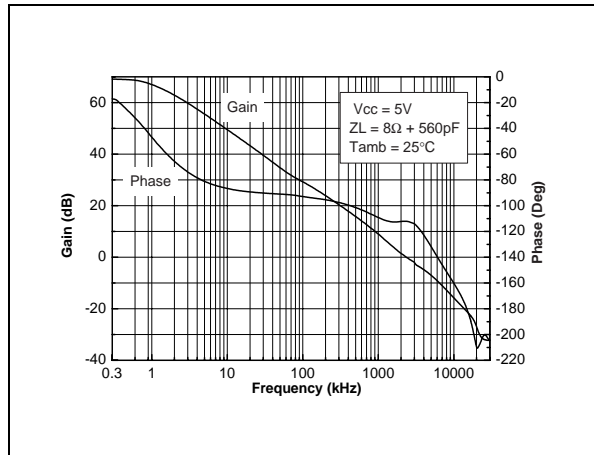

Fig. 3 : Open Loop Frequency Response

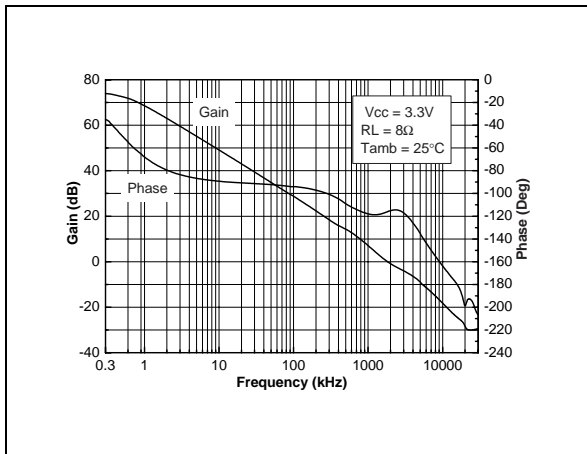

Fig. 4 : Open Loop Frequency Response

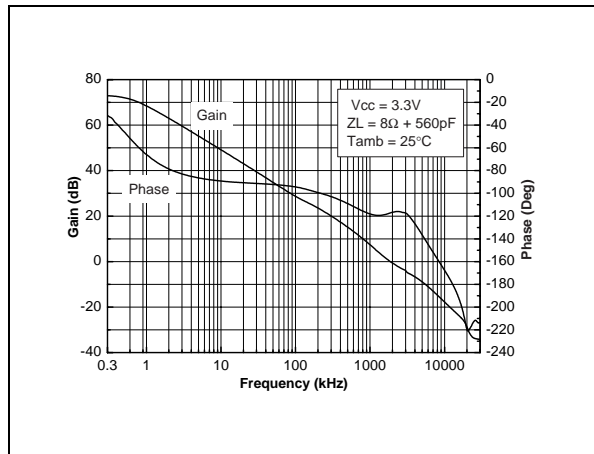

Fig. 5 : Open Loop Frequency Response

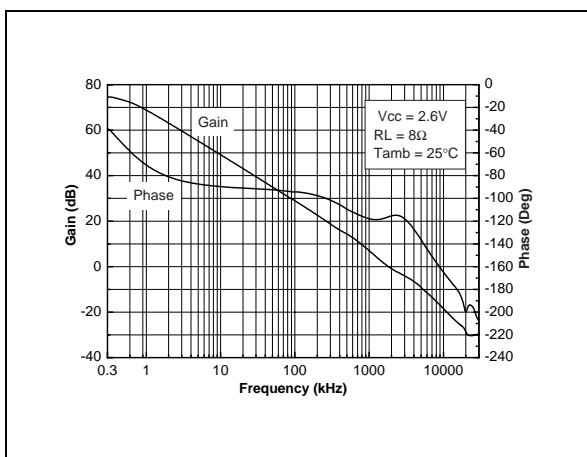

Fig. 6 : Open Loop Frequency Response

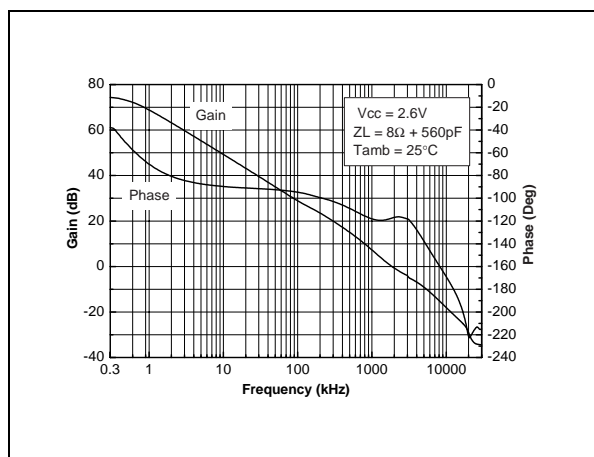

Fig. 7 : Open Loop Frequency Response

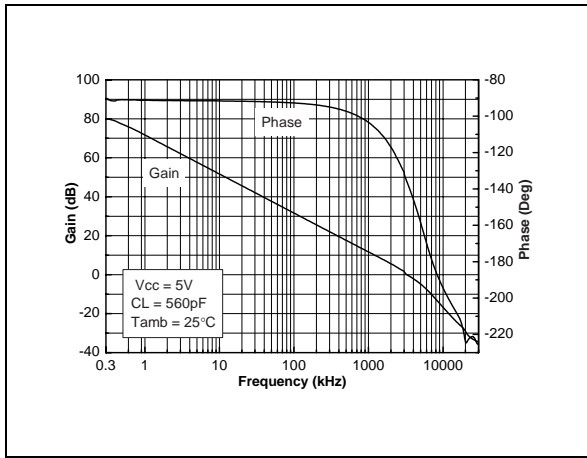

Fig. 8 : Open Loop Frequency Response

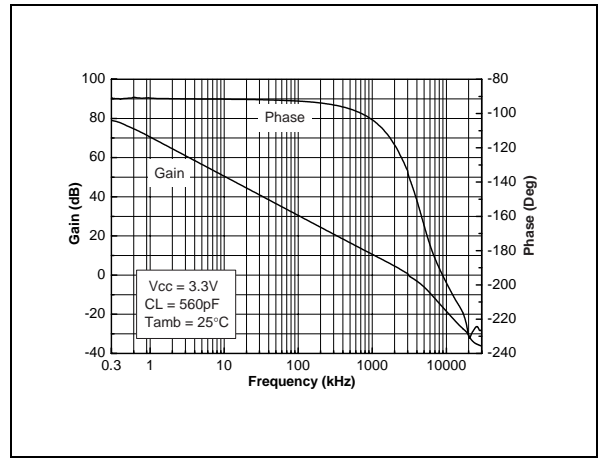

Fig. 9 : Open Loop Frequency Response

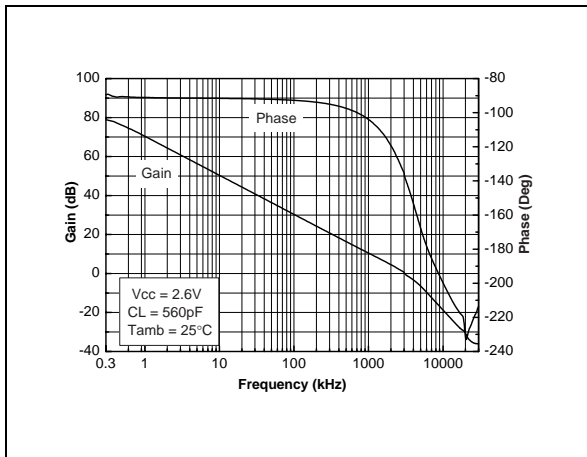

Fig. 10 : Power Supply Rejection Ratio (PSRR) vs Power supply

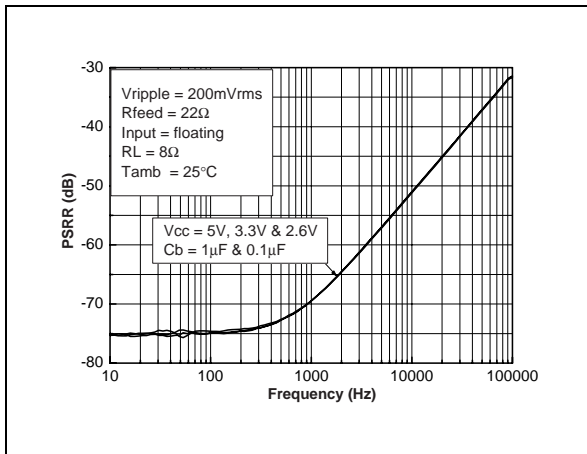

Fig. 11 : Power Supply Rejection Ratio (PSRR) vs Feedback Capacitor

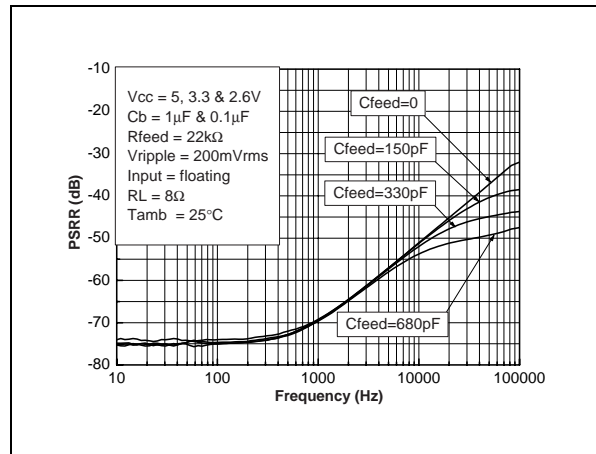

Fig. 12 : Power Supply Rejection Ratio (PSRR) vs Bypass Capacitor

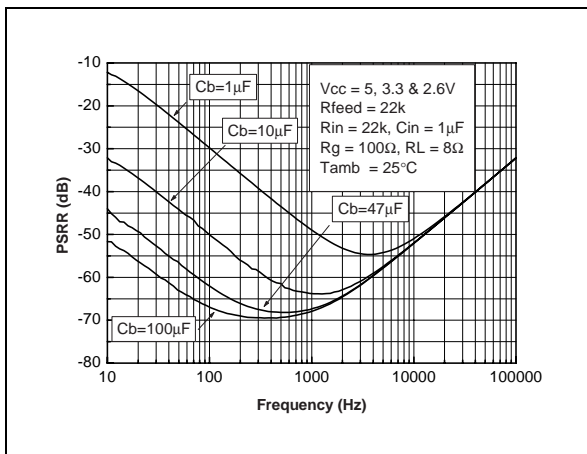

Fig. 13 : Power Supply Rejection Ratio (PSRR) vs Input Capacitor

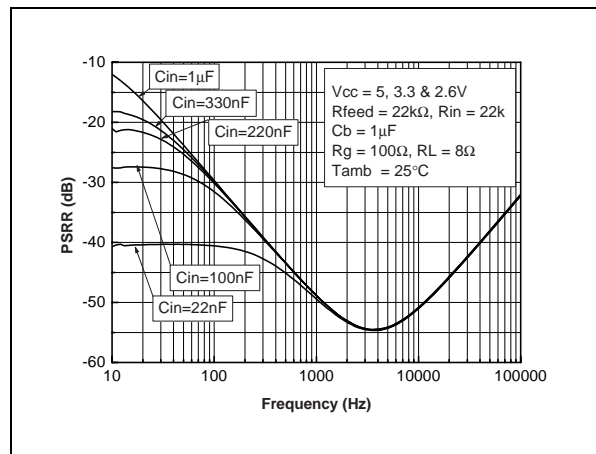

Fig. 14 : Power Supply Rejection Ratio (PSRR) vs Feedback Resistor

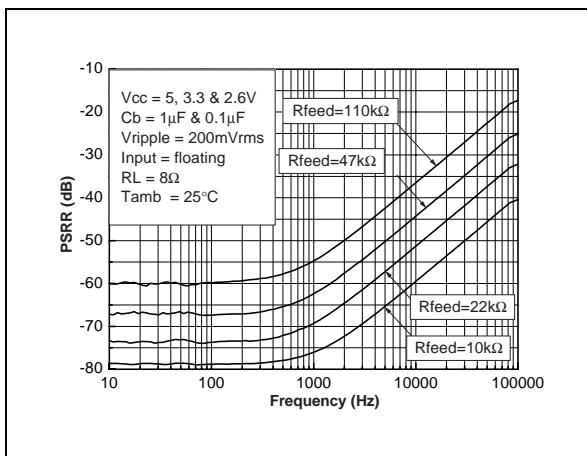

Fig. 15 : Pout @ THD + N = 1% vs Supply Voltage vs RL

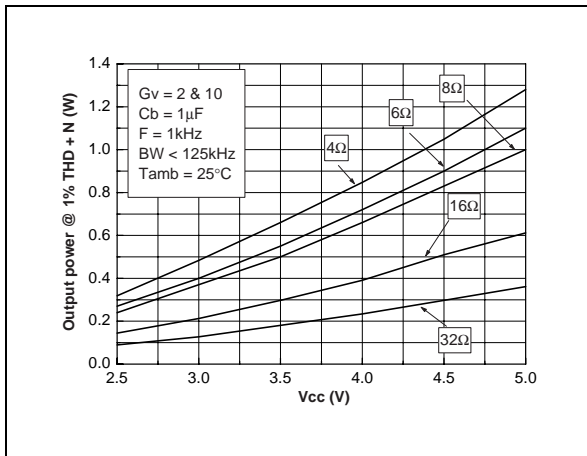

Fig. 16 : Pout @ THD + N = 10% vs Supply Voltage vs RL

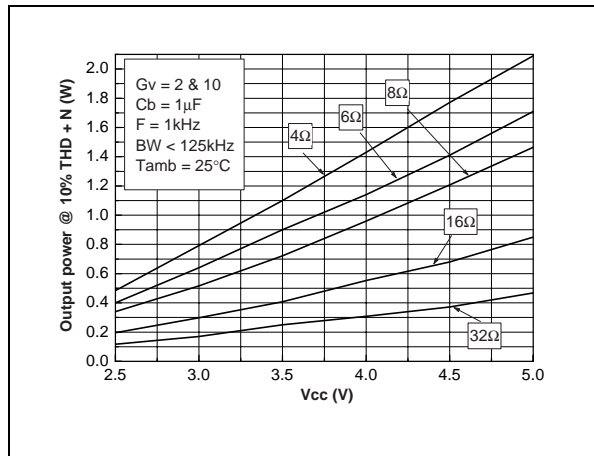

Fig. 17 : Power Dissipation vs Pout

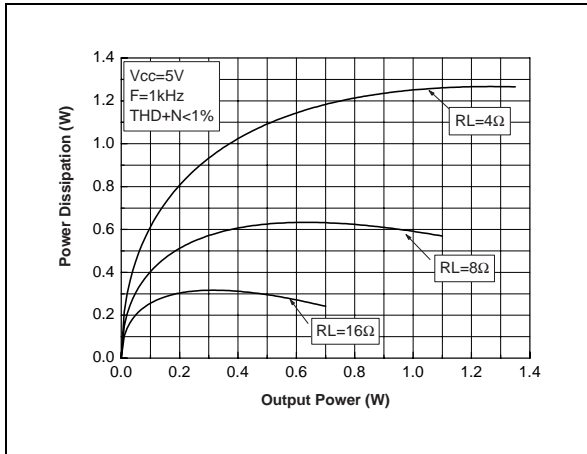

Fig. 18 : Power Dissipation vs Pout

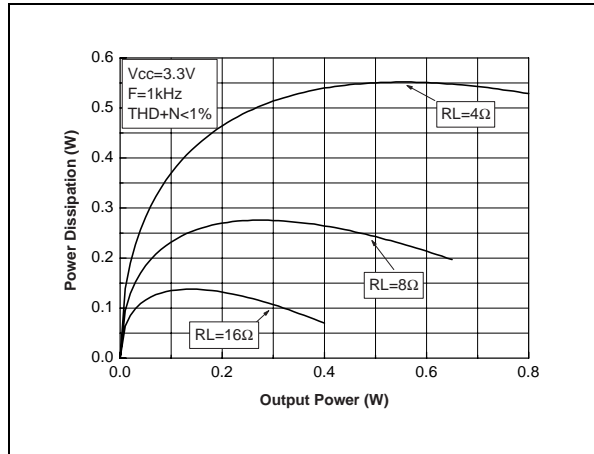

Fig. 19 : Power Dissipation vs Pout

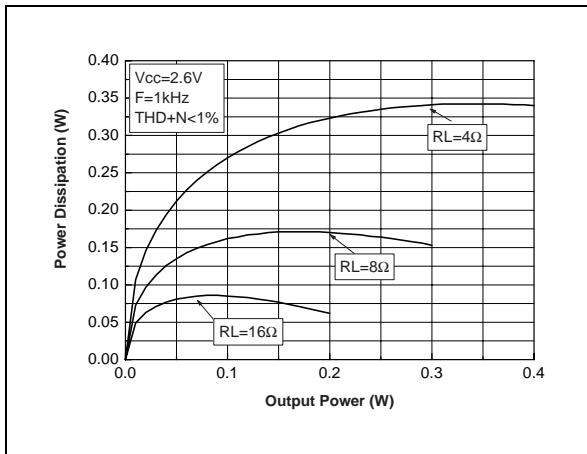

Fig. 20 : Power Derating Curves

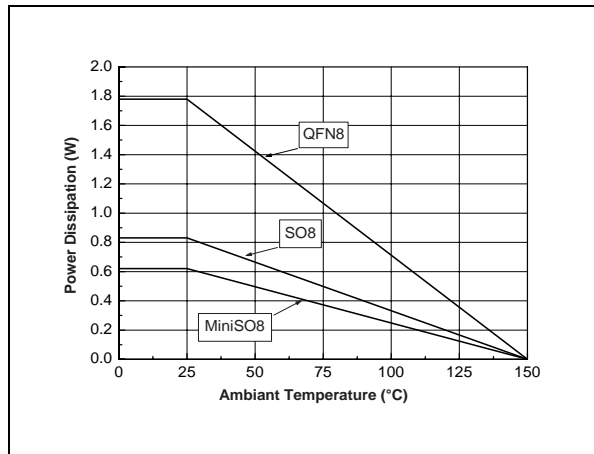

Fig. 21 : THD + N vs Output Power

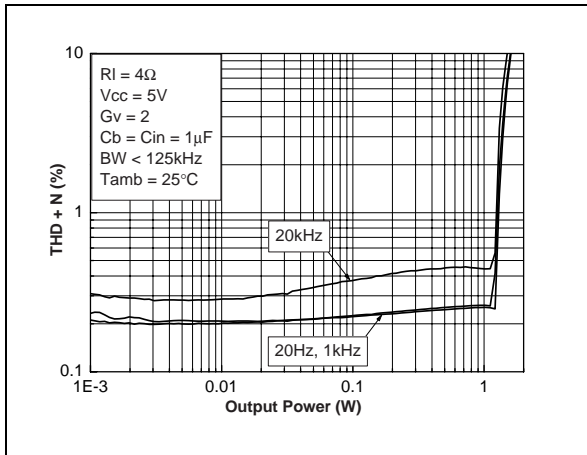

Fig. 22 : THD + N vs Output Power

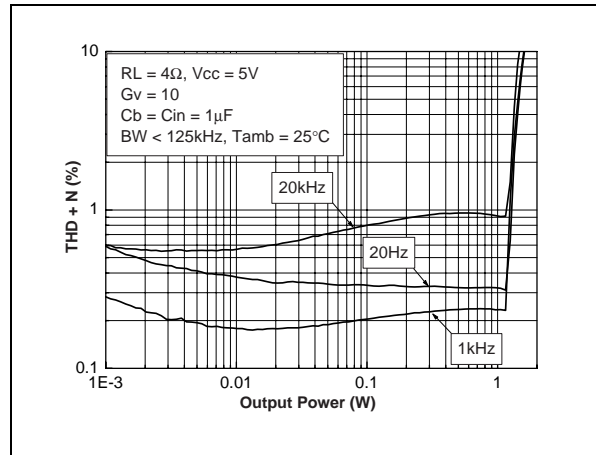

Fig. 23 : THD + N vs Output Power

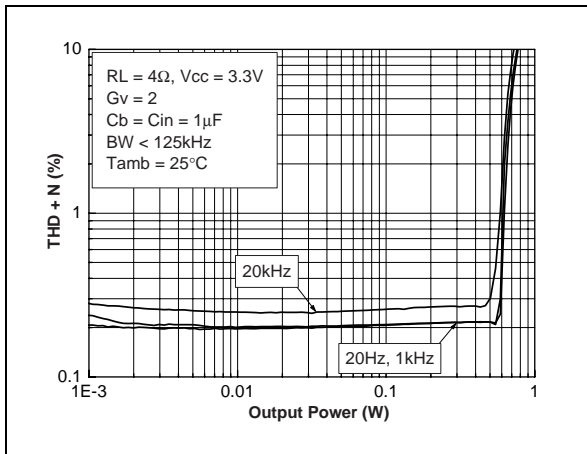

Fig. 24 : THD + N vs Output Power

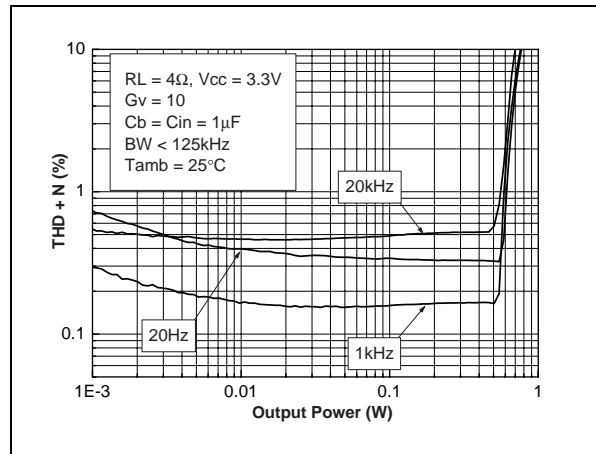

Fig. 25 : THD + N vs Output Power

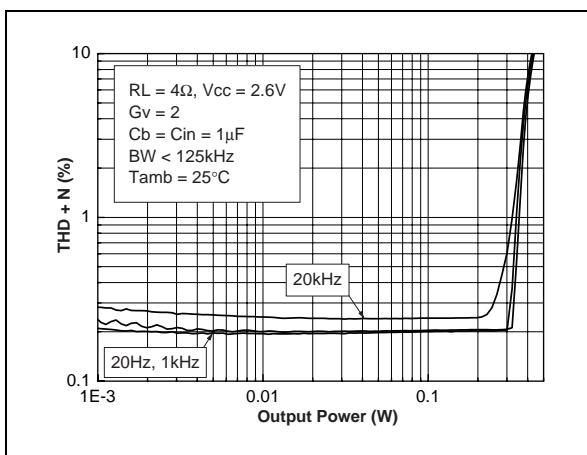

Fig. 26 : THD + N vs Output Power

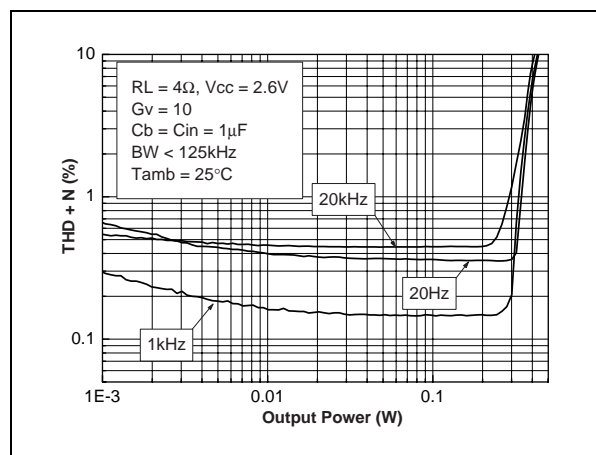

Fig. 27 : THD + N vs Output Power

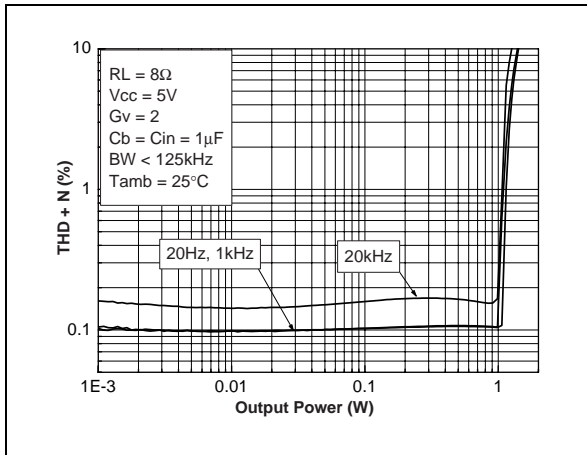

Fig. 28 : THD + N vs Output Power

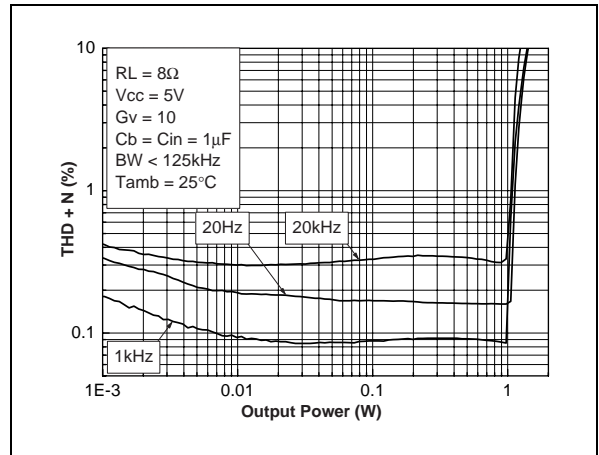

Fig. 29 : THD + N vs Output Power

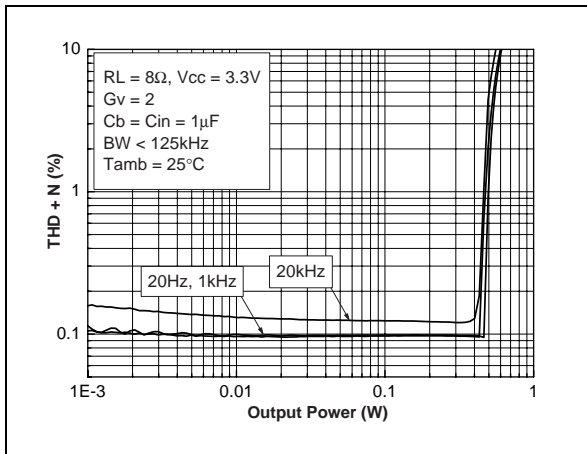

Fig. 30 : THD + N vs Output Power

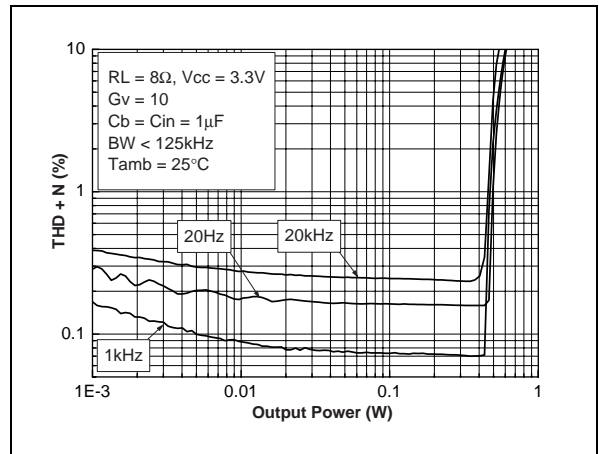

Fig. 31 : THD + N vs Output Power

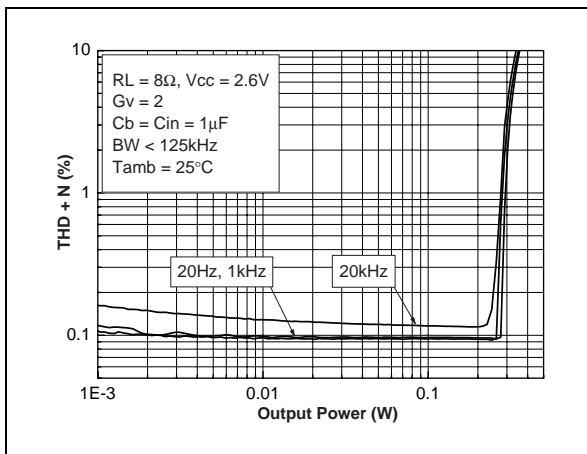

Fig. 32 : THD + N vs Output Power

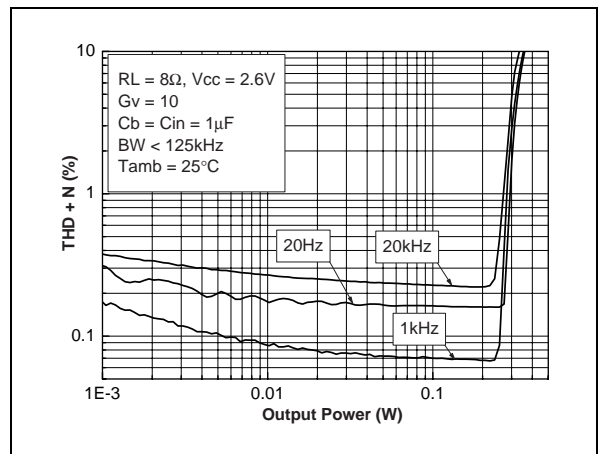

Fig. 33 : THD + N vs Output Power

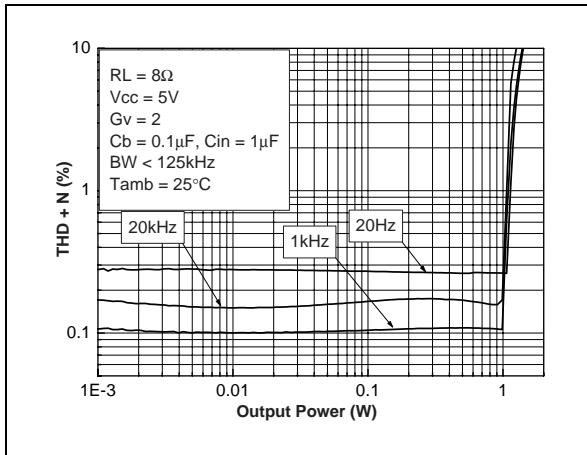

Fig. 34 : THD + N vs Output Power

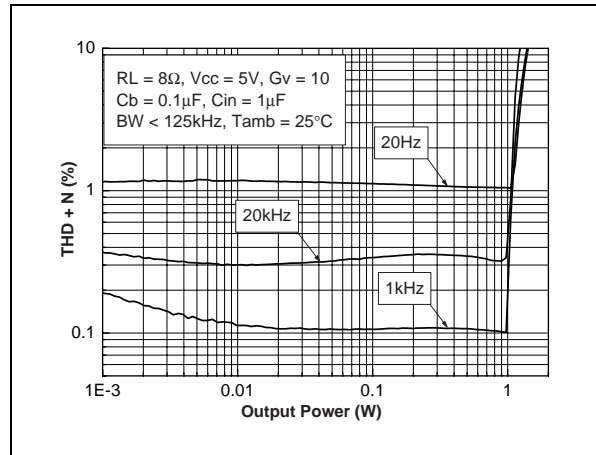

Fig. 35 : THD + N vs Output Power

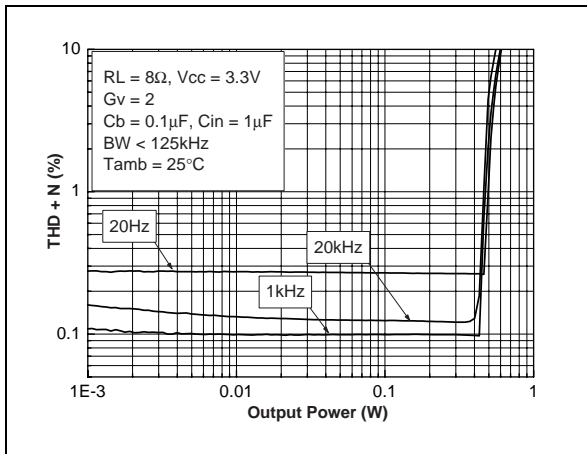

Fig. 36 : THD + N vs Output Power

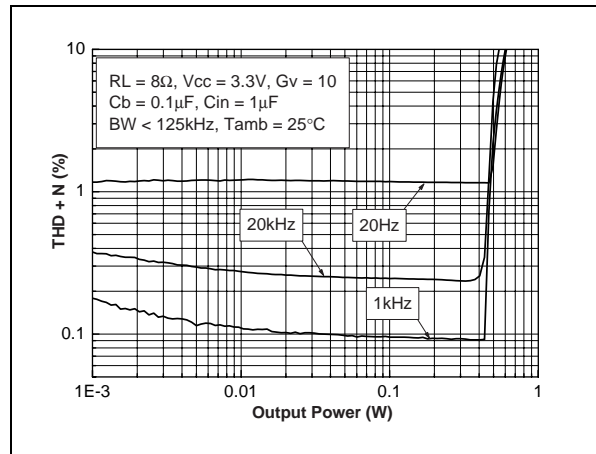

Fig. 37 : THD + N vs Output Power

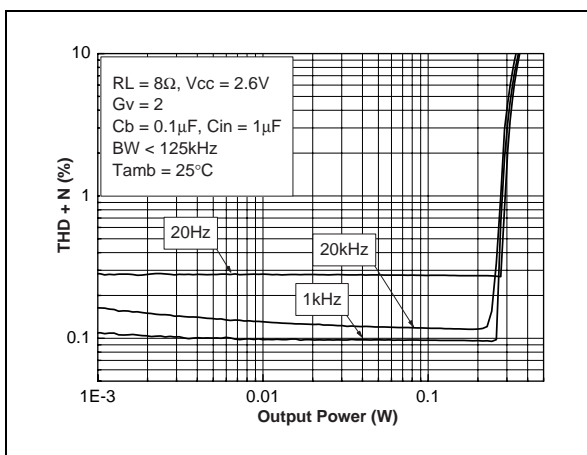

Fig. 38 : THD + N vs Output Power

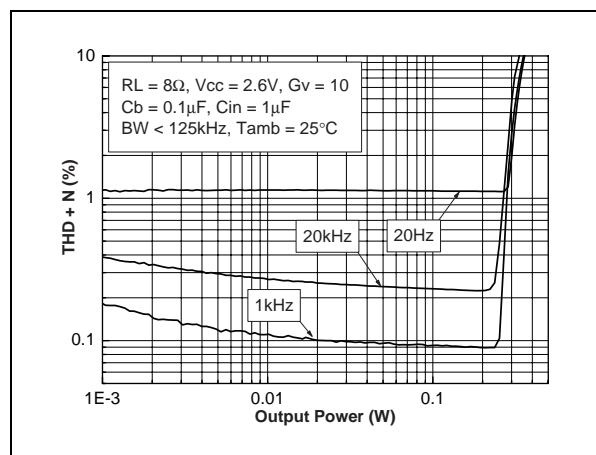

Fig. 39 : THD + N vs Output Power

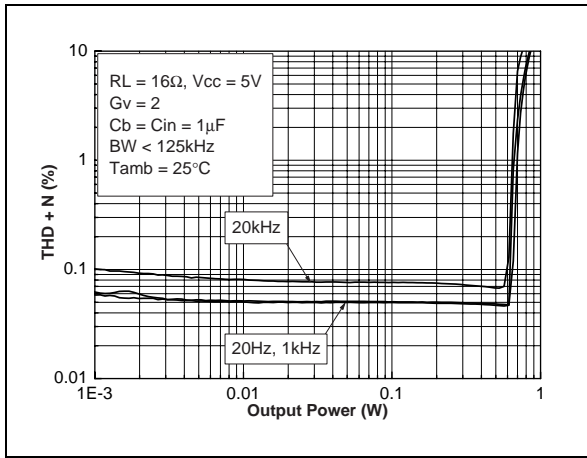

Fig. 40 : THD + N vs Output Power

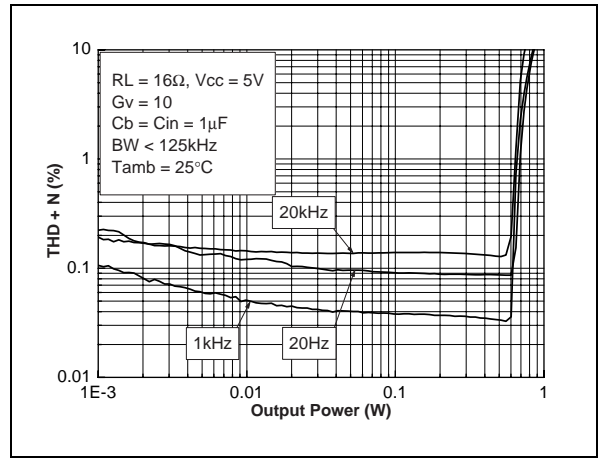

Fig. 41 : THD + N vs Output Power

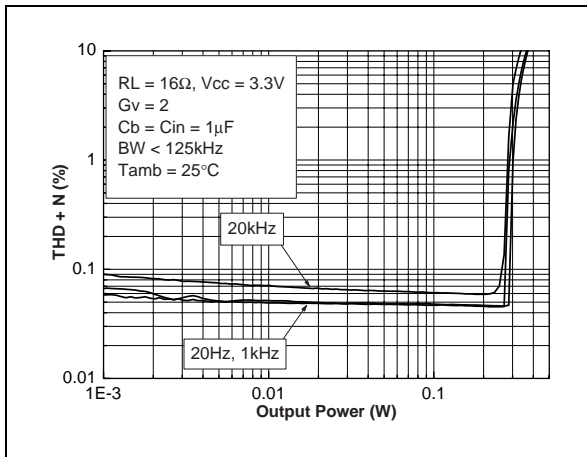

Fig. 42 : THD + N vs Output Power

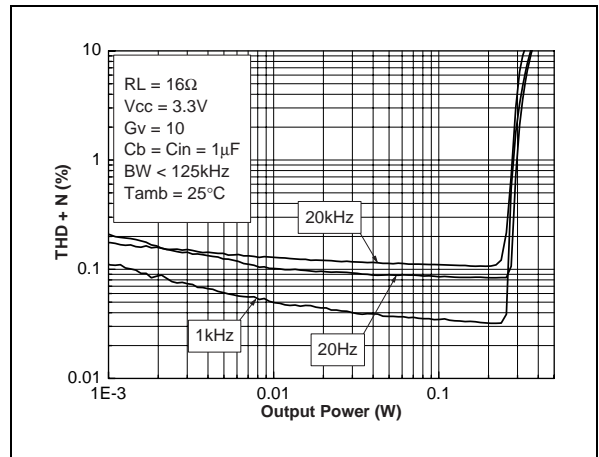

Fig. 43 : THD + N vs Output Power

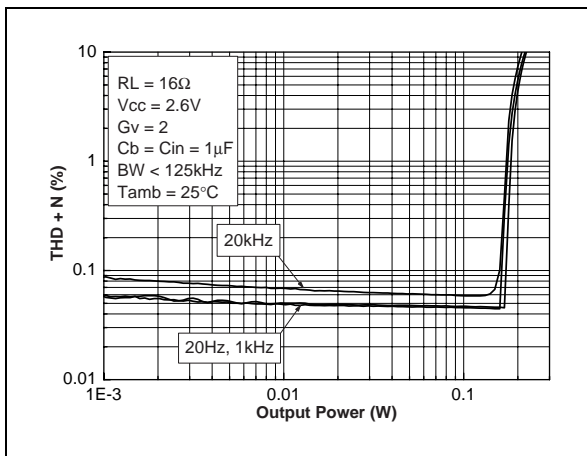

Fig. 44 : THD + N vs Output Power

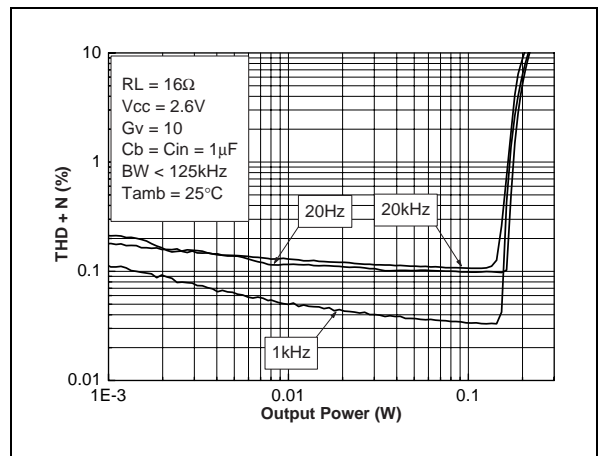

Fig. 45 : THD + N vs Frequency

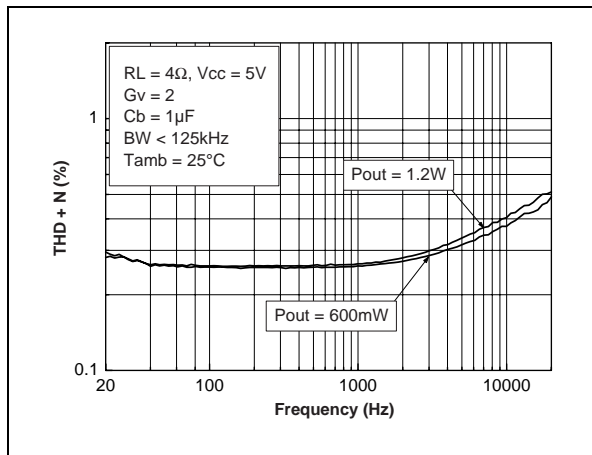

Fig. 46 : THD + N vs Frequency

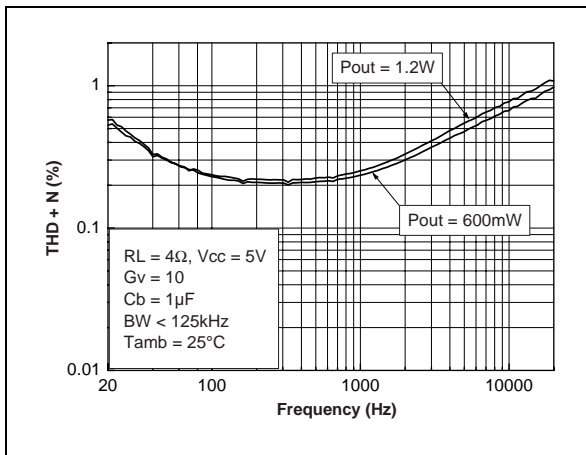

Fig. 47 : THD + N vs Frequency

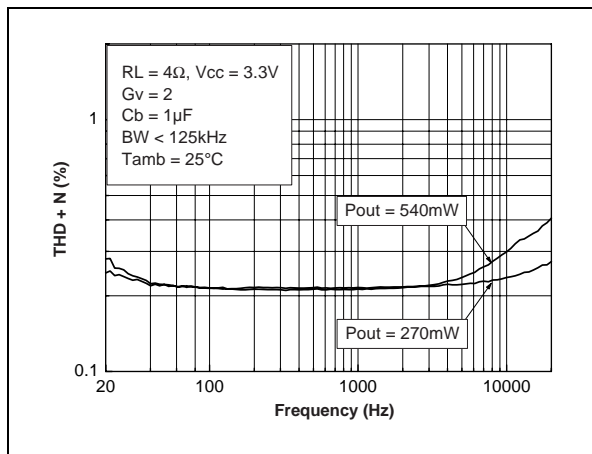

Fig. 48 : THD + N vs Frequency

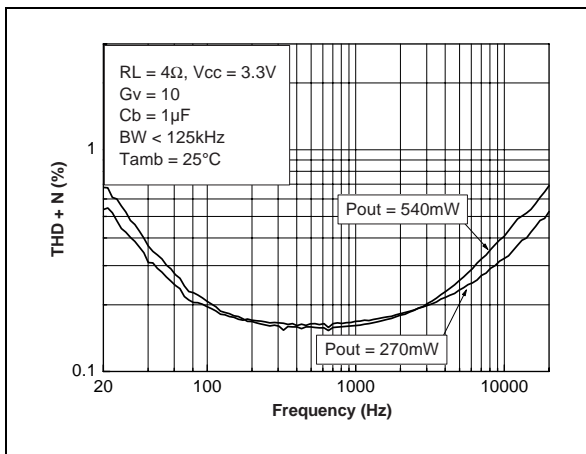

Fig. 49 : THD + N vs Frequency

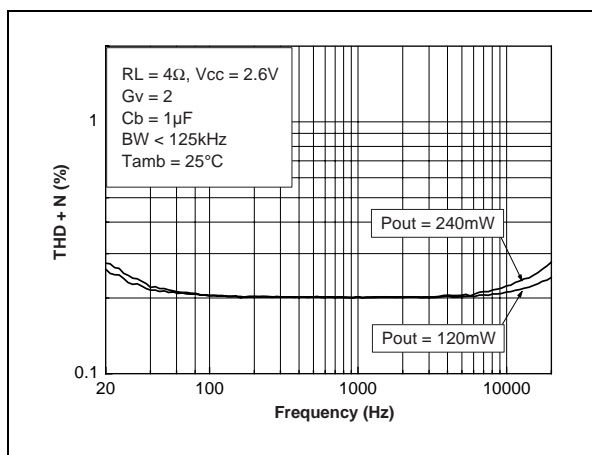

Fig. 50 : THD + N vs Frequency

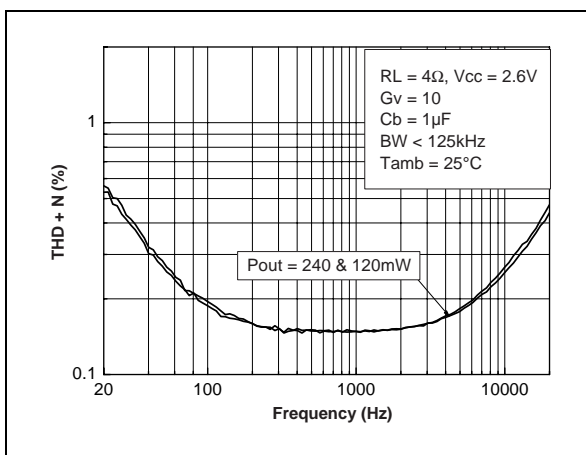

Fig. 51 : THD + N vs Frequency

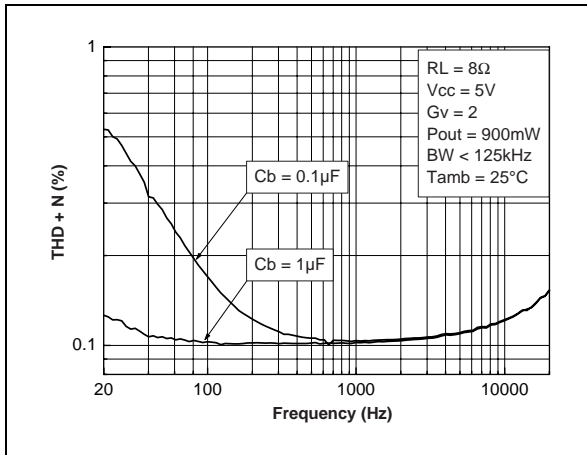

Fig. 52 : THD + N vs Frequency

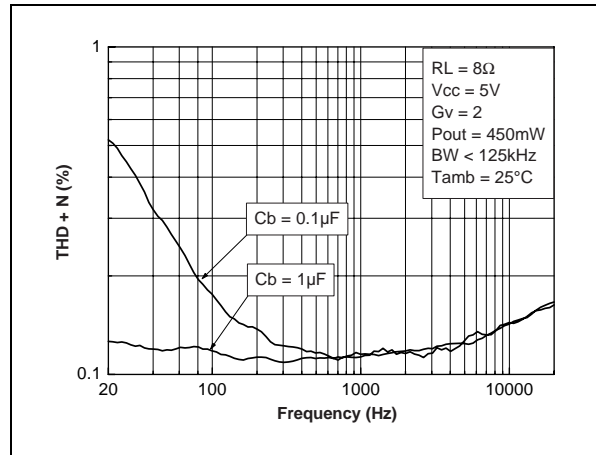

Fig. 53 : THD + N vs Frequency

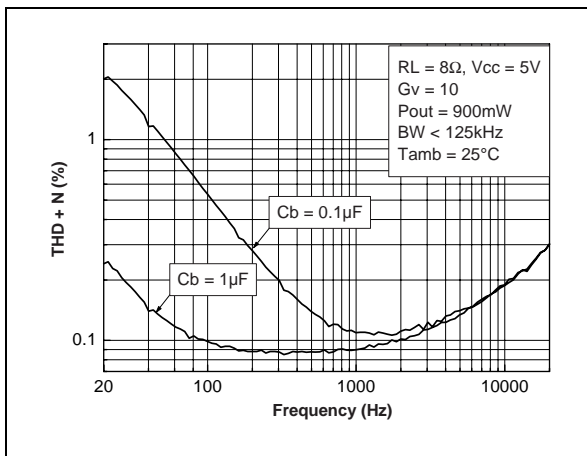

Fig. 54 : THD + N vs Frequency

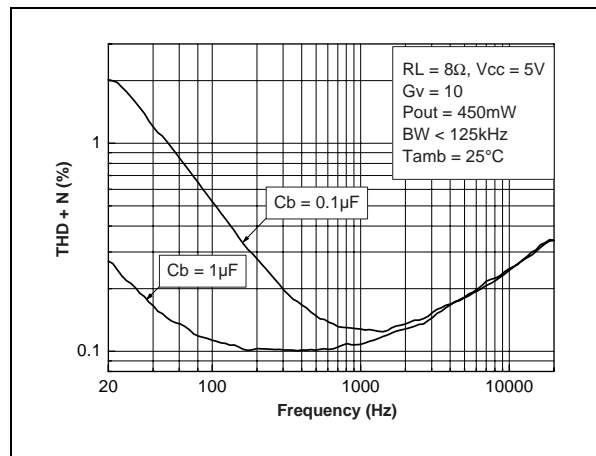

Fig. 55 : THD + N vs Frequency

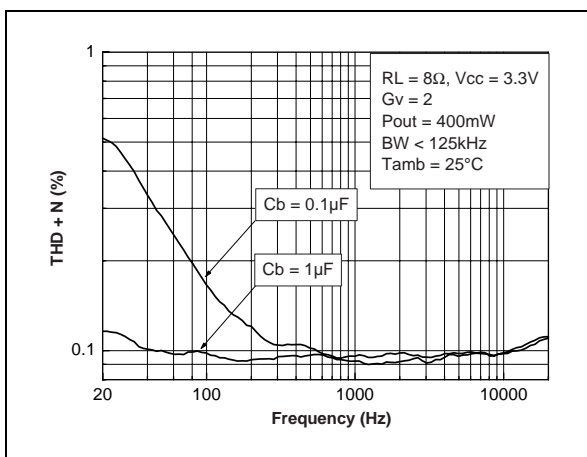

Fig. 56 : THD + N vs Frequency

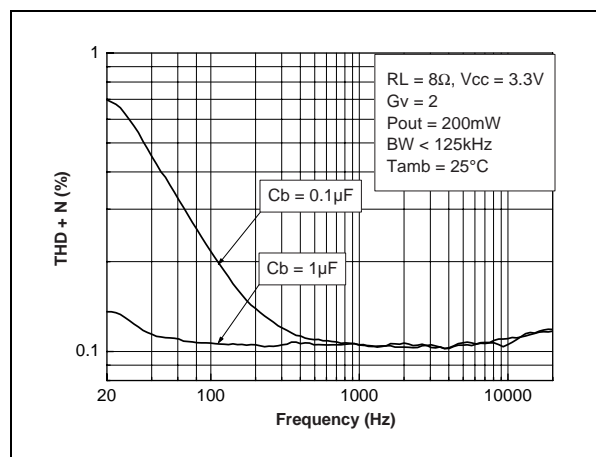

Fig. 57 : THD + N vs Frequency

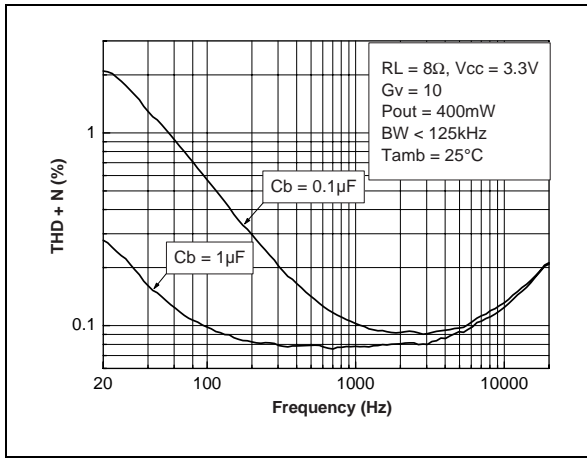

Fig. 58 : THD + N vs Frequency

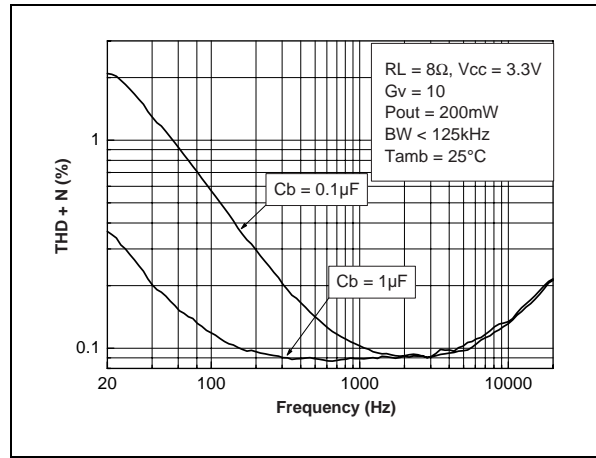

Fig. 59 : THD + N vs Frequency

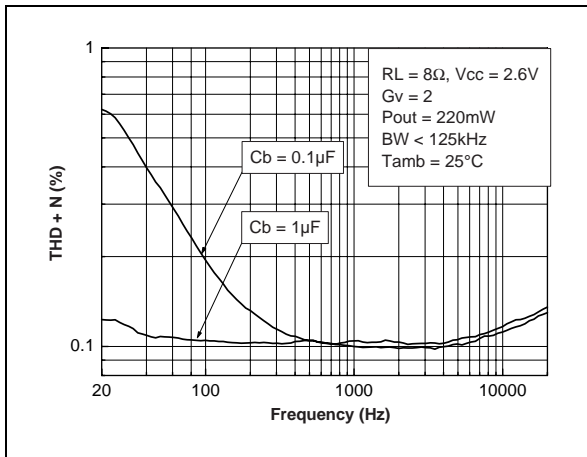

Fig. 60 : THD + N vs Frequency

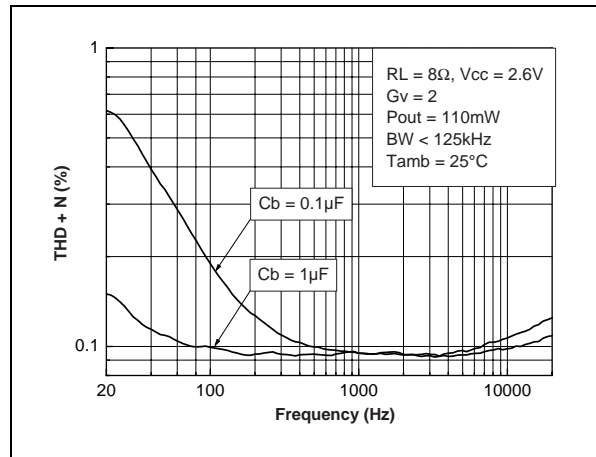

Fig. 61 : THD + N vs Frequency

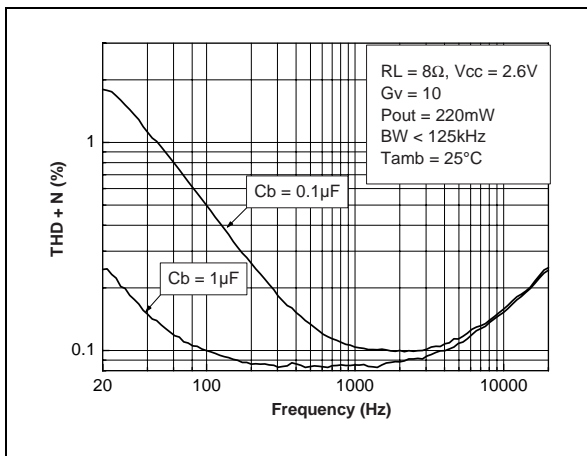

Fig. 62 : THD + N vs Frequency

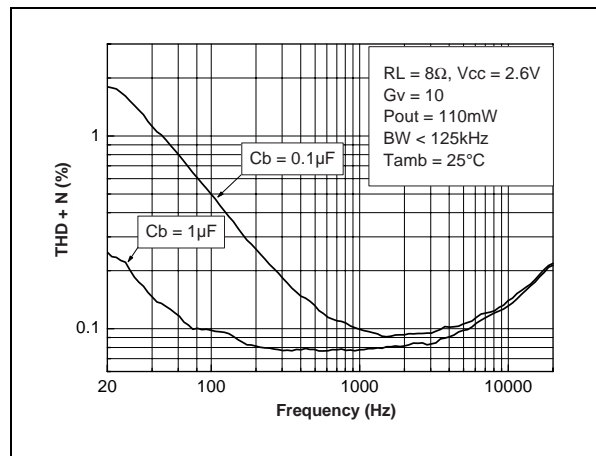

Fig. 63 : THD + N vs Frequency

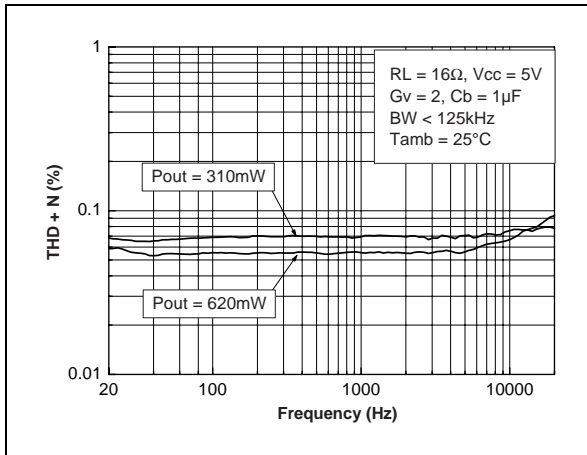

Fig. 64 : THD + N vs Frequency

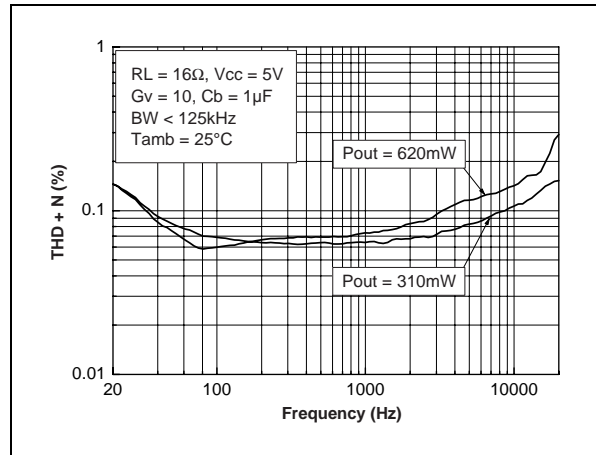

Fig. 65 : THD + N vs Frequency

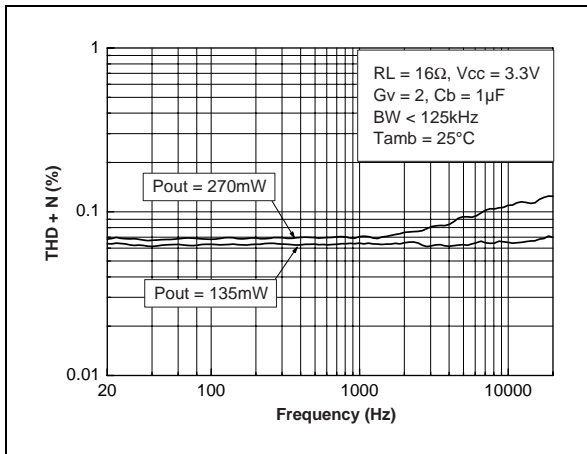

Fig. 66 : THD + N vs Frequency

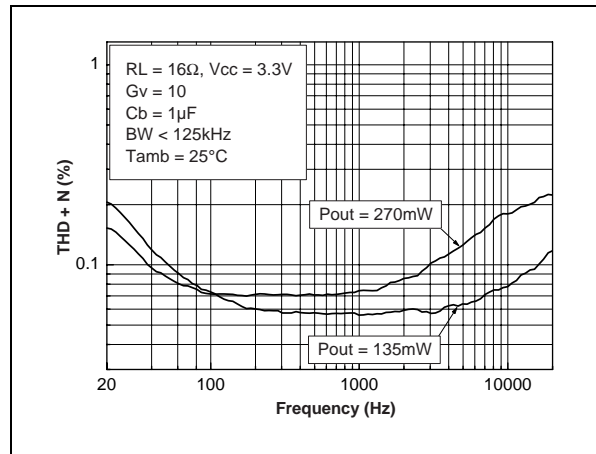

Fig. 67 : THD + N vs Frequency

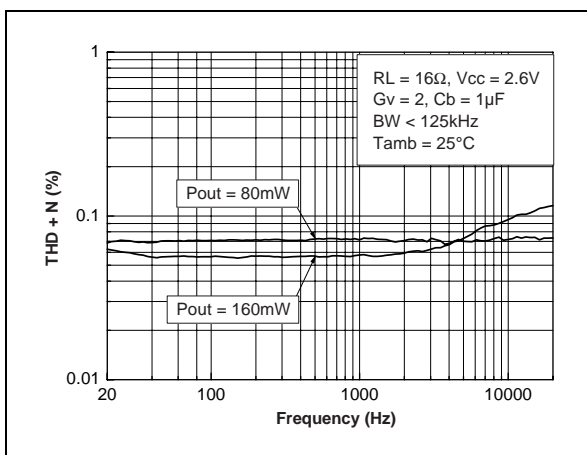

Fig. 68 : THD + N vs Frequency

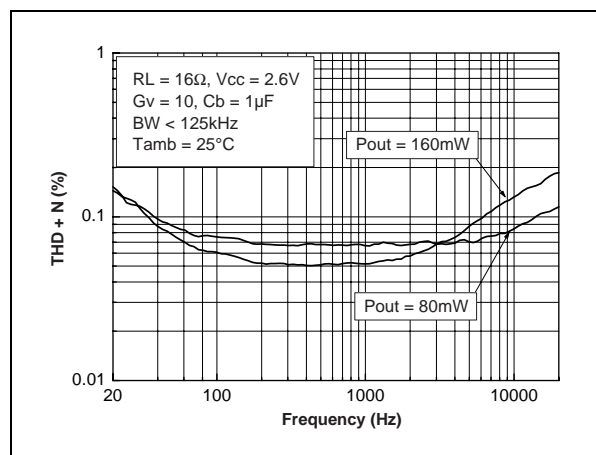

Fig. 69 : Signal to Noise Ratio vs Power Supply with Unweighted Filter (20Hz to 20kHz)

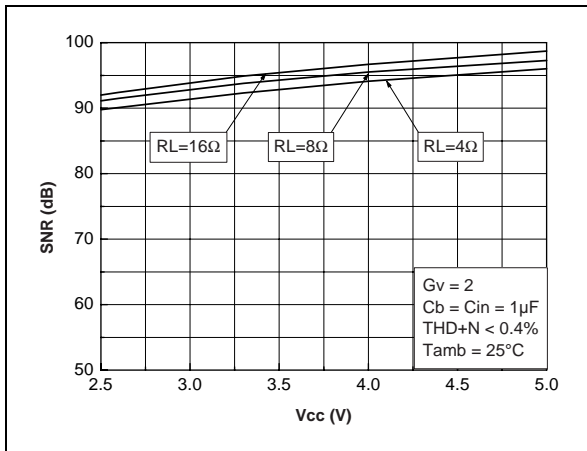

Fig. 70 : Signal to Noise Ratio vs Power Supply with Weighted Filter Type A

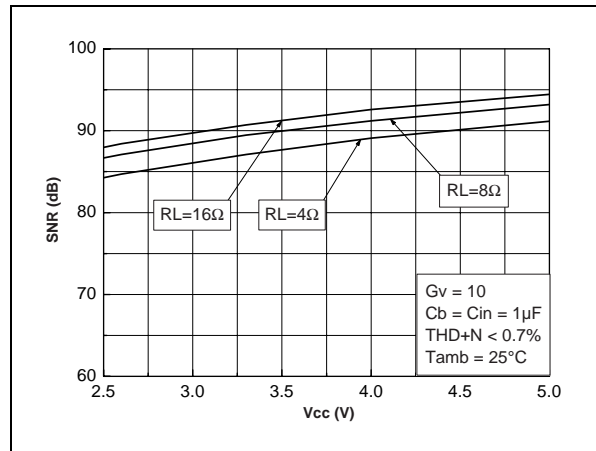

Fig. 71 : Signal to Noise Ratio vs Power Supply with Weighted Filter type A

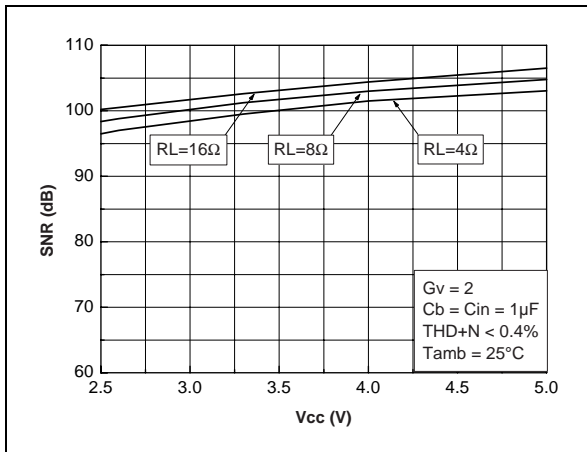

Fig. 72 : Current Consumption vs Power Supply Voltage

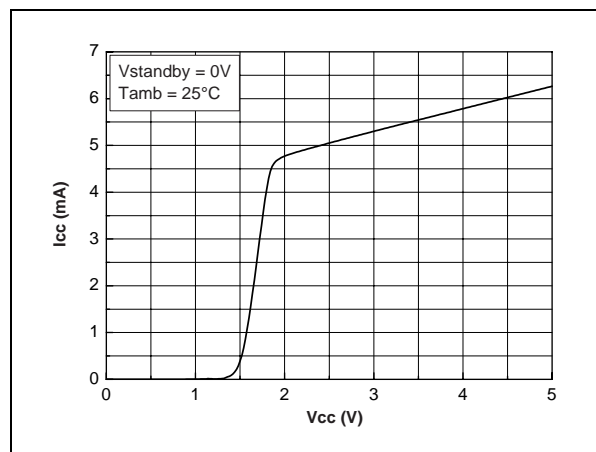

Fig. 73 : Signal to Noise Ratio Vs Power Supply with Unweighted Filter (20Hz to 20kHz)

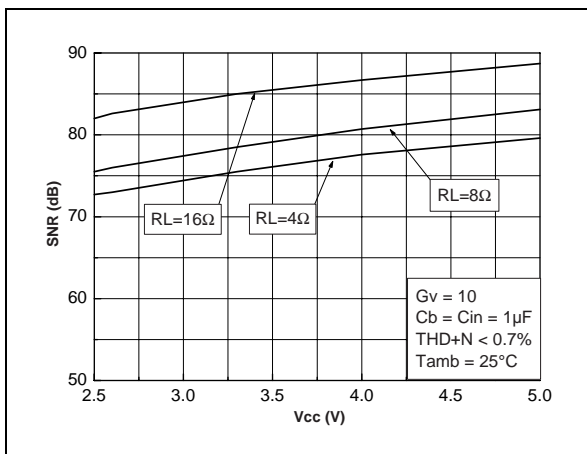

Fig. 74 : Current Consumption vs Standby Voltage @ Vcc = 5V

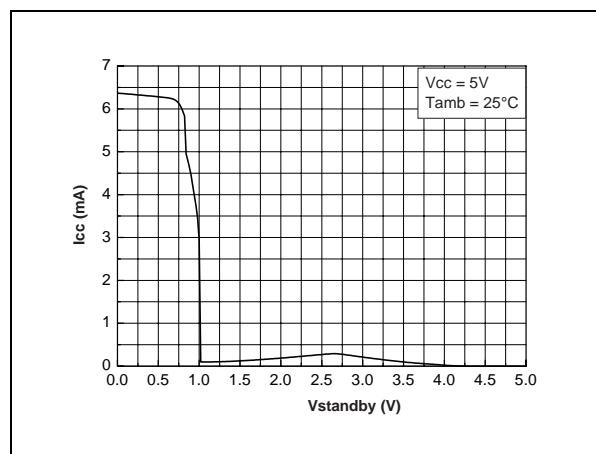

Fig. 75 : Current Consumption vs Standby Voltage @ Vcc = 2.6V

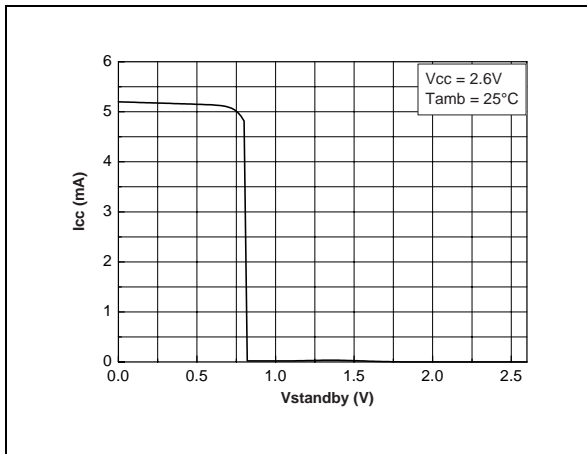

Fig. 76 : Current Consumption vs Standby Voltage @ Vcc = 3.3V

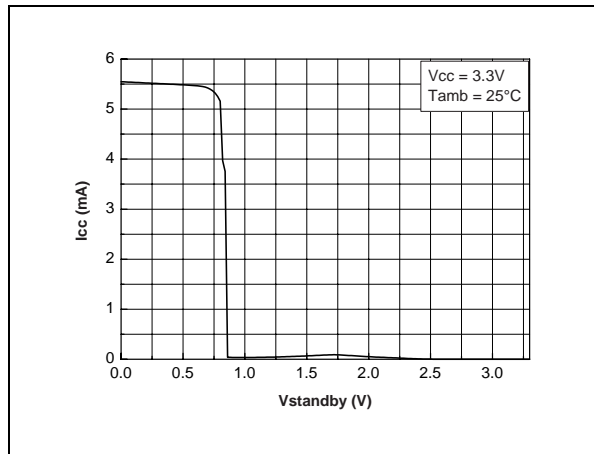

Fig. 77 : Clipping Voltage vs Power Supply Voltage and Load Resistor

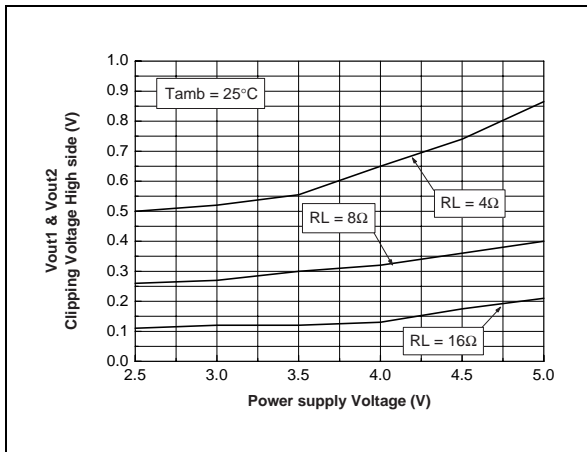

Fig. 78 : Clipping Voltage vs Power Supply Voltage and Load Resistor

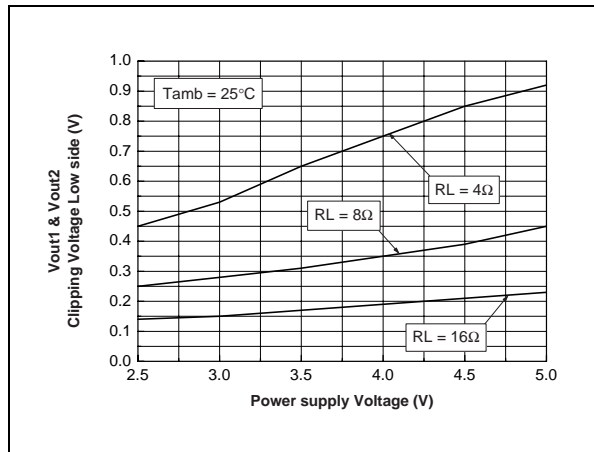

Fig. 79 : Vout1+Vout2 Unweighted Noise Floor

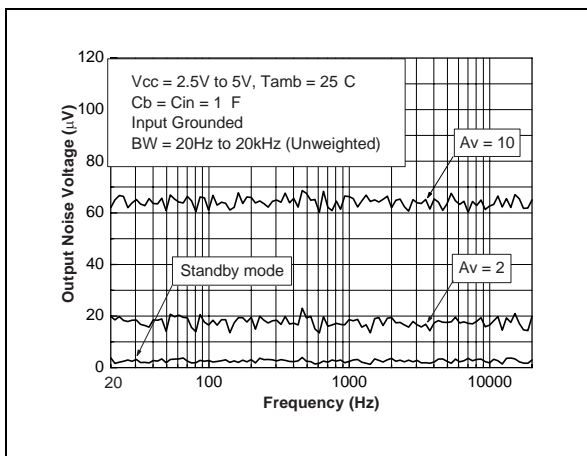
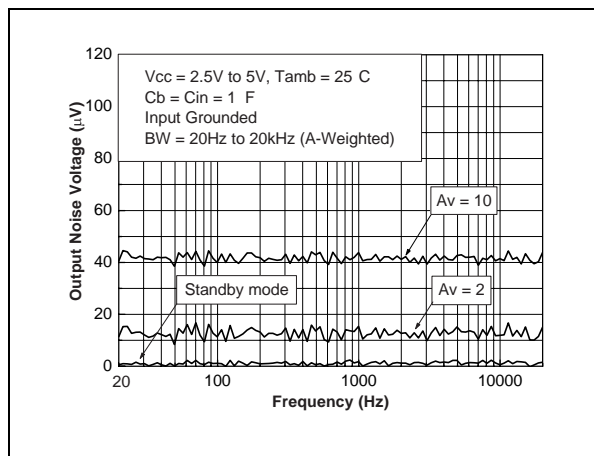

Fig. 80 : Vout1+Vout2 A-weighted Noise Floor



APPLICATION INFORMATION
Fig. 81 : Demoboard Schematic

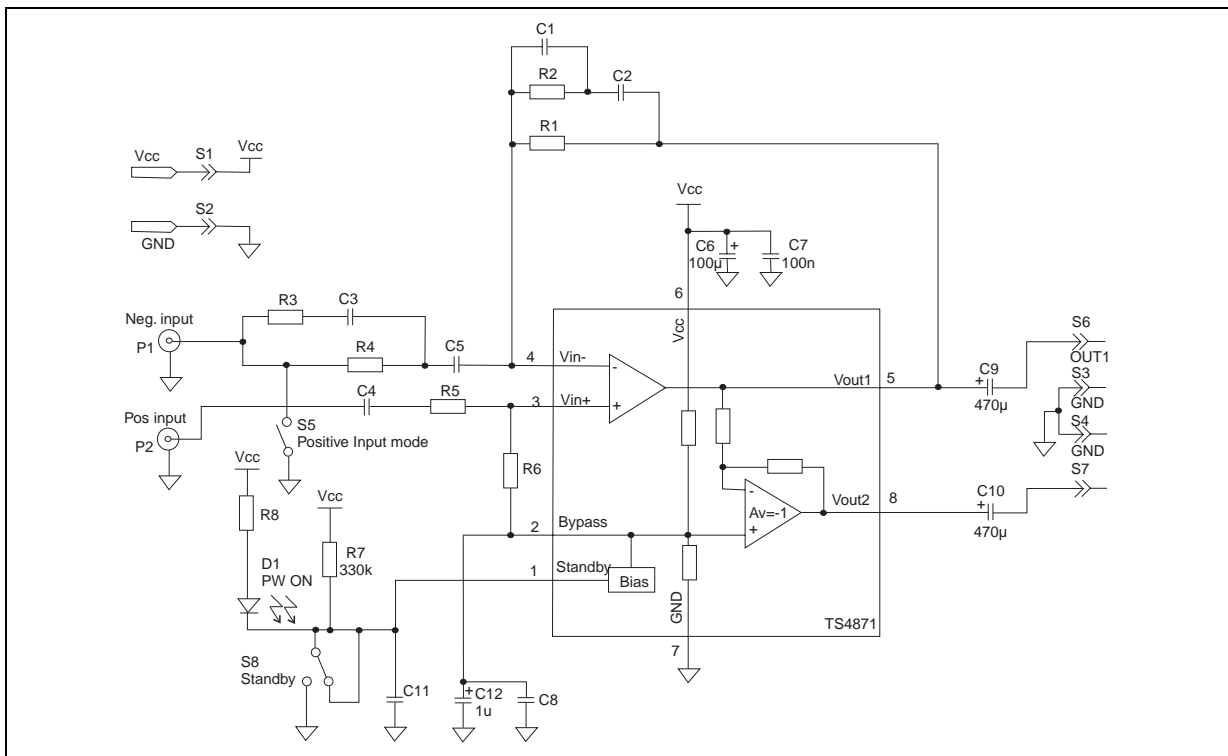

Fig. 82 : SO8 & MiniSO8 Demoboard Components Side

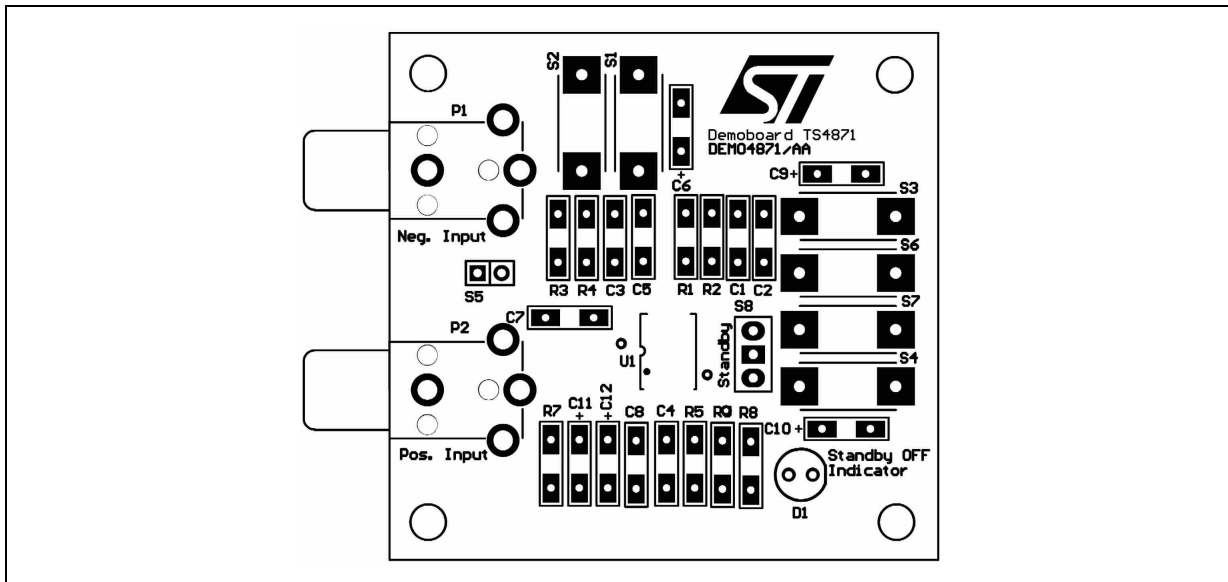

Fig. 83 : SO8 & MiniSO8 Demoboard Top Solder Layer

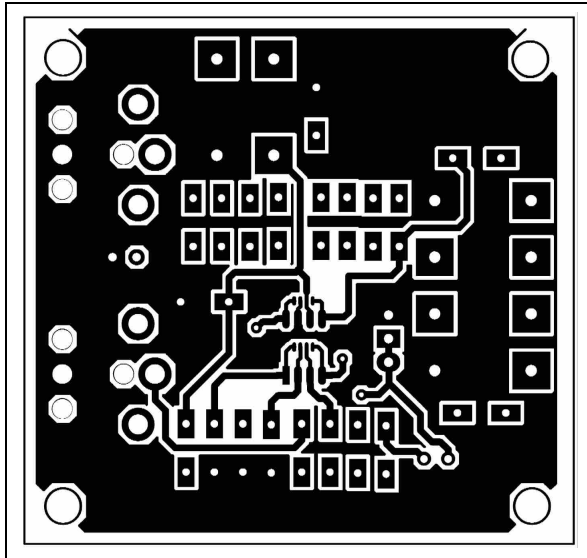
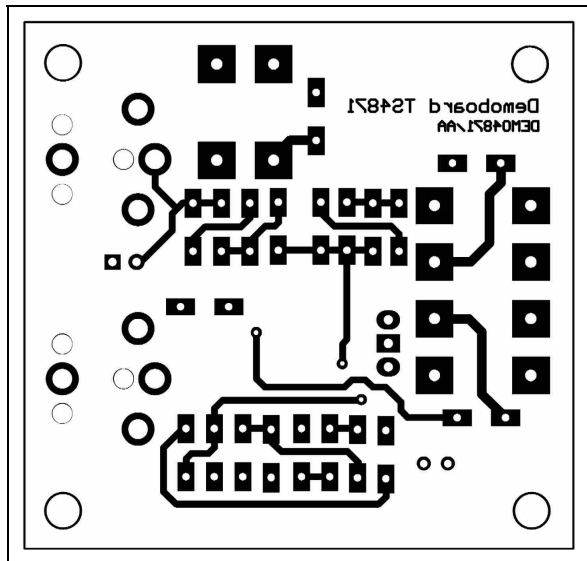

Fig. 84 : SO8 & MiniSO8 Demoboard Bottom Solder Layer



■ BTL Configuration Principle

The TS4871 is a monolithic power amplifier with a BTL output type. BTL (Bridge Tied Load) means that each end of the load is connected to two single ended output amplifiers. Thus, we have :

Single ended output 1 = $V_{out1} = V_{out}$ (V)
 Single ended output 2 = $V_{out2} = -V_{out}$ (V)

And $V_{out1} - V_{out2} = 2V_{out}$ (V)

The output power is:

$$P_{out} = \frac{(2 V_{out_{RMS}})^2}{R_L} \text{ (W)}$$

For the same power supply voltage, the output power in BTL configuration is four times higher than the output power in single ended configuration.

■ Gain In Typical Application Schematic (see page 1)

In flat region (no effect of C_{in}), the output voltage of the first stage is:

$$V_{out1} = -V_{in} \frac{R_{feed}}{R_{in}} \text{ (V)}$$

For the second stage : $V_{out2} = -V_{out1}$ (V)

The differential output voltage is:

$$V_{out2} - V_{out1} = 2V_{in} \frac{R_{feed}}{R_{in}} \text{ (V)}$$

The differential gain named gain (G_v) for more convenient usage is:

$$G_v = \frac{V_{out2} - V_{out1}}{V_{in}} = 2 \frac{R_{feed}}{R_{in}}$$

Remark : V_{out2} is in phase with V_{in} and V_{out1} is 180 phased with V_{in} . It means that the positive terminal of the loudspeaker should be connected to V_{out2} and the negative to V_{out1} .

■ Low and high frequency response

In low frequency region, the effect of C_{in} starts. C_{in} with R_{in} forms a high pass filter with a -3dB cut off frequency.

$$F_{CL} = \frac{1}{2\pi R_{in} C_{in}} \text{ (Hz)}$$

In high frequency region, you can limit the bandwidth by adding a capacitor (C_{feed}) in parallel on R_{feed} . Its form a low pass filter with a -3dB cut off frequency.

$$F_{CH} = \frac{1}{2\pi R_{feed} C_{feed}} \text{ (Hz)}$$

■ Power dissipation and efficiency

Hypothesis :

- Voltage and current in the load are sinusoidal (V_{out} and I_{out})
- Supply voltage is a pure DC source (V_{cc})

Regarding the load we have:

$$V_{OUT} = V_{PEAK} \sin \omega t \text{ (V)}$$

and

$$I_{OUT} = \frac{V_{OUT}}{R_L} \text{ (A)}$$

and

$$P_{OUT} = \frac{V_{PEAK}^2}{2R_L} \text{ (W)}$$

Then, the average current delivered by the supply voltage is:

$$I_{CC\ AVG} = 2 \frac{V_{PEAK}}{\pi R_L} \text{ (A)}$$

The power delivered by the supply voltage is
 $P_{supply} = V_{cc} I_{CC\ AVG} \text{ (W)}$

Then, the **power dissipated by the amplifier** is
 $P_{diss} = P_{supply} - P_{out} \text{ (W)}$

$$P_{diss} = \frac{2\sqrt{2}V_{cc}}{\pi\sqrt{R_L}} \sqrt{P_{OUT}} - P_{OUT} \text{ (W)}$$

and the maximum value is obtained when:

$$\frac{\partial P_{diss}}{\partial P_{OUT}} = 0$$

and its value is:

$$P_{diss\ max} = \frac{2V_{cc}^2}{\pi^2 R_L} \text{ (W)}$$

Remark : This maximum value is only depending on power supply voltage and load values.

The **efficiency** is the ratio between the output power and the power supply

$$\eta = \frac{P_{OUT}}{P_{supply}} = \frac{\pi V_{PEAK}}{4V_{CC}}$$

The maximum theoretical value is reached when $V_{peak} = V_{cc}$, so

$$\frac{\pi}{4} = 78.5\%$$

■ Decoupling of the circuit

Two capacitors are needed to bypass properly the TS4871, a power supply bypass capacitor C_s and a bias voltage bypass capacitor C_b .

C_s has especially an influence on the THD+N in high frequency (above 7kHz) and indirectly on the power supply disturbances.

With 100μF, you can expect similar THD+N performances like shown in the datasheet.

If C_s is lower than 100μF, in high frequency increases, THD+N and disturbances on the power supply rail are less filtered.

To the contrary, if C_s is higher than 100μF, those disturbances on the power supply rail are more filtered.

C_b has an influence on THD+N in lower frequency, but its function is critical on the final result of PSRR with input grounded in lower frequency.

If C_b is lower than 1μF, THD+N increase in lower frequency (see THD+N vs frequency curves) and the PSRR worsens up

If C_b is higher than 1μF, the benefit on THD+N in lower frequency is small but the benefit on PSRR is substantial (see PSRR vs. C_b curve : fig.12).

Note that C_{in} has a non-negligible effect on PSRR in lower frequency. Lower is its value, higher is the PSRR (see fig. 13).

■ Pop and Click performance

Pop and Click performance is intimately linked with the size of the input capacitor C_{in} and the bias voltage bypass capacitor C_b .

Size of C_{in} is due to the lower cut-off frequency and PSRR value requested. Size of C_b is due to THD+N and PSRR requested always in lower frequency.

Moreover, C_b determines the speed that the amplifier turns ON. The slower the speed is, the softer the turn ON noise is.

The charge time of C_b is directly proportional to

the internal generator resistance 50kΩ.
Then, the charge time constant for Cb is
 $\tau_b = 50k\Omega \times C_b$ (s)

As Cb is directly connected to the non-inverting input (pin 2 & 3) and if we want to minimize, in amplitude and duration, the output spike on Vout1 (pin 5), Cin must be charged faster than Cb. The charge time constant of Cin is
 $\tau_{in} = (R_{in} + R_{feed}) \times C_{in}$ (s)

Thus we have the relation
 $\tau_{in} \ll \tau_b$ (s)

The respect of this relation permits to minimize the pop and click noise.

Remark : Minimize Cin and Cb has a benefit on pop and click phenomena but also on cost and size of the application.

Example : your target for the -3dB cut off frequency is 100 Hz. With Rin=Rfeed=22 kΩ, Cin=72nF (in fact 82nF or 100nF).

With Cb=1μF, if you choose the one of the latest two values of Cin, the pop and click phenomena at power supply ON or standby function ON/OFF will be very small

50 kΩx1μF >> 44kΩx100nF (50ms >> 4.4ms).

Increasing Cin value increases the pop and click phenomena to an unpleasant sound at power supply ON and standby function ON/OFF.

Why Cs is not important in pop and click consideration ?

Hypothesis :

- Cs = 100μF
- Supply voltage = 5V
- Supply voltage internal resistor = 0.1Ω
- Supply current of the amplifier Icc = 6mA

At power ON of the supply, the supply capacitor is charged through the internal power supply resistor. So, to reach 5V you need about five to ten times the charging time constant of Cs ($\tau_s = 0.1 \times C_s$ (s)).

Then, this time equal 50μs to 100μs << τb in the majority of application.

At power OFF of the supply, Cs is discharged by a constant current Icc. The discharge time from 5V to 0V of Cs is:

$$t_{DischCs} = \frac{5C_s}{I_{CC}} = 83 \text{ ms}$$

Now, we must consider the discharge time of Cb. At power OFF or standby ON, Cb is discharged by a 100kΩ resistor. So the discharge time is about $\tau_{bDisch} \approx 3 \times C_b \times 100k\Omega$ (s). In the majority of application, Cb=1μF, then $\tau_{bDisch} \approx 300ms \gg t_{dischCs}$.

■ Power amplifier design examples

Given :

- Load impedance : 8Ω
- Output power @ 1% THD+N : 0.5W
- Input impedance : 10kΩ min.
- Input voltage peak to peak : 1Vpp
- Bandwidth frequency : 20Hz to 20kHz (0, -3dB)
- Ambient temperature max = 50°C
- SO8 package

First of all, we must calculate the minimum power supply voltage to obtain 0.5W into 8Ω. With curves in fig. 15, we can read 3.5V. Thus, the power supply voltage value min. will be 3.5V.

Following the maximum power dissipation equation

$$P_{dissmax} = \frac{2V_{cc}^2}{\pi^2 R_L} \text{ (W)}$$

with 3.5V we have P_{dissmax}=0.31W.

Refer to power derating curves (fig. 20), with 0.31W the maximum ambient temperature will be 100°C. This last value could be higher if you follow the example layout shown on the demoboard (better dissipation).

The gain of the amplifier in flat region will be:

$$G_V = \frac{V_{OUTPP}}{V_{INPP}} = \frac{2\sqrt{2R_L P_{OUT}}}{V_{INPP}} = 5.65$$

We have Rin > 10kΩ. Let's take Rin = 10kΩ, then Rfeed = 28.25kΩ. We could use for Rfeed = 30kΩ in normalized value and the gain will be Gv = 6.

In lower frequency we want 20 Hz (-3dB cut off frequency). Then:

So, we could use for Cin a 1μF capacitor value

$$C_{IN} = \frac{1}{2\pi R_{in}F_{CL}} = 795nF$$

which gives 16Hz.

In Higher frequency we want 20kHz (-3dB cut off frequency). The Gain Bandwidth Product of the TS4871 is 2MHz typical and doesn't change when the amplifier delivers power into the load.

The first amplifier has a gain of:

$$\frac{R_{feed}}{R_{in}} = 3$$

and the theoretical value of the -3dB cut-off higher frequency is $2MHz/3 = 660kHz$.

We can keep this value or limit the bandwidth by adding a capacitor C_{feed} , in parallel on R_{feed} . Then:

$$C_{FEED} = \frac{1}{2\pi R_{FEED}F_{CH}} = 265pF$$

So, we could use for C_{feed} a 220pF capacitor value that gives 24kHz.

Now, we can calculate the value of C_b with the formula $\tau_b = 50k\Omega \times C_b \gg \tau_{in} = (R_{in} + R_{feed}) \times C_{in}$ which permits to reduce the pop and click effects. Then $C_b \gg 0.8\mu F$.

We can choose for C_b a normalized value of $2.2\mu F$ that gives good results in THD+N and PSRR.

In the following tables, you could find three another examples with values required for the demoboard.

Remark : components with (*) marking are optional.

Application n°1 : 20Hz to 20kHz bandwidth and 6dB gain BTL power amplifier.

Components :

| Designator | Part Type |
|----------------|--------------------------------------|
| R1 | 22k / 0.125W |
| R4 | 22k / 0.125W |
| R6 | Short Circuit |
| R7 | 330k / 0.125W |
| R8* | $(V_{cc} - V_{f_led}) / I_{f_led}$ |
| C5 | 470nF |
| C6 | 100 μ F |
| C7 | 100nF |
| C9 | Short Circuit |
| C10 | Short Circuit |
| C12 | 1 μ F |
| S1, S2, S6, S7 | 2mm insulated Plug 10.16mm pitch |
| S8 | 3 pts connector 2.54mm pitch |
| P1 | PCB Phono Jack |
| D1* | Led 3mm |
| U1 | TS4871ID or TS4871IS |

Application n°2 : 20Hz to 20kHz bandwidth and 20dB gain BTL power amplifier.

Components :

| Designator | Part Type |
|------------|--------------------------------------|
| R1 | 110k / 0.125W |
| R4 | 22k / 0.125W |
| R6 | Short Circuit |
| R7 | 330k / 0.125W |
| R8* | $(V_{cc} - V_{f_led}) / I_{f_led}$ |
| C5 | 470nF |
| C6 | 100 μ F |
| C7 | 100nF |

| Designator | Part Type |
|----------------|-------------------------------------|
| C9 | Short Circuit |
| C10 | Short Circuit |
| C12 | 1µF |
| S1, S2, S6, S7 | 2mm insulated Plug 10.16mm pitch |
| S8 | 3 pts connector 2.54mm pitch |
| P1 | PCB Phono Jack |
| D1* | Led 3mm |
| U1 | TS4871ID or TS4871IS |

Application n°3 : 50Hz to 10kHz bandwidth and 10dB gain BTL power amplifier.

Components :

| Designator | Part Type |
|----------------|-------------------------------------|
| R1 | 33k / 0.125W |
| R2 | Short Circuit |
| R4 | 22k / 0.125W |
| R6 | Short Circuit |
| R7 | 330k / 0.125W |
| R8* | (Vcc-Vf_led)/If_led |
| C2 | 470pF |
| C5 | 150nF |
| C6 | 100µF |
| C7 | 100nF |
| C9 | Short Circuit |
| C10 | Short Circuit |
| C12 | 1µF |
| S1, S2, S6, S7 | 2mm insulated Plug 10.16mm pitch |
| S8 | 3 pts connector 2.54mm pitch |
| P1 | PCB Phono Jack |
| D1* | Led 3mm |
| U1 | TS4871ID or TS4871IS |

Application n°4 : Differential inputs BTL power amplifier.

In this configuration, we need to place these components : R1, R4, R5, R6, R7, C4, C5, C12.

We have also : R4 = R5, R1 = R6, C4 = C5.

The gain of the amplifier is:

$$G_{VDIFF} = 2 \frac{R1}{R4}$$

For Vcc=5V, a 20Hz to 20kHz bandwidth and 20dB gain BTL power amplifier you could follow the bill of material below.

Components :

| Designator | Part Type |
|----------------|-------------------------------------|
| R1 | 110k / 0.125W |
| R4 | 22k / 0.125W |
| R5 | 22k / 0.125W |
| R6 | 110k / 0.125W |
| R7 | 330k / 0.125W |
| R8* | (Vcc-Vf_led)/If_led |
| C4 | 470nF |
| C5 | 470nF |
| C6 | 100µF |
| C7 | 100nF |
| C9 | Short Circuit |
| C10 | Short Circuit |
| C12 | 1µF |
| D1* | Led 3mm |
| S1, S2, S6, S7 | 2mm insulated Plug 10.16mm pitch |
| S8 | 3 pts connector 2.54mm pitch |
| P1, P2 | PCB Phono Jack |
| U1 | TS4871ID or TS4871IS |

Note on how to use the PSRR curves (page 7)

We have finished a design and we have chosen the components values :

- Rin=Rfeed=22kΩ
- Cin=100nF
- Cb=1μF

Now, on fig. 13, we can see the PSRR (input grounded) vs frequency curves. At 217Hz we have a PSRR value of -36dB.

In reality we want a value about -70dB. So, we need a gain of 34dB !

Now, on fig. 12 we can see the effect of Cb on the PSRR (input grounded) vs. frequency. With Cb=100μF, we can reach the -70dB value.

The process to obtain the final curve (Cb=100μF, Cin=100nF, Rin=Rfeed=22kΩ) is a simple transfer point by point on each frequency of the curve on fig. 13 to the curve on fig. 12. The measurement result is shown on the next figure.

Fig. 85 : PSRR changes with Cb

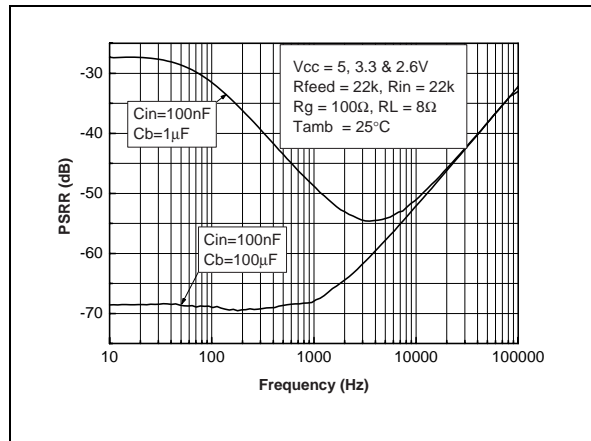

What is the PSRR ?

The PSRR is the Power Supply Rejection Ratio. It's a kind of SVR in a determined frequency range. The PSRR of a device, is the ratio between a power supply disturbance and the result on the output. We can say that the PSRR is the ability of a device to minimize the impact of power supply disturbances to the output.

How do we measure the PSRR ?



Fig. 86 : PSRR measurement schematic

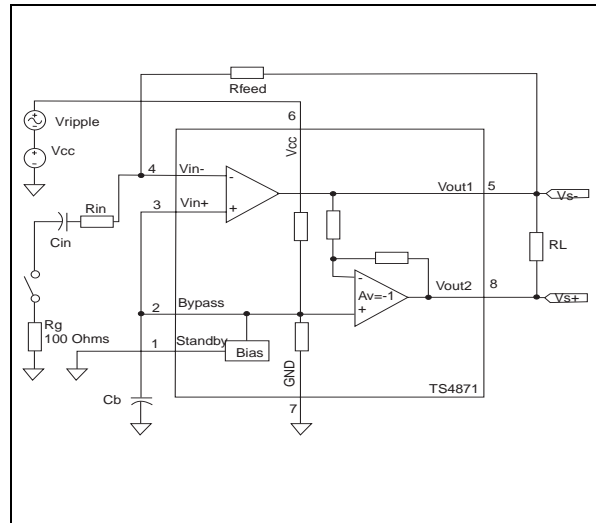

Principle of operation

- We fixed the DC voltage supply (Vcc), the AC sinusoidal ripple voltage (Vripple) and no supply capacitor Cs is used

The PSRR value for each frequency is:

$$PSRR(dB) = 20 \times \text{Log}_{10} \left[\frac{Rms(V_{ripple})}{Rms(Vs_+ - Vs_-)} \right]$$

Remark : The measure of the Rms voltage is not a Rms selective measure but a full range (2 Hz to 125 kHz) Rms measure. It means that we measure the effective Rms signal + the noise.

High/low cut-off frequencies

For their calculation, please check this "Frequency Response Gain vs Cin, & Cfeed" graph:

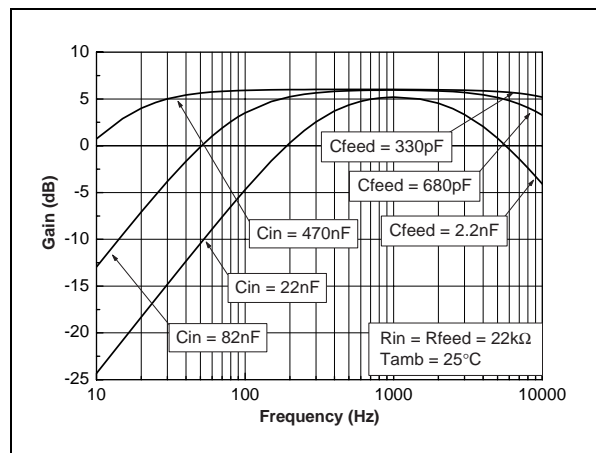

PACKAGE MECHANICAL DATA

SO-8 MECHANICAL DATA

| DIM. | mm. | | | inch | | |
|------|------------------|------|------|-------|-------|-------|
| | MIN. | TYP. | MAX. | MIN. | TYP. | MAX. |
| A | 1.35 | | 1.75 | 0.053 | | 0.069 |
| A1 | 0.10 | | 0.25 | 0.04 | | 0.010 |
| A2 | 1.10 | | 1.65 | 0.043 | | 0.065 |
| B | 0.33 | | 0.51 | 0.013 | | 0.020 |
| C | 0.19 | | 0.25 | 0.007 | | 0.010 |
| D | 4.80 | | 5.00 | 0.189 | | 0.197 |
| E | 3.80 | | 4.00 | 0.150 | | 0.157 |
| e | | 1.27 | | | 0.050 | |
| H | 5.80 | | 6.20 | 0.228 | | 0.244 |
| h | 0.25 | | 0.50 | 0.010 | | 0.020 |
| L | 0.40 | | 1.27 | 0.016 | | 0.050 |
| k | 8° (max.) | | | | | |
| ddd | | | 0.1 | | | 0.04 |

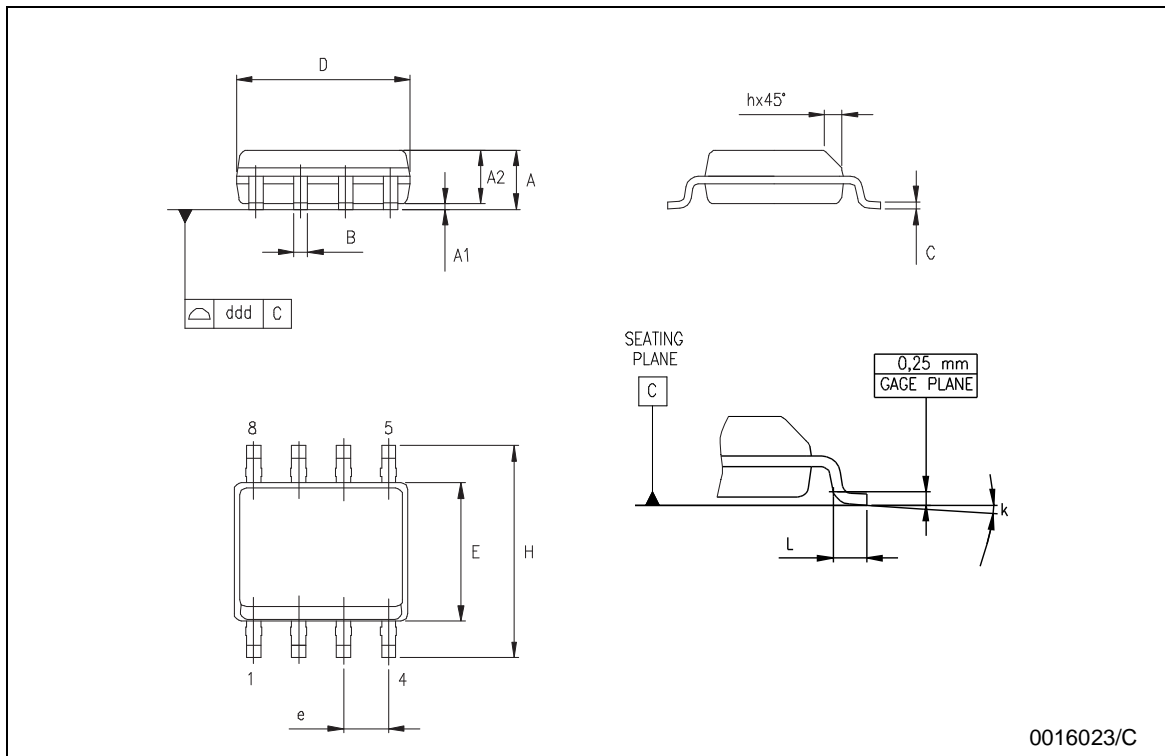

PACKAGE MECHANICAL DATA

miniSO-8 MECHANICAL DATA

| DIM. | mm. | | | inch | | |
|------|------|------|------|-------|-------|-------|
| | MIN. | TYP | MAX. | MIN. | TYP. | MAX. |
| A | | | 1.1 | | | 0.043 |
| A1 | 0.05 | 0.10 | 0.15 | 0.002 | 0.004 | 0.006 |
| A2 | 0.78 | 0.86 | 0.94 | 0.031 | 0.031 | 0.037 |
| b | 0.25 | 0.33 | 0.40 | 0.010 | 0.13 | 0.013 |
| c | 0.13 | 0.18 | 0.23 | 0.005 | 0.007 | 0.009 |
| D | 2.90 | 3.00 | 3.10 | 0.114 | 0.118 | 0.122 |
| E | 4.75 | 4.90 | 5.05 | 0.187 | 0.193 | 0.199 |
| E1 | 2.90 | 3.00 | 3.10 | .0114 | 0.118 | 0.122 |
| e | | 0.65 | | | 0.026 | |
| K | 0° | | 6° | 0° | | 6° |
| L | 0.40 | 0.55 | 0.70 | 0.016 | 0.022 | 0.028 |
| L1 | | | 0.10 | | | 0.004 |

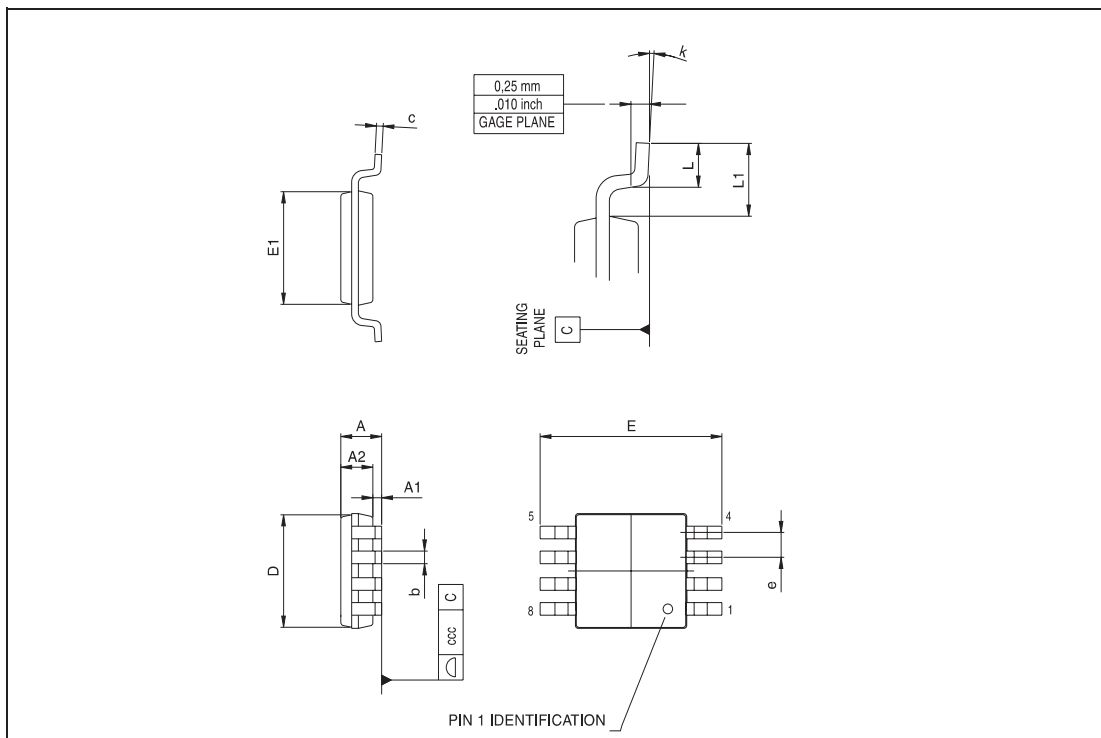

PACKAGE MECHANICAL DATA

| DFN8 (3x3) MECHANICAL DATA | | | | | | |
|----------------------------|------|------|------|------|-------|------|
| DIM. | mm. | | | inch | | |
| | MIN. | TYP | MAX. | MIN. | TYP. | MAX. |
| A | 0.80 | 0.90 | 1.00 | 31.5 | 35.4 | 39.4 |
| A1 | | 0.02 | 0.05 | | 0.8 | 2.0 |
| A2 | | 0.70 | | | 27.6 | |
| A3 | | 0.20 | | | 7.9 | |
| b | 0.18 | 0.23 | 0.30 | 7.1 | 9.1 | 11.8 |
| D | | 3.00 | | | 118.1 | |
| D2 | 2.23 | 2.38 | 2.48 | 87.8 | 93.7 | 97.7 |
| E | | 3.00 | | | 118.1 | |
| E2 | 1.49 | 1.64 | 1.74 | 58.7 | 64.6 | 68.5 |
| e | | 0.50 | | | 19.7 | |
| L | 0.30 | 0.40 | 0.50 | 11.8 | 15.7 | 19.7 |

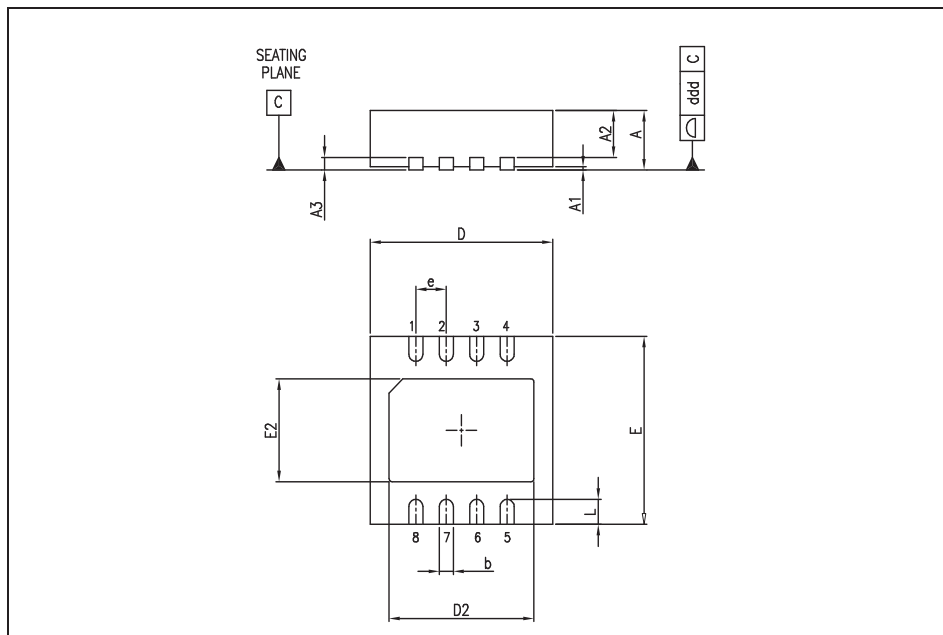

Information furnished is believed to be accurate and reliable. However, STMicroelectronics assumes no responsibility for the consequences of use of such information nor for any infringement of patents or other rights of third parties which may result from its use. No license is granted by implication or otherwise under any patent or patent rights of STMicroelectronics. Specifications mentioned in this publication are subject to change without notice. This publication supersedes and replaces all information previously supplied. STMicroelectronics products are not authorized for use as critical components in life support devices or systems without express written approval of STMicroelectronics.

© The ST logo is a registered trademark of STMicroelectronics

© 2003 STMicroelectronics - Printed in Italy - All Rights Reserved
STMicroelectronics GROUP OF COMPANIES

Australia - Brazil - Canada - China - Finland - France - Germany - Hong Kong - India - Israel - Italy - Japan - Malaysia
Malta - Morocco - Singapore - Spain - Sweden - Switzerland - United Kingdom - United States

© <http://www.st.com>