



---

# BM23 Bluetooth® Evaluation Board User's Guide

## Index

<b>Preface</b> .....	Error! Bookmark not defined.
<b>1 OVERVIEW</b> .....	<b>5</b>
1.1 INTRODUCTION.....	5
1.2 BM23 EVALUATION BOARD FEATURES .....	5
1.3 BM23 EVALUATION BOARD CONTENTS.....	7
<b>2. Getting Started</b> .....	<b>10</b>
2.1 INTRODUCTION.....	10
2.2 HARDWARE REQUIREMENTS .....	10
2.3 APPLICATION DEMONSTRATION .....	10
2.4 SOFTWARE/UTILITY REQUIREMENTS .....	13
2.5 MODULE CONFIGURATION.....	25
<b>APPENDIX A. BM23 AUDIO EVALUATION BOARD SCHEMATICS</b> .....	<b>26</b>
<b>APPENDIX B. CLASS D AMPLIFIER DAUGHTER BOARD</b> .....	<b>37</b>

## PREFACE

### INTRODUCTION

This chapter contains general information that will be useful to know before using the Product Name. Items discussed in this chapter include:

- [Document Layout](#)
- [Recommended Reading](#)
- [The Microchip Web Site](#)
- [Customer Support](#)
- [Document Revision History](#)

### DOCUMENT LAYOUT

This user's guide describes how to use the BM23 Bluetooth Evaluation Board. The document is organized as follows:

- [Chapter 1. "Overview"](#) – This chapter introduces the BM23 Bluetooth Evaluation Board and provides an overview of various features.
- [Chapter 2. "Getting Started"](#) – This chapter describes
  - The hardware components and setup of the BM23 Bluetooth Evaluation Board.
  - The application demonstrations of the BM23 Bluetooth Evaluation Board.
  - Software/Utility Requirements of the BM23 Bluetooth Evaluation Board.
- [Appendix A. "BM23 Audio Evaluation Board Schematics"](#) – This appendix includes a schematic of the BM23 Bluetooth Evaluation Board.

### RECOMMENDED READING

This user's guide describes how to use the BM23 Bluetooth Evaluation Board. Other useful documents are listed below. The following Microchip documents are available and recommended as supplemental reference resources:

STEREO Module Data Sheet (DSxxxxxxx)

### THE MICROCHIP WEB SITE

Microchip provides online support via our web site at <http://www.microchip.com>. This web site is used as a means to make files and information easily available to customers. Accessible by using your favorite Internet browser, the web site contains the following information:

- Product Support – Data sheets and errata, application notes and sample programs, design resources, user's guides and hardware support documents, latest software releases and archived software
- General Technical Support – Frequently Asked Questions (FAQs), technical support requests, online discussion groups, Microchip consultant program member listing
- Business of Microchip – Product selector and ordering guides, latest Microchip press releases, listing of seminars and events, listings of Microchip sales offices, distributors and factory representatives

## **CUSTOMER SUPPORT**

Users of Microchip products can receive assistance through several channels:

- Distributor or Representative
- Local Sales Office
- Field Application Engineer (FAE)
- Technical Support

Customers should contact their distributor, representative or Field Application Engineer (FAE) for support. Local sales offices are also available to help customers. A listing of sales offices and locations is included in the back of this document.

Technical support is available through the web site at: <http://support.microchip.com>

## **DOCUMENT REVISION HISTORY**

Revision A (Aug 2015)

This is the initial released version of this document.

## 1 OVERVIEW

### 1.1 INTRODUCTION

This user's guide describes the hardware and software setup for the BM23 Bluetooth® Evaluation Board. This board contains the hardware needed to evaluate the BM23 Bluetooth module. The BM23 module is mounted to an evaluation board that demonstrates the module's key features. The evaluation board contains:

- PIC18 MCU and YAMAHA YDA174 DSP on board
- 12 push buttons to control audio playback
- Status LEDs
- The BM23 supports the following Bluetooth profiles: A2DP, AVRCP, and HFP/HSP
- A2DP stereo audio (Sink mode support for Sub-Band Coding (SBC)),
- AVRCP media player remote control
- HFP/HSP for accepting a phone call support.

For data sheet and other details related to BM23 module, refer to the Microchip web site at <http://www.microchip.com>.

This chapter discusses the following topics:

- [BM23 Evaluation Board Features](#)
- [BM23 Evaluation Board Contents and Part Details](#)

### 1.2 BM23 EVALUATION BOARD FEATURES

The BM23 Evaluation Board has the following features:

- Fully qualified Bluetooth version 4.1 module, fully compatible with Bluetooth version 3.0, 2.0, 1.2 system.
- Embedded BM23 module with postage-stamp size form factor of 15 x 29 x 2.5 mm (include shielding case)
- Embedded Bluetooth stack profiles: A2DP, AVRCP, and HFP/HSP
- Stereo audio output for highest quality audio
- Castellated SMT pads for easy and reliable PCB mounting
- Environmentally friendly, RoHS compliant
- Bluetooth SIG certified
- Integrate MCU and DSP on board for easy function and feature demonstration.

# BM23 BLUETOOTH EVALUTATION BOARD USER'S GUIDE

---

# BM23 BLUETOOTH EVALUTATION BOARD USER'S GUIDE

## 1.3 BM23 EVALUATION BOARD CONTENTS

BM23 Evaluation Board contains the following components as shown in [Figure 1-1](#) which describes the evaluation board's interfaces and connectors. [Table 1-1](#) describes the various components of the evaluation board.

FIGURE 1-1: BM23 EVALUATION BOARD

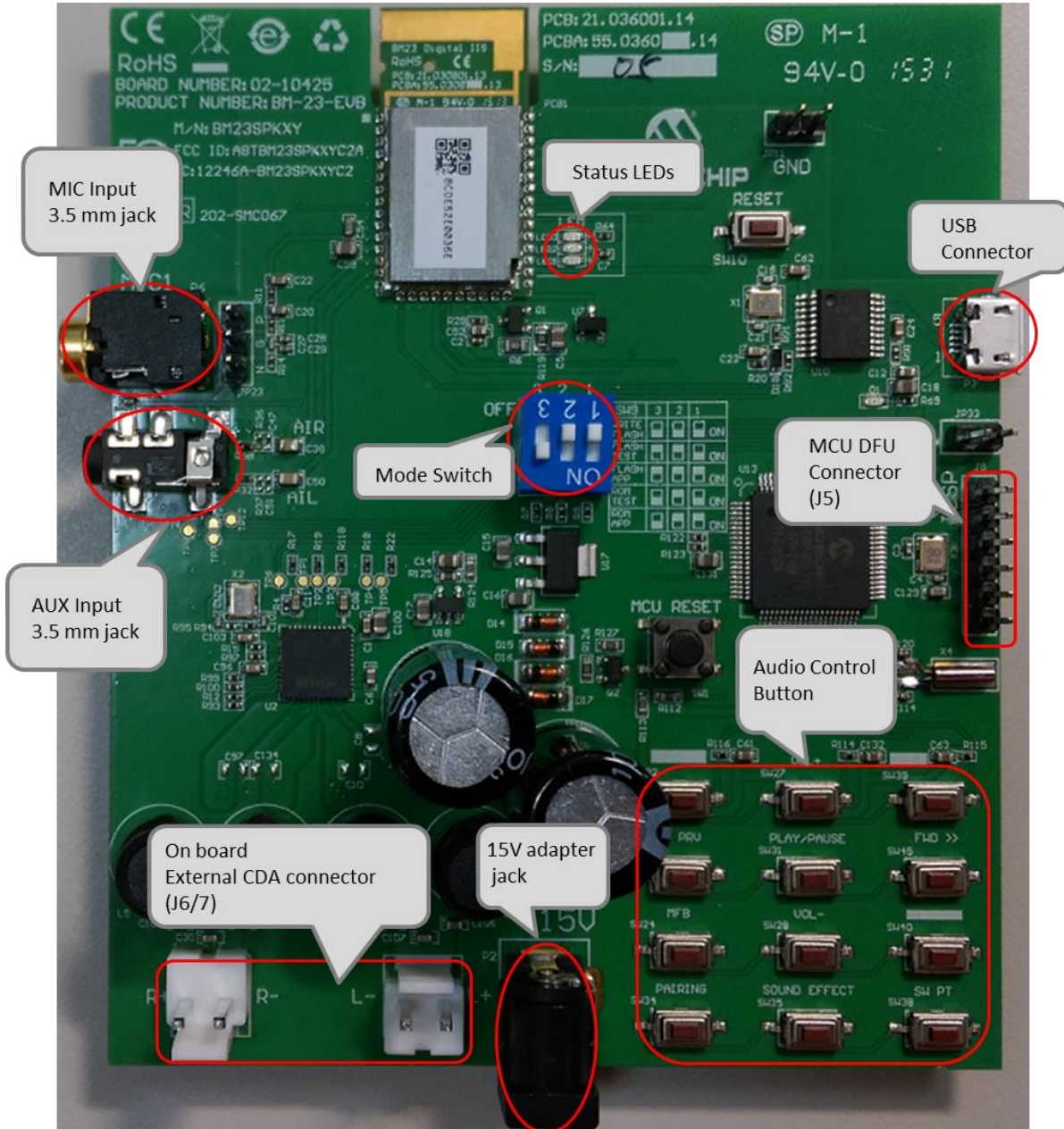

# BM23 BLUETOOTH EVALUTATION BOARD USER'S GUIDE

---

MIC (JP23)



1 2 3

Pin	Description
1	MIC_P1
2	AGND
3	MIC_N1

ICSP (J5)

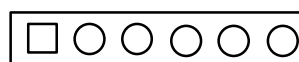

1 2 3 4 5 6

Pin	Description
1	Reset
2	ICD3 power
3	GND
4	PGD
5	PGC
6	NC



# BM23 BLUETOOTH EVALUTATION BOARD USER'S GUIDE

---

TABLE 1-1:BM23 EVALUATION BOARD HARDWARE

Hardware Component	Description
BM23	Bluetooth® 4.1 Module
USB Connector	USB to UART for EEPROM R/W for BM23.
15V Adapter Jack	Connect to 15V adapter (P2) for main power source of whole system.
Amplifier Audio Out	External AMP Connector JP6 / 7
Audio In	Audio 3.5 mm jack for Mono microphone input(P6) and AUX input(P8)
Status LEDs	Red and Blue LEDs show the pairing/connection status
MFB Button	Switch to turn on/off BM23 module (SW24)
Play/Pause Button	Button to play or pause the audio playback (SW31)
Previous Track Button	Button to skip track backwards (SW23)
Next Track Button	Button to skip track forwards(SW45)
Volume Up Button	Button to increase volume (SW27)
Volume Down Button	Button to decrease volume (SW28)
Reset Button	Reset BM23 (SW10); Reset MCU (SW1)

## 2. Getting Started

### 2.1 INTRODUCTION

This chapter describes how the BM23 Evaluation Board works. Certain hardware and utilities are essential to support the evaluation/development of demo applications. This chapter discusses the following topics:

- Hardware Requirements
- Software/Utility Requirements
- Module Configuration

### 2.2 HARDWARE REQUIREMENTS

#### 2.2.1 HARDWARE SETUP

To setup the evaluation hardware, perform the following steps:

1. Make sure pin 1 / 2 / 3 of “SW9” in “Off / Off / On” state make .system in application mode.

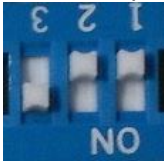

2. Connect the speaker line to the amplifier output connector (J6 / 7).

#### 2.2.2 USING THE EVALUATION BOARD

1. Connect 15V adapter P2.
2. Click MFB button to turn-on and enter pairing mode. The status LEDs will blink. Now the BM23 Evaluation board should be discoverable.
3. Turn on Bluetooth device manager on a host device (PC or smartphone), the host device will display a list of discoverable Bluetooth devices. Select the device and connect with it.
4. If the pairing with the device is successful, BM23 evaluation board can connect to the host device. Once connected, BM23 evaluation board enables Advanced Audio Distribution Profile (A2DP) for audio playback and Audio Video Remote Control Profile (AVRCP) for player control.

### 2.3 APPLICATION DEMONSTRATION

#### 2.3.1 AUDIO DEMONSTRATION

In this demonstration, user can play an audio stream on both BM23 evaluation boards using a computer or smartphone. The following are the steps to perform the demonstration.

1. Connect BM23 evaluation board to a host device (PC or smartphone) that has an audio source.
2. Connect speakers to BM23 evaluation board J6 / 7.
3. Open the audio source on the host device. Microchip recommends using media player.(e.g. Microsoft Media Player, iTunes, and Android).
4. Start the audio stream on the media player.

When BM23 evaluation board is connected to an audio source compatible with Bluetooth AVRCP, the audio control buttons are use to:

- Control the volume of audio output.
- Go to the previous track.

# BM23 BLUETOOTH EVALUTATION BOARD USER'S GUIDE

- Go to the next track.
- Start / stop playing the current track.

FIGURE 1-2: BM23 EVALUATION BOARD AUDIO CONTROL BUTTONS

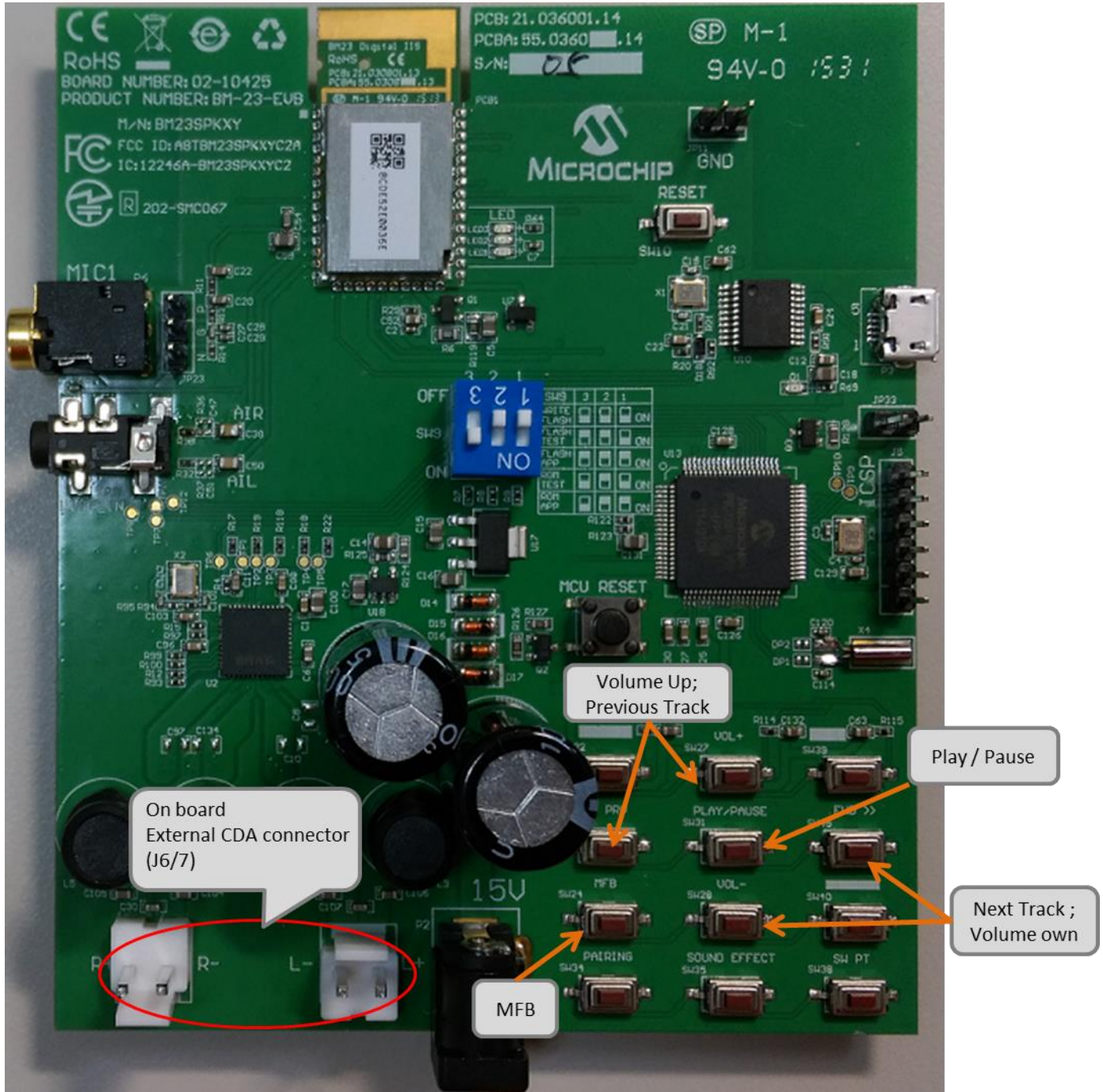

## 2.3.2 HSP/HFP DEMONSTRATION

In this demonstration, user can explore the hands-free profile setting to receive an incoming voice call from a paired smartphone. This demonstration requires a microphone. It would be good to use a PC headset/microphone (with two-plugs). The following are the steps to perform the demonstration.

1. Connect the speakers / microphone to BM23 evaluation board's audio out connector (J6/7) and MIC input (P6) respectively.
2. Connect BM23 evaluation board to a smartphone that supports the A2DP and HFP/HSP Bluetooth profiles.
3. From another one phone, initiate a call to the smartphone that is paired with BM23 evaluation board. The A2DP stream pauses and the ringtone plays on the speakers.
4. Click button "MFB" on BM23 evaluation board to accept the incoming call.

## 2.4 SOFTWARE/UTILITY REQUIREMENTS

### 2.4.1 UI SETTING

Step1. Open UI tool

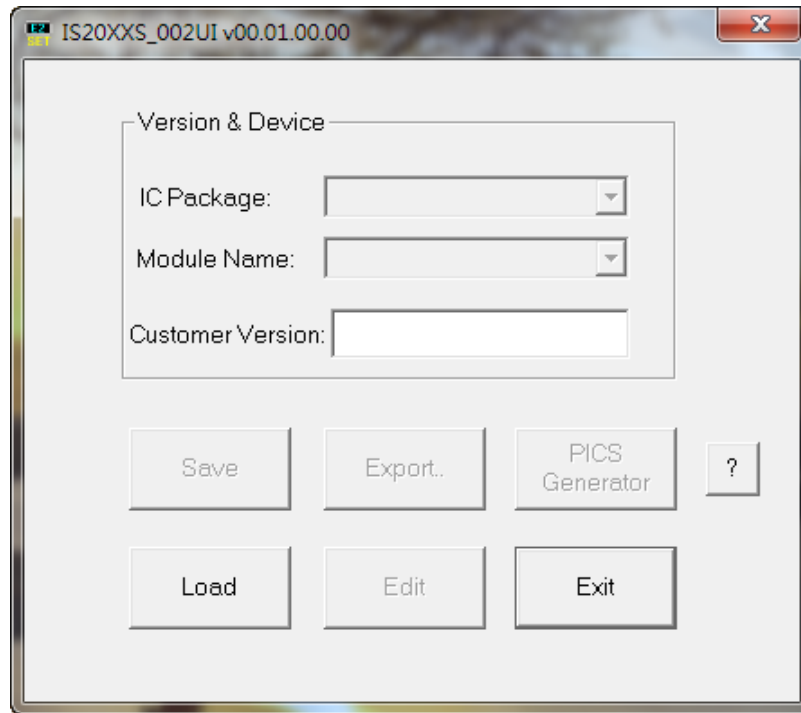

Step2. Firstly, you can load default UI setting or previous setting file.

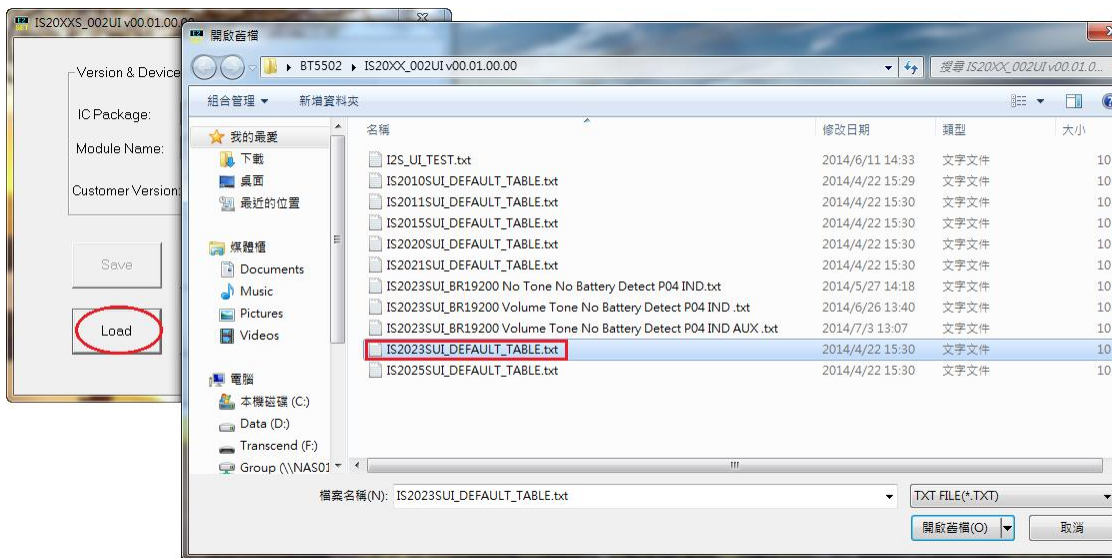

# BM23 BLUETOOTH EVALUTATION BOARD USER'S GUIDE

**Step3.** Click "Edit" to modify the settings meet your needs.

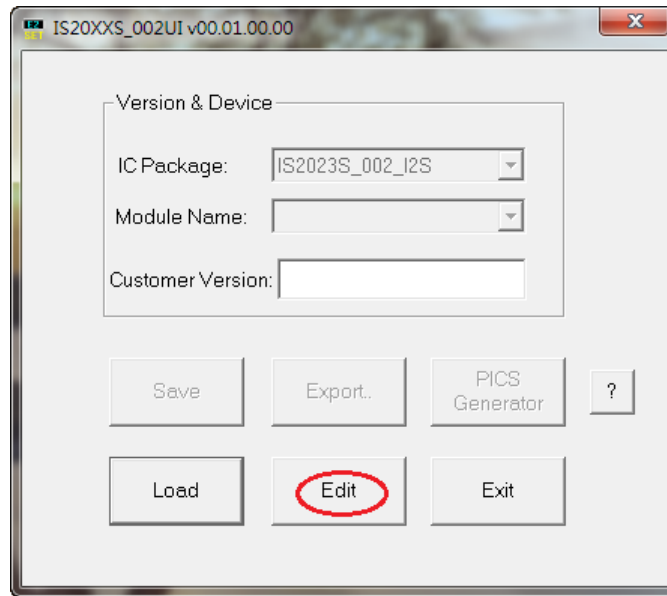

**Step4.** In the main settings, it can enable or disable supported profile or function which system need.  
Click "Next" for other setting.

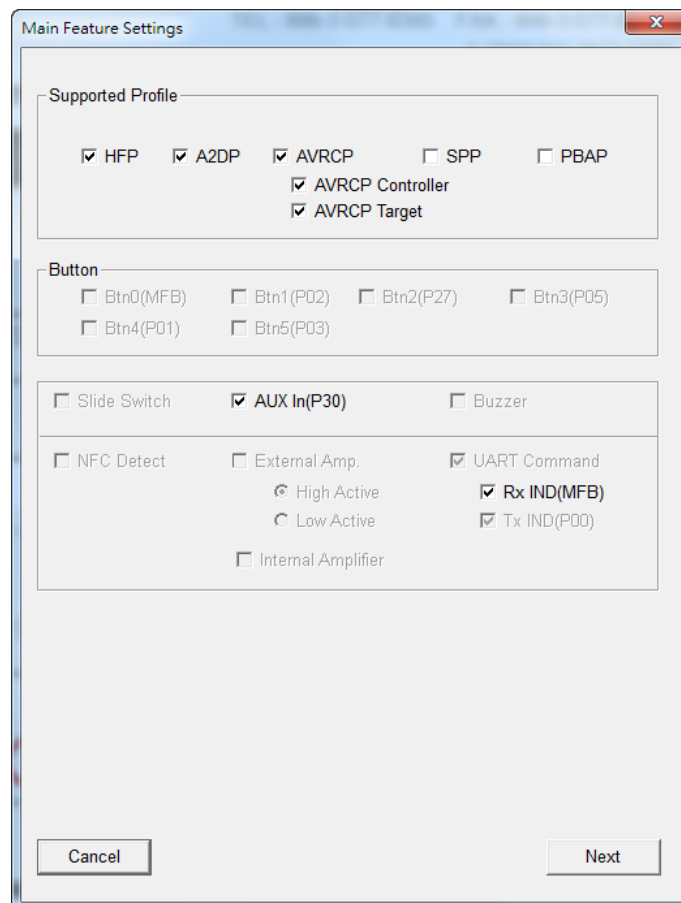

# BM23 BLUETOOTH EVALUTATION BOARD USER'S GUIDE

**Step5.** You can do system and functional setting in these pages.

Click “Help” you can get more detail information.

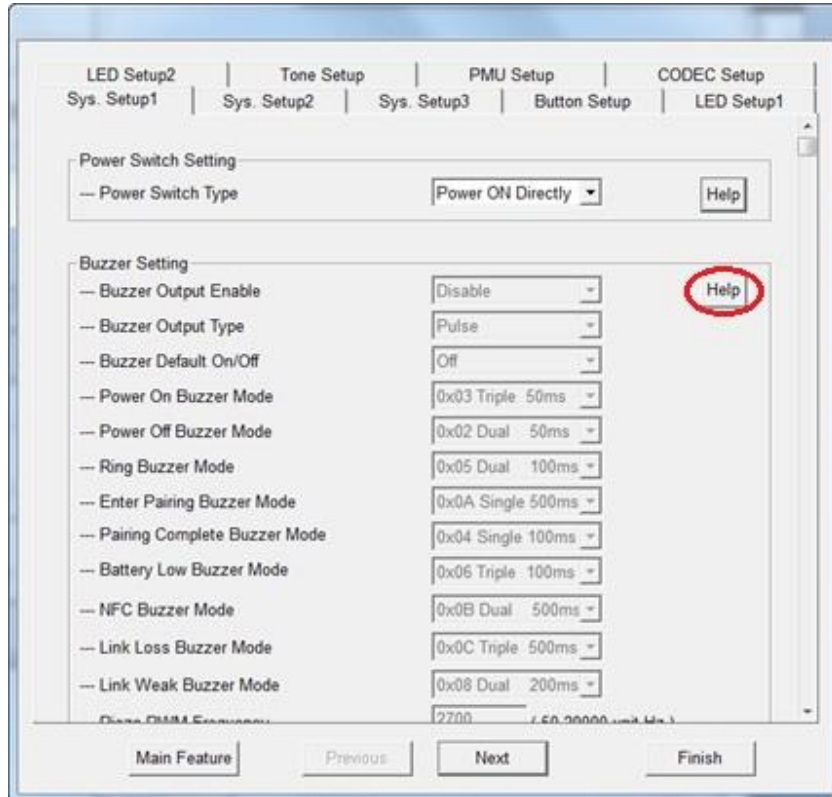

**Step6.** After finish parameter set up, click “Finish” button and a message will remind you check EEPROM size on your system.

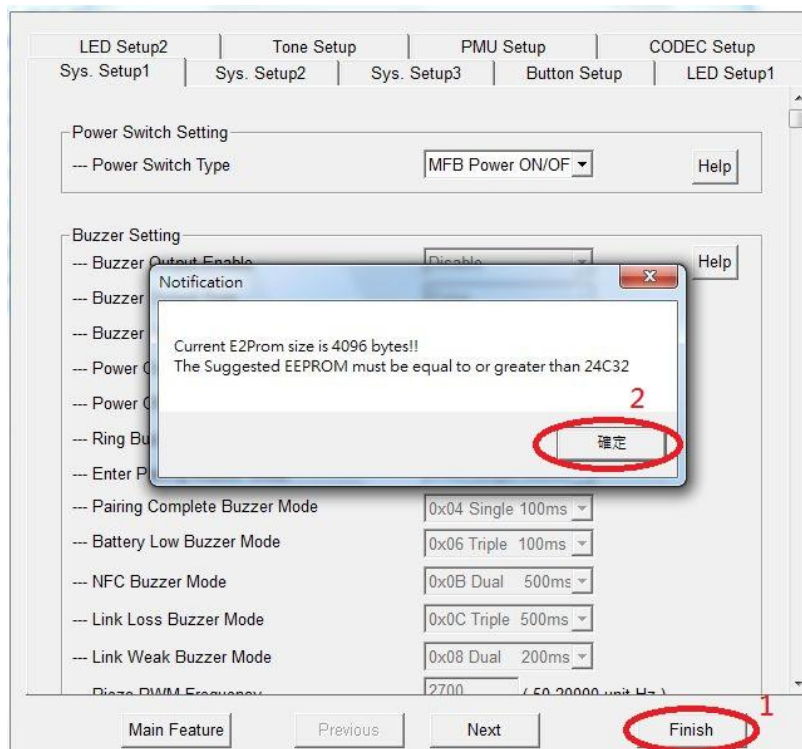

**Step7.** Click "Save" button to save these UI parameter as a ".txt" file

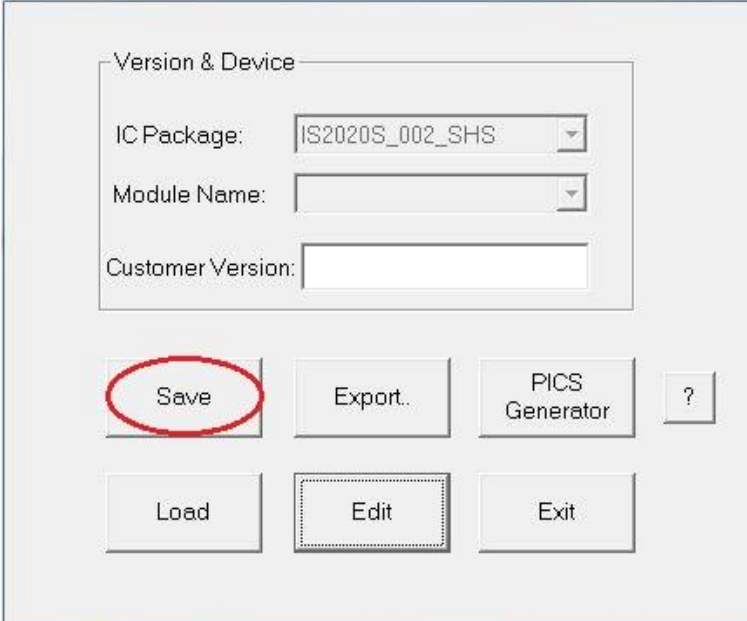

The screenshot shows a software window titled "Version & Device" with the following fields and buttons:

- IC Package: IS2020S\_002\_SHS (dropdown menu)
- Module Name: (dropdown menu)
- Customer Version: (text input field)
- Buttons: Save (circled in red), Export., PICS Generator, ? (help icon), Load, Edit, Exit

**Step8.** We will use MPET tool to merge it with EEPROM table and use EEPROM tool load these parameter to system.



## 2.4.2 DSP TOOL SETTING

**Step1.** Open DSP tool

**Step2.** Select IC version “IS2020\_XXX\_SHS” (XXX is the version of chip, e.g. IS2020S-203)



**Step3.** You can setup all voice and audio function in these pages.

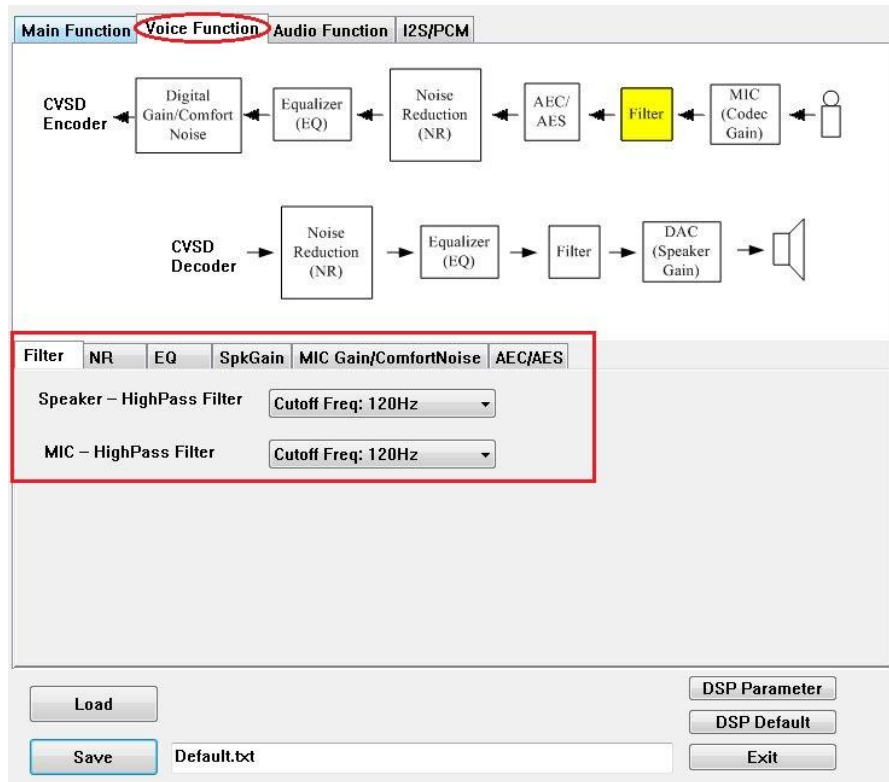

**Step4.** Click “Save” button to save these DSP parameter as a “.txt” file after finish all DSP setting. Then use MPET tool to merge it with EEPROM table and use EEPROM tool load these parameter to system.

The screenshot displays the software interface for the BM23 Bluetooth Evaluation Board. At the top, there are four tabs: "Main Function", "Voice Function", "Audio Function" (which is circled in red), and "I2S/PCM". Below the tabs is a block diagram of the audio processing pipeline. It starts with "Audio Input" entering a yellow box labeled "LineIn". From "LineIn", the signal goes to an "SBC/AAC Decoder". The output of the decoder branches: one path goes to "Audio Effect", and another path goes to "Equalizer (EQ)". The output of "Audio Effect" also goes to "Equalizer (EQ)". The output of "Equalizer (EQ)" goes to "DAC (Speaker Gain)", which is connected to a speaker icon. Below the diagram is a settings panel with a red border. It has four sub-tabs: "LineIn" (selected), "SPK Gain", "Sound Effect", and "EQ". Under the "LineIn" tab, there are five settings, each with a dropdown menu:

- Silence Detection Threshold: 0x1A:-84dB0v
- Initial LineIn SPK Gain: 0x0A
- LineIn MaxLevel: F
- LineIn MinLevel: 0
- LineIn ADC Gain: -6dB, 0x00

At the bottom of the interface, there are several buttons: "Load", "Save" (circled in red), "DSP Parameter", "DSP Default", and "Exit". A text field next to the "Save" button contains the filename "Default.txt".

### 2.4.3 MERGE TOOL SETTING

**Step1.** Open MPET tool, click "Next" to set up.



**Step2.** Select "UI Patch Only" to use full EEPROM table to merge UI and DSP parameter.

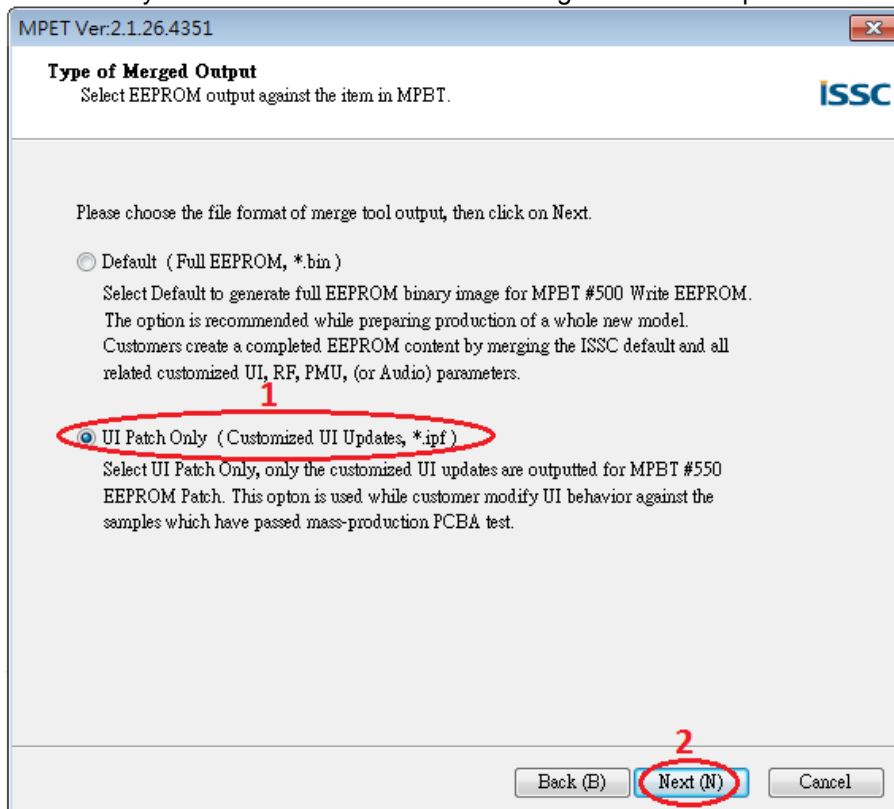

# BM23 BLUETOOTH EVALUTATION BOARD USER'S GUIDE

**Step3.** Select the bin file (full EEPROM table) and click “Next”

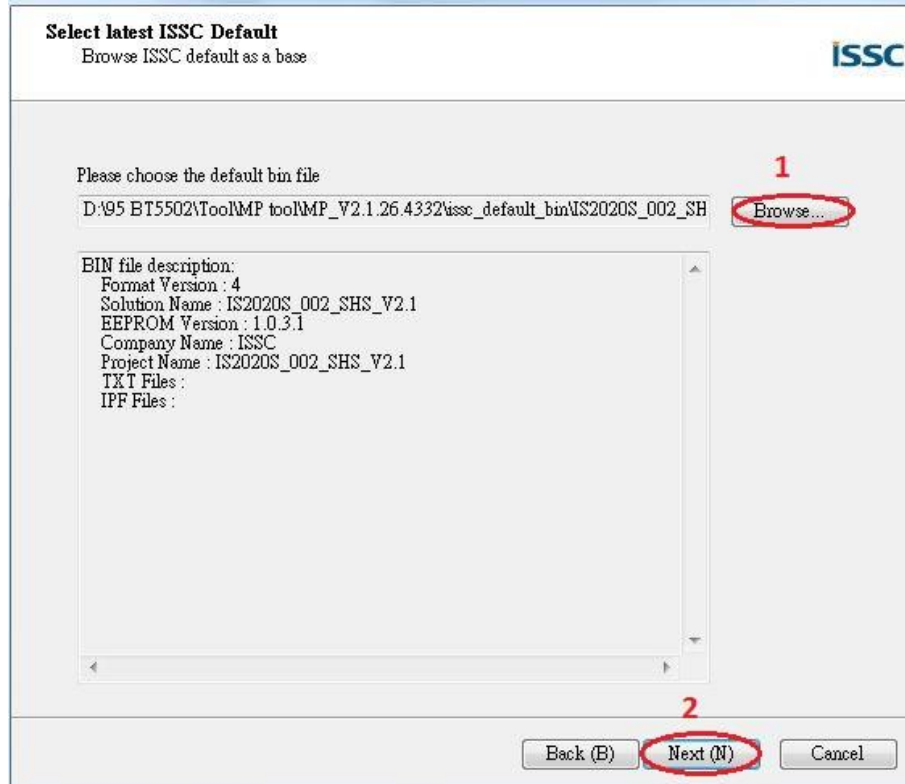

**Step4.** If the bin file had included UI, DSP or patch code parameter, you can see them in block 1 as the figure below. If you want keep the in your new system, you can select the item which you want to keep and use “pull down” button to add them to merge list. If you want to add new parameter (e.g. UI and DSP parameter), click “+” button to add these files into tool for merge with EEPROM table.

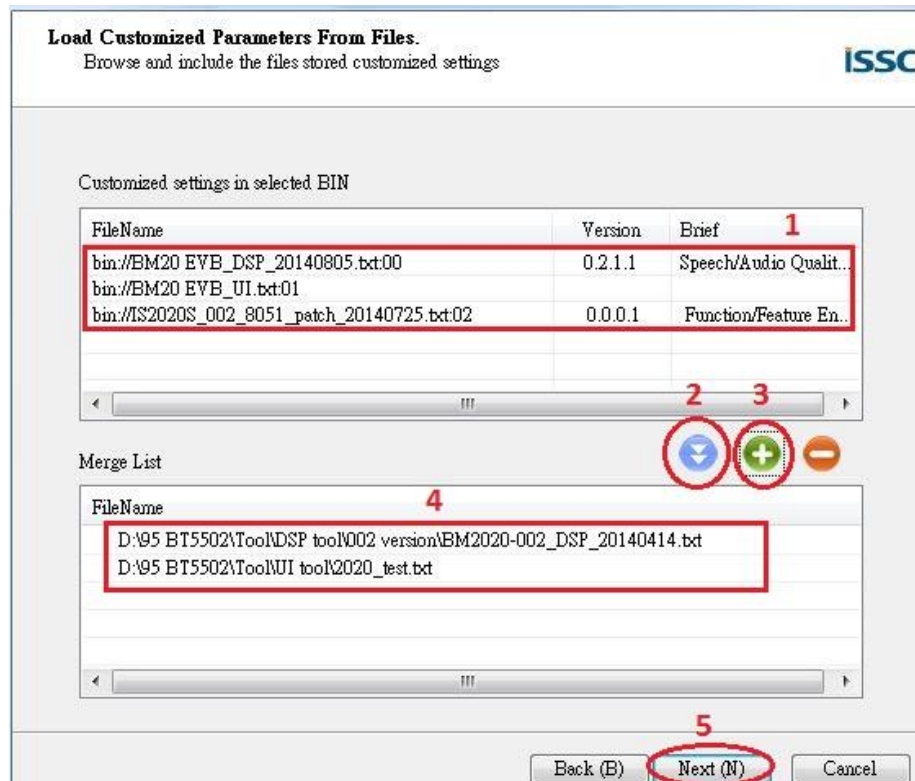

**Step5.** Select an output path and create a name for the merged EEPROM table.

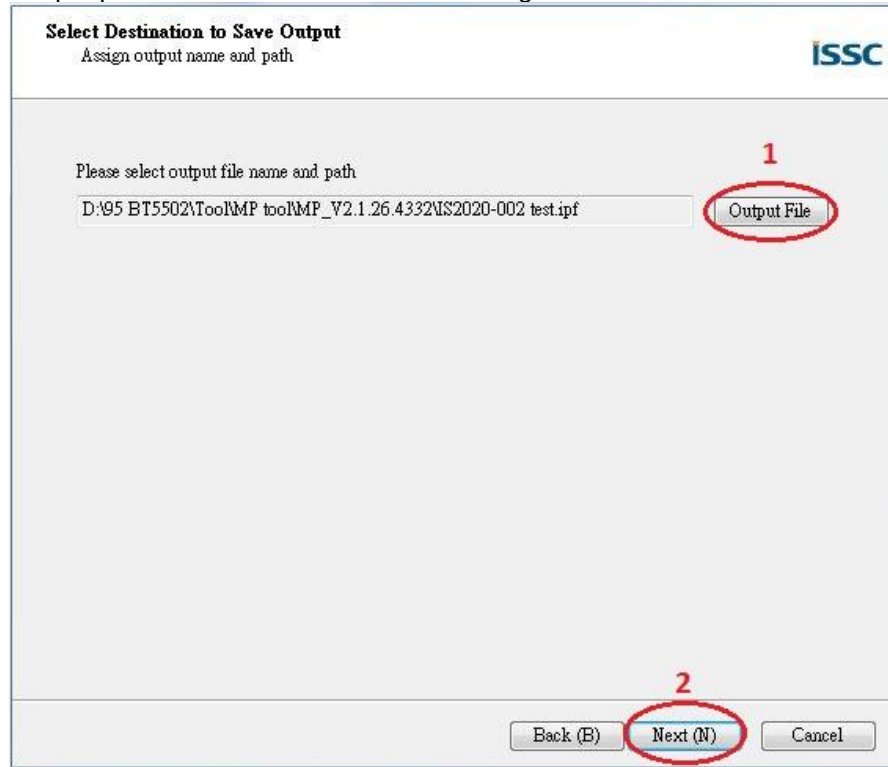

**Step6.** Click "Generate" button to generate the new EEPROM table.

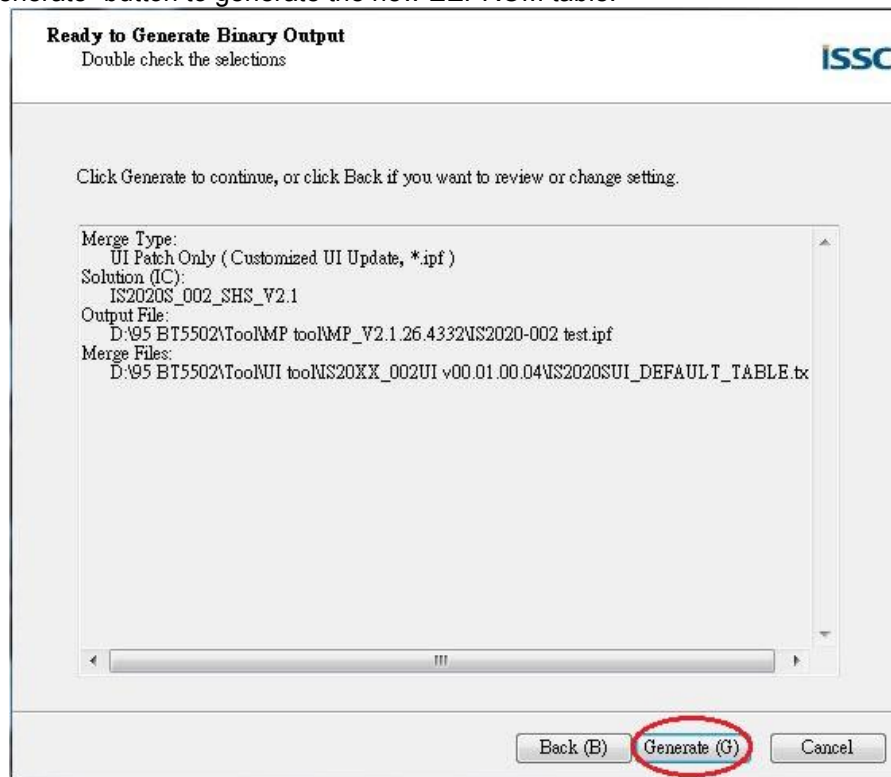

**Step7.** Select if you want use new setting of these parts.

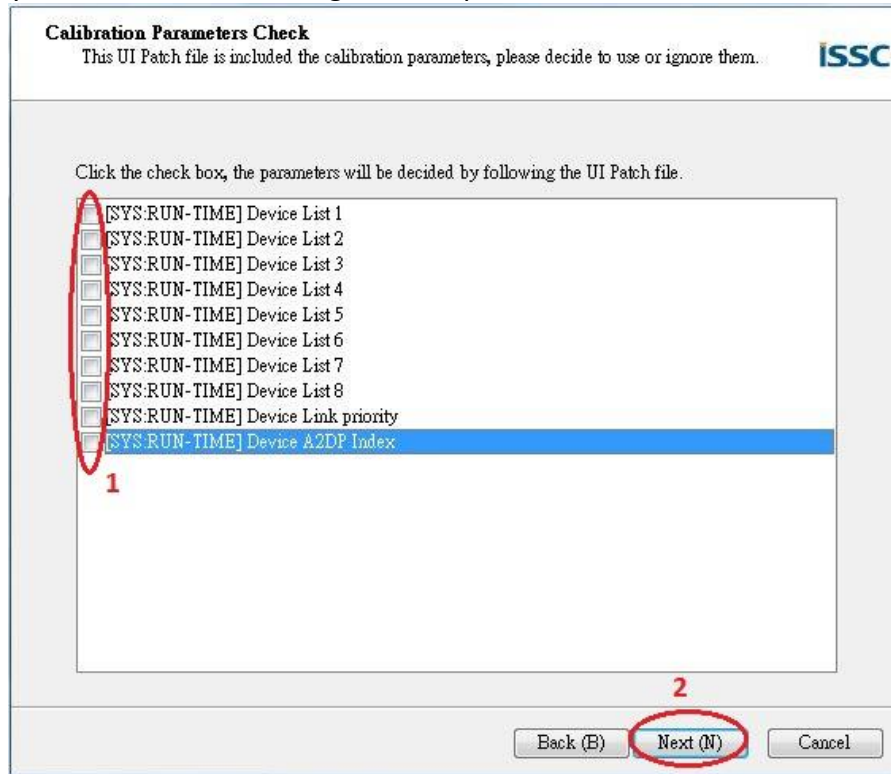

**Step8.** Now you have a merged patch file (\*.ipf file).



## 2.4.4 Procedure to Update EEPROM Parameters



**Step 1.** Make sure SW9 in “ROM TEST” mode.

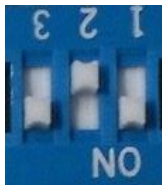

**Step 2.** Connect EVB “P1” port and PC by USB cable. **LED1** & **LED2** on EVB will keep lighting.

**Step 3.** Run the **E2PROM\_tool.exe** program and a window will be come up as below

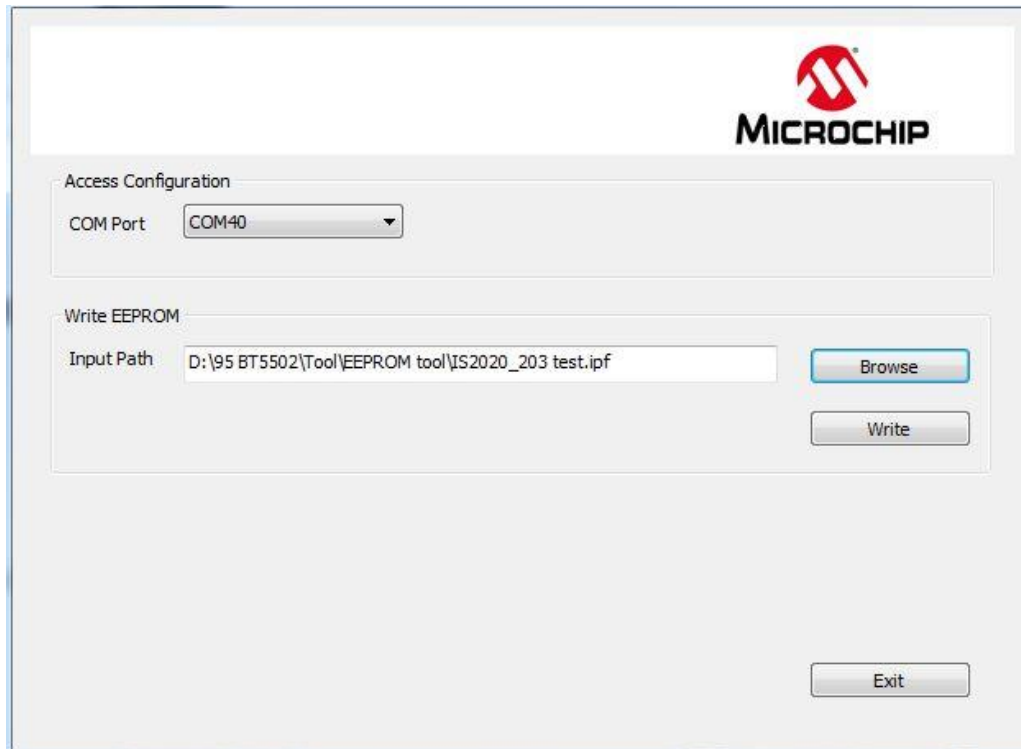

**Step 4.** Specify the **COM** Port.

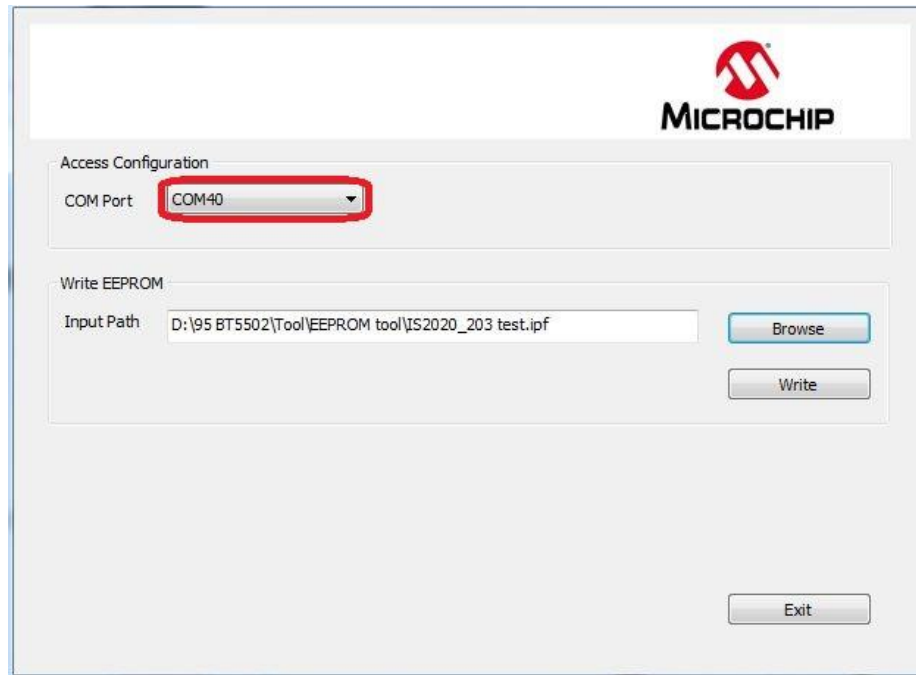

**Step5.** Press "Browse" to choose the file where you want to write EEPROM table or patch file.

**Step6.** Press "Write" to write these setting to EEPROM

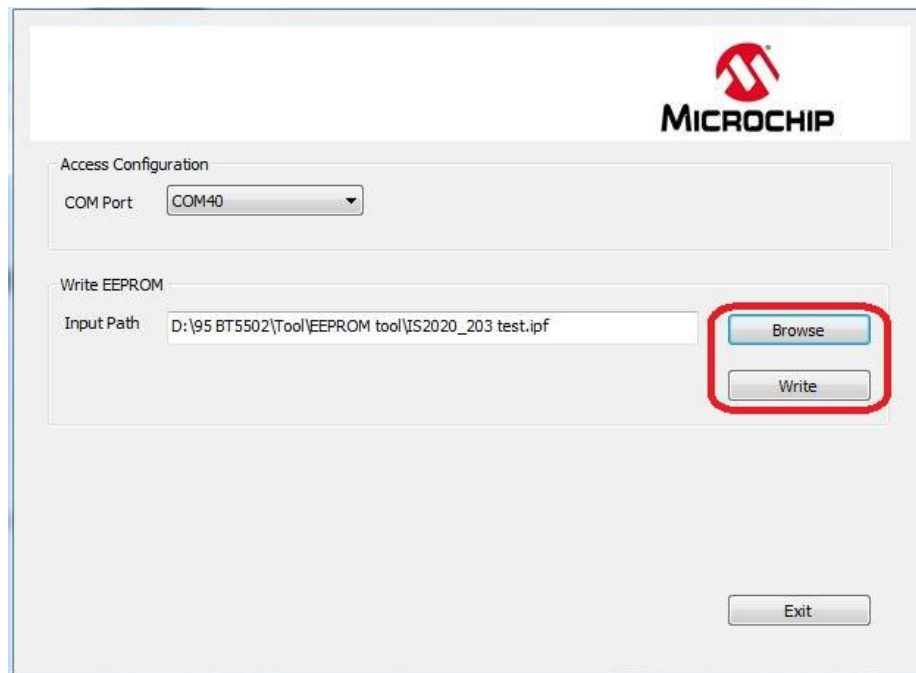

**Step7.** After finish data update, remove USB cable and make SW9 to "ROM APP" mode and reboot.

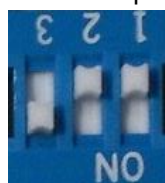

Now EVB can use the new setting after updated EEPROM parameter.



## 2.5 MODULE CONFIGURATION

### 2.5.1 Mode Settings

Setting in Mode Switch:

For ROM chip application

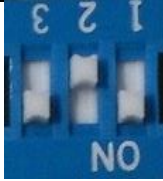
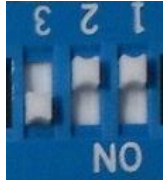
Mode	SW9 Setting	Switch 9 PIN Definition
Test Mode		1: ON (P2_0: LOW) 2: OFF (P2_4: HIGH) 3: ON (EAN: HIGH)
Application Mode		1: OFF (P2_0: HIGH) 2: OFF (P2_4: HIGH) 3: ON (EAN: HIGH)

**APPENDIX A. BM23 AUDIO EVALUATION BOARD SCHEMATICS**

EVB block diagram

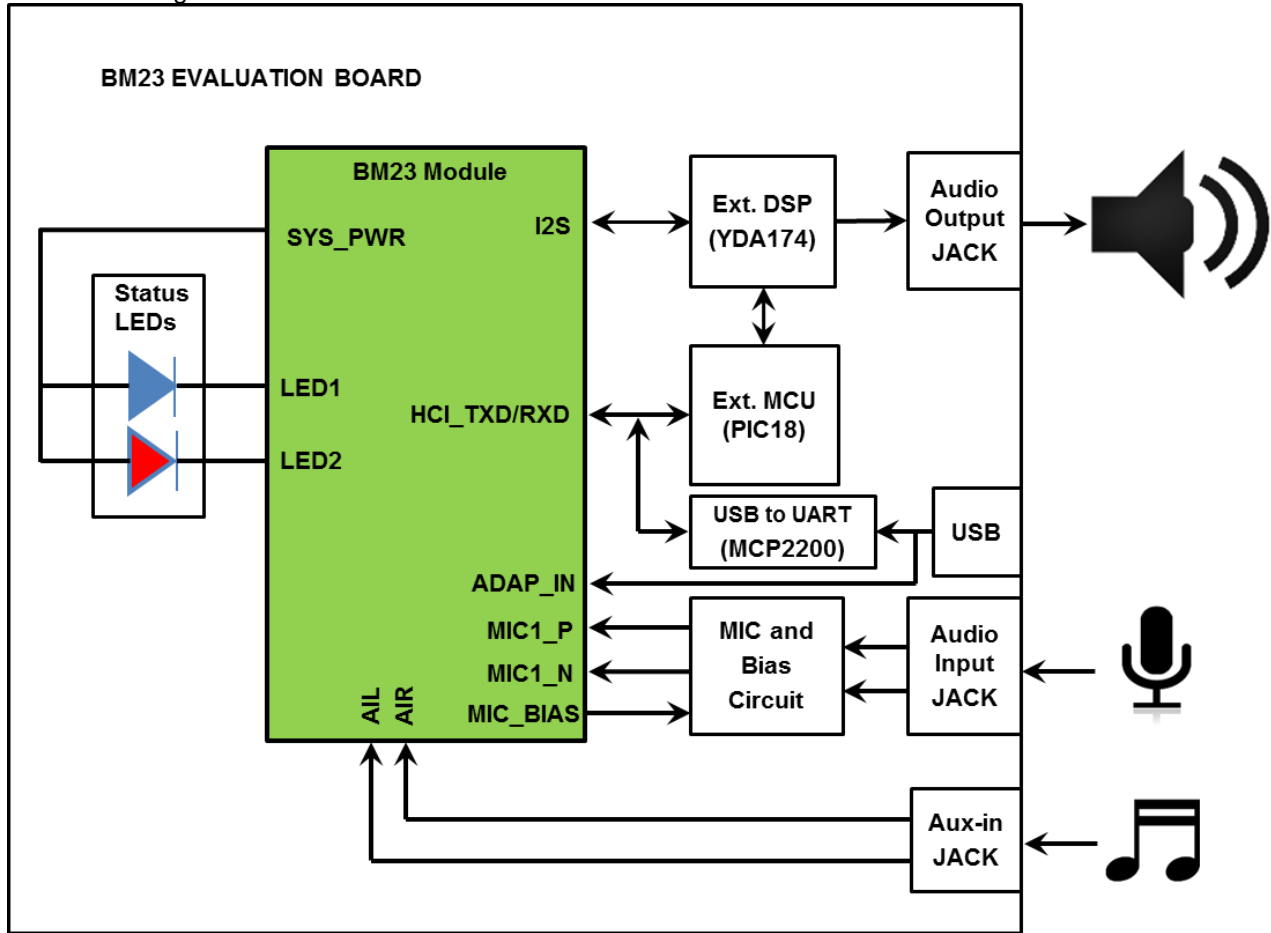







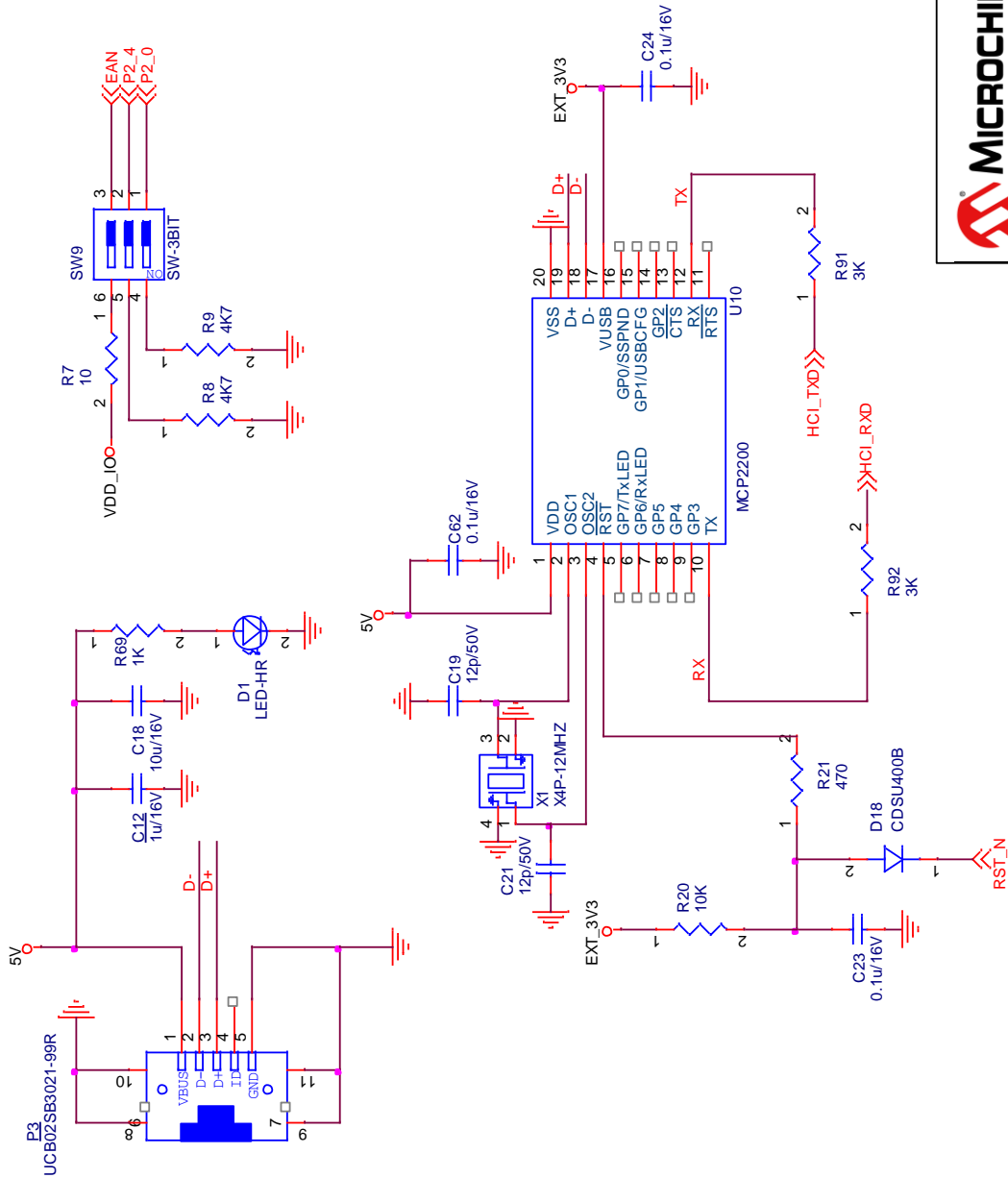

# BM23 BLUETOOTH EVALUTATION BOARD USER'S GUIDE



		5F, No.5, Industry E. Rd. VII, Hsinchu Science Park Hsinchu City 30078, Taiwan TEL: 886-3-5778385	
		<b>Board Name</b> BM23 EVB	<b>P/N</b> 0360
<b>Size</b> A	<b>Title</b> HCI INTERFACE	<b>Rev</b> 4.0	<b>Date:</b> Wednesday, July 22, 2015
		Sheet 5 of 8	







# BM23 BLUETOOTH EVALUTATION BOARD USER'S GUIDE

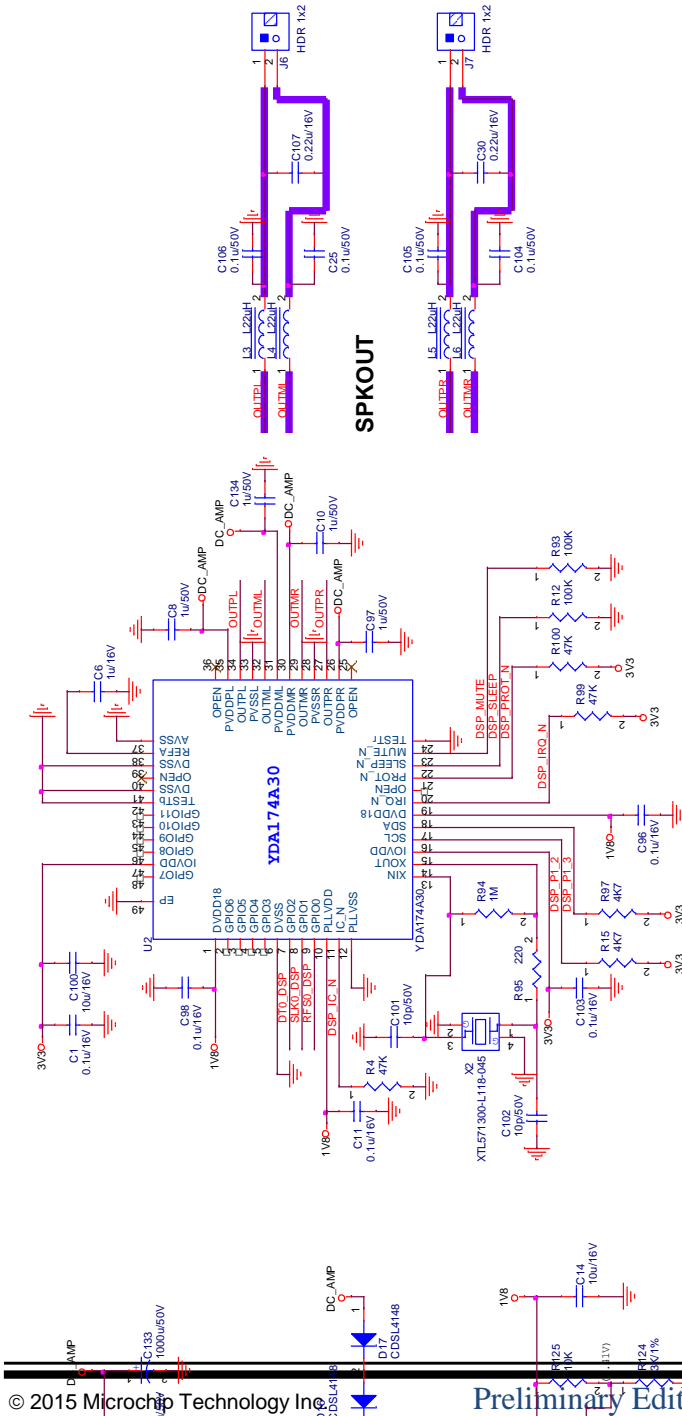

## I2S INTERFACE



## INTERFACE



		5F, No.5, Industry E. Rd. VIII, Hsinchu Science Park Hsinchu City 30078, Taiwan TEL: 886-3-578986	
Board Name	BM23 EVB	P/N	0360
Title	DSP_YDA174	Rev	4.0
Size	B	Date	Microchip, July 22, 2015
		Sheet	6 of 8







# BM23 BLUETOOTH EVALUTATION BOARD USER'S GUIDE

## BUTTON

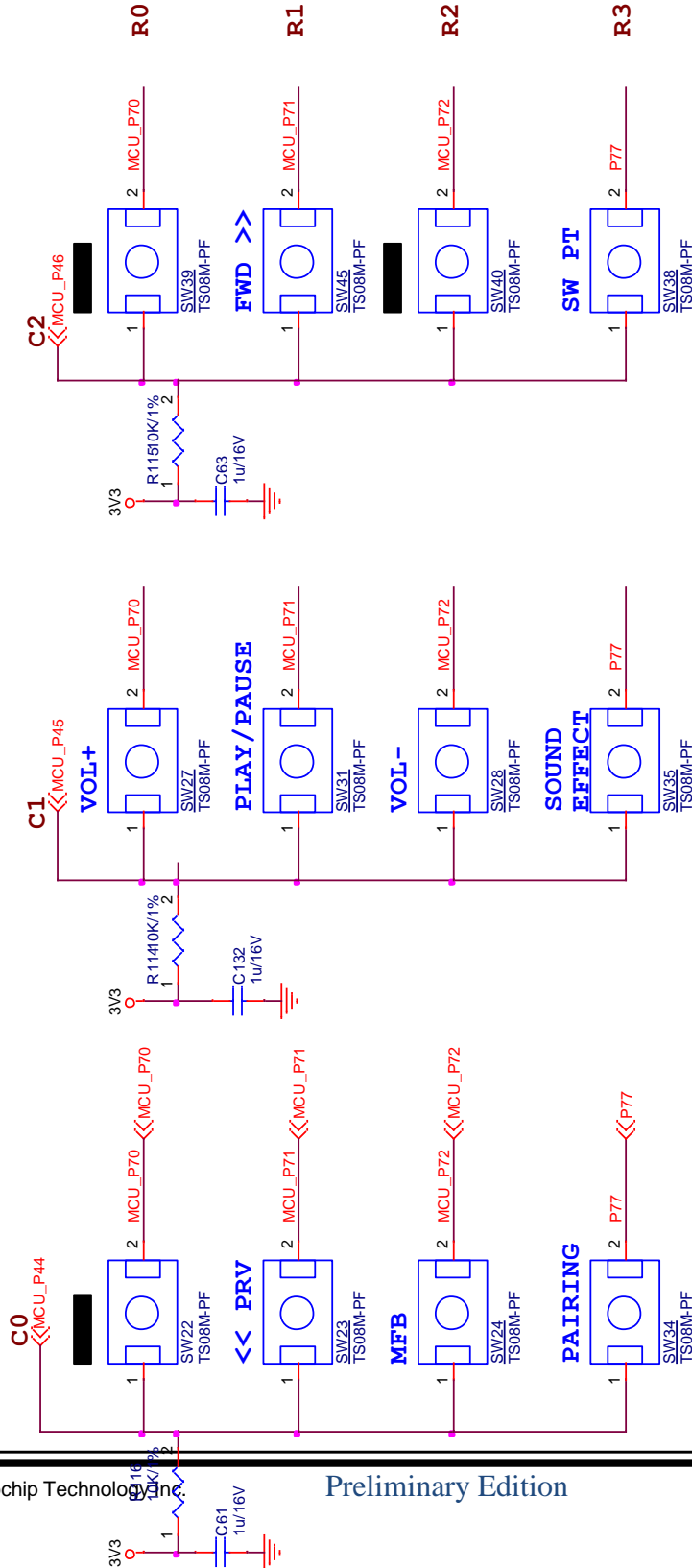

		5F, No.5, Industry E. Rd. VII, Hsinchu Science Park Hsinchu City, 30078, Taiwan TEL: 886-3-5778385			
		Board Name	BM23 EVB	P/N	0360
Size	A	Title	MCU_BUTTON	Rev	4.0
Date:	Monday, July 27, 2015	Sheet	8	of	8

