

APPROVAL SHEET

承認書

Customer 客戶名稱	
Part No. 產品型號	TVL-55738GD032J-LW-G-AAN
Product type 產品內容	Mode: Transmissive and Normally white type 3.2" a-Si TFT LCD Module
RoHS 綠色產品	<input type="checkbox"/> Non-compliance <input checked="" type="checkbox"/> Compliance
Remarks 備註欄	
<p> <input checked="" type="checkbox"/> Preliminary Specification 暫行規格 <input type="checkbox"/> Final Specification 正式規格 </p> <p>Signature by Customer: 客戶確認簽章:</p>	

Issued by QA	Checked by QA	Checked by PM	Approved By	
			QA	RD

Specification of LCD Module

Product No.: TVL-55738GD032J-LW-G-AAN

Issue date: 2012/04/24

KYOCERA DISPLAY CORPORATION

5-7-18, Higashinipori Arakawa-ku ,
Tokyo 116-0014, Japan
TEL: +81-3-5811-8780
FAX: +81-3-5811-8782



KYOCERA Display Corporation

TABLE OF CONTENTS

1. GENERAL DESCRIPTION	5
2. FEATURES	5
3. MECHANICAL SPECIFICATION.....	5
4. MECHANICAL DIMENSION.....	6
5. MAXIMUM RATINGS.....	7
6. ELECTRICAL CHARACTERISTIC.....	7
7. BACKLIGHT CHARACETRISTIC	8
8. MODULE FUNCTION DESCRIPTION.....	9
8.1. Pin Description	9
8.2. Timing Characteristics	11
8.3. Serial Peripheral Interface (Spi).....	12
8.4. Block diagram of LCM	13
9. ELECTRO-OPTICAL CHARACTERISTICS	15
10. RELIABILITY	17
10.1. MTTF	17
10.2. Tests	17
10.3. Color performance.....	17
11. INSPECTION CRITERIA.....	18
11.1. Inspection Conditions	18
11.2. Light Method.....	18
11.3. Classification Of Defects	19
11.4. Sampling & Acceptable Quality Level.....	19
11.5. Definition Of Inspection Area.....	19
11.6. Items and Criteria	20
12. ILLUSTRATION OF LCD DATE CODE.....	22



KYOCERA Display Corporation

13. RoHS COMPLIANT WARRANTY	23
14. PRECAUTIONS FOR USE	23
14.1. Safety	23
14.2. Storage Conditions	23
14.3. Installing LCD Module	23
14.4. Precautions For Operation	24
14.5. Handling Precautions	24
14.6. Warranty	24
15. REVISION HISTORY	25

KYD Confidential Document/Preliminary



KYOCERA Display Corporation

1. GENERAL DESCRIPTION

TVL-55738GD032J-LW-G-AAN is a transmissive type color active matrix liquid crystal display (LCD), which uses amorphous thin film transistor (TFT) as switching devices. This product is composed of a TFT LCD panel, driver IC, and FPC, backlight unit.

2. FEATURES

Display Mode	Transmissive Type
	a-Si color TFT LCD, Normally white type
Screen Size	3.2 inches
Display Format	Graphic 320*RGB*240 Stripe type
Color Depth	16.7M colors
Input Data	24-bit Parallel RGB with SPI (3 wires) control interface
Viewing Direction	Higher Contrast ratio: 6 o'clock Less gray scale reversal: 12 o'clock
Backlight	White LED
Driver IC	ILI9322B

3. MECHANICAL SPECIFICATION

Item	Specifications	Unit
Dimensional outline	70.36(W) × 58.96(H) × 3.3(D)*	mm
Resolution	320 × RGB × 240	Pixel
Active area	65.04(W) × 48.78(H)	mm
Pixel pitch	0.20325(W) × 0.20325(H)**	mm
Dots pitch	0.6775(W) × 0.20325(H)	mm

*Note: Not Including FPC length.

**Note: 1 pixel = 3 dots = Red dot +Green dot +Blue dot.

4. MECHANICAL DIMENSION

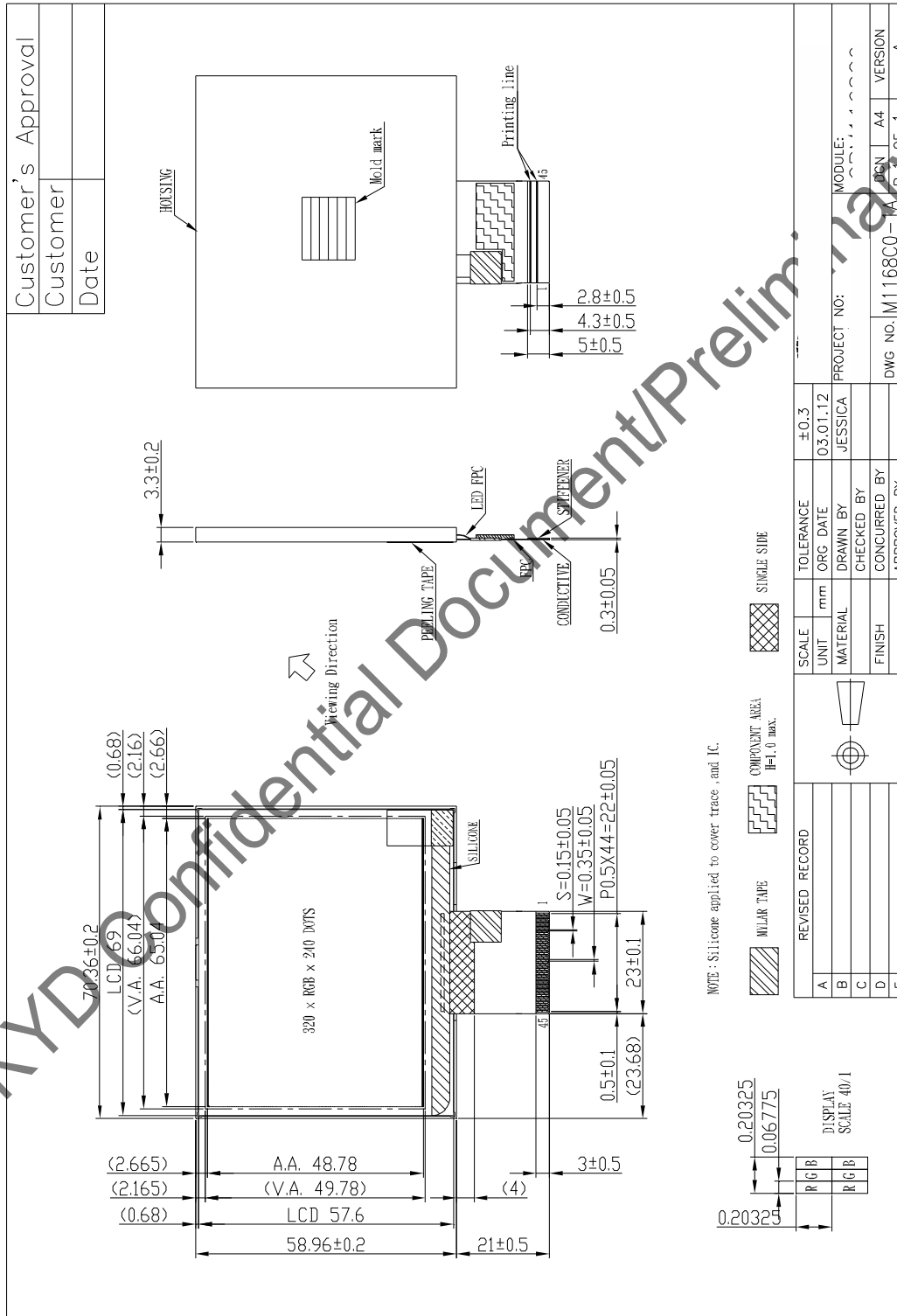

5. MAXIMUM RATINGS

If the operating condition exceeds the following absolute maximum ratings, the TFT LCD module may be damaged permanently.

Items	Symbol	Condition	Min.	Max.	Unit	Note
Power Voltage	VCI	AGND=0	-0.3	4.6	Volt	
	VDD	GND=0	-0.3	4.6	Volt	
Operating Temperature	Top	-	-20	70	°C	Ambient temperature
Storage Temperature	Tst	-	-30	80	°C	Ambient temperature
Humidity	-	-	-	90	%RH	

Note :

- 1) All the voltages listed above are with respect to GND=0V ◦
- 2) Device is subject to be damaged permanently if stresses beyond those absolute maximum ratings listed above ◦
- 3) Note1: $T_A \leq 40^\circ\text{C}$ Without dewing

6. ELECTRICAL CHARACTERISTIC

A. Typical operating conditions

Items	Symbol	Min.	Typ.	Max.	Unit	Note
Power Voltage	VCI	2.7	3.3	3.6	V	
	VDD	1.65	3.3	3.6	V	
LCD driving current	I_{DD}	--	10	20	mA	
Output signal high voltage	VOH	0.8* VDD	-	VDD	V	
Output signal low voltage	VOL	GND	-	0.2*VDD	V	
Input signal high voltage	VIH	0.7* VDD	-	VDD	V	
Input signal low voltage	VIL	GND	-	0.3*VDD	V	

7. BACKLIGHT CHARACTERISTIC

ITEM	SYMBOL	CONDITION	Min	Typ	Max	Units
Backlight power supply	V_{LED}	$T_a = 25^{\circ}C$ $I = 20mA$	9	---	11.1	V
Backlight current	I_{LED}	$T_a = 25^{\circ}C$	---	20	---	mA

- Test Instrument: BM-7 (Distance =500mm; Field = 1°)
- Light Source: LED * 6 (White)
- Conditions: $V_F = 9\sim 11.1$ V; $I_F = 20mA$
- Measure Brightness: 1 ~ 9
- Uniformity = (Min. Brightness / Max. Brightness)*100%
- Uniformity ≥ 70 %

Note :

The maximum difference between LED voltages |(A1-K1)-(A2-K2)| of a single display shall be less than 1.0 V @ 20 mA .

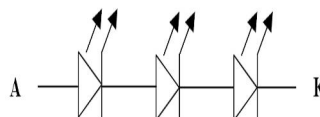
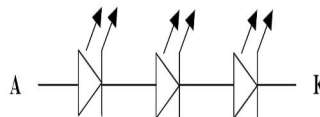
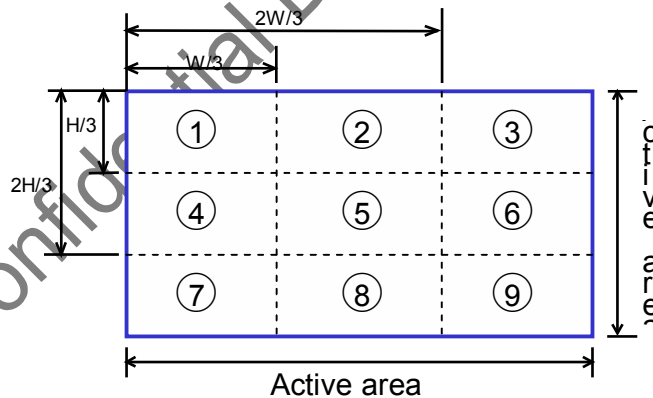

8. MODULE FUNCTION DESCRIPTION

8.1.Pin Description

Pin	Symbol	Description
1	LED A	LED Anode
2	LED A	LED Anode
3	LED K	LED Cathode
4	LED K	LED Cathode
5	GND	Ground
6	VCI	A supply voltage to the analog circuit ◦ Connect to an external power supply of 2.7V~3.6V ◦
7	NC	NC
8	VDD	Interface power supply = 1.65V~3.6V
9	GND	Ground
10	RESB	Chip reset Select Input PIN
11	CSB	A chip select signal ◦ CSB = L : the ILI9322 is selected and accessible CSB = H : the ILI9322 is not selected and not accessible Fix CSB to the IOVCC level when not in use ◦
12	SCK	SPI clock signal ◦ Fix SCK to GND level when not in use ◦
13	SDO	SPI interface output pin ◦ The data is outputted on the falling edge of the SCL signal ◦ Let SDO as floating when not used ◦
14	SDI	SPI interface input pin ◦ The data is latched on the rising edge of the SCL signal ◦ Fix SDI to GND level when not in use ◦
15	GND	Ground
16~23	B0~B7	Graphic display Blue data



KYOCERA Display Corporation

24~31	G0~G7	Graphic display Green data
32~39	R0~R7	Graphic display Red data

40	GND	Ground
41	DCLK	Clock signal The input data is latched on the rising edge of CLK ◦
42	HSYNC	Horizontal synchronizing input signal When the ITU-R BT656 input interface is selected, this pin is unused and short HSYNC pin to GND ◦
43	VSYNC	Vertical synchronizing input signal When the ITU-R BT656 input interface is selected, this pin is unused and short VSYNC pin to GND ◦
44	DEN	Input data enable signal VSYNC+HSYNC mode : This pin is shorted to GND normally and the back/front porch is determined by the control register ◦ VSYNC+HSYNC+DE mode : The valid data is determined by the VSYNC+HSYNC+DE pin ◦ DE mode : VSYNC and HSYNC are unused and shorted to GND ◦ The valid input data is determined by DE pin ◦ Fix DE to GND level when not in use ◦
45	GND	Ground

8.2. Timing Characteristics

8.2.1. 24-bit parallel interface

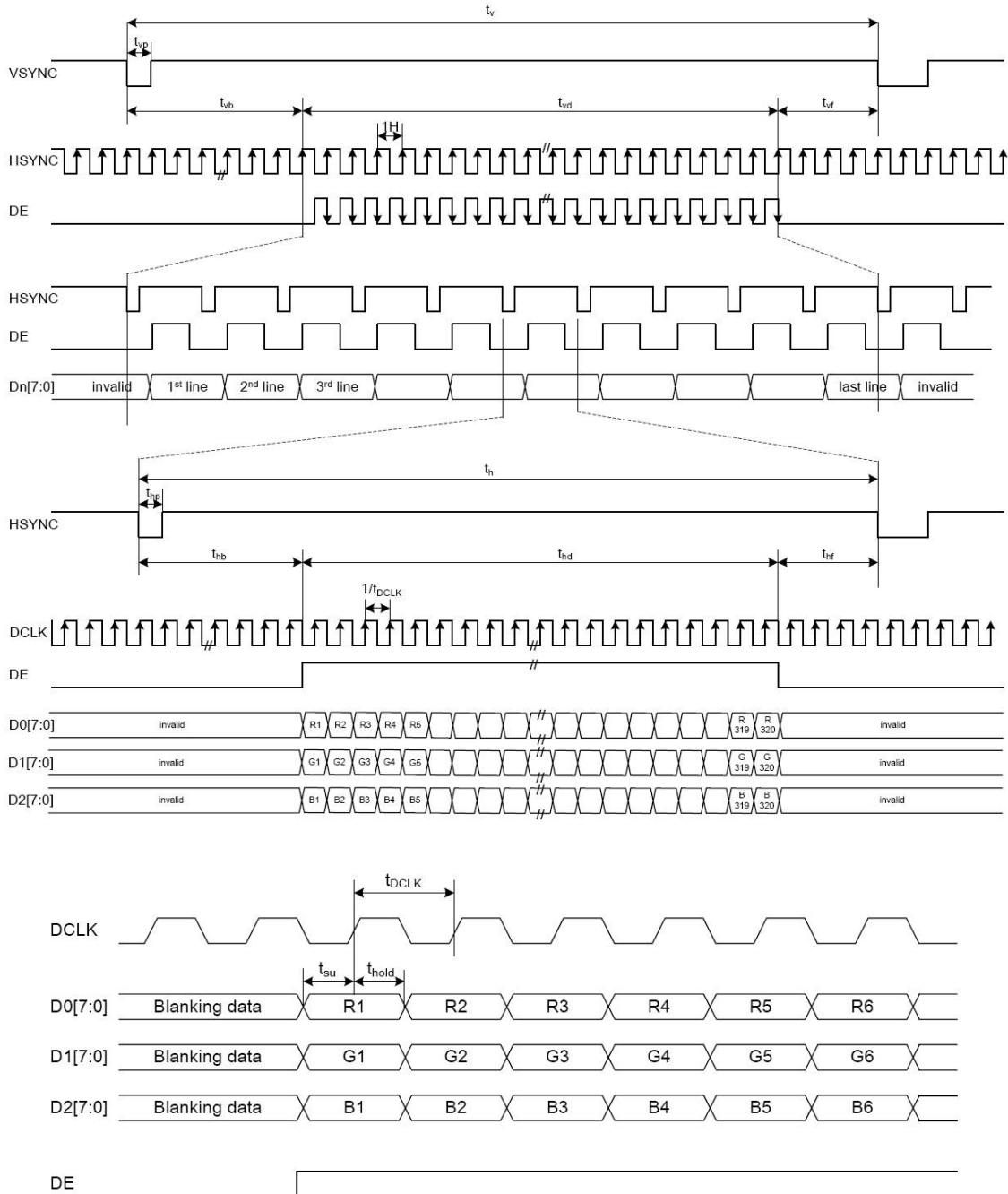

Parameter	Symbol	Min.	Typ.	Max.	Unit.	Note
DCLK Frequency	$1/t_{DCLK}$	-	6.4	11	MHZ	
Horizontal Period	t_h	-	408	-	t_{DCLK}	
Horizontal Display Period	t_{hd}	320	320	320	t_{DCLK}	
Horizontal Back Porch	t_{hb}	2	38	-	t_{DCLK}	
Horizontal Front Porch	t_{hf}	2	-	-	t_{DCLK}	
Horizontal Pulse Width	t_{hp}	1	1	-	t_{DCLK}	
Vertical Period	t_v	-	262	-	t_h	
Vertical Display Period	t_{vd}	240	240	240	t_h	
Vertical Back Porch	t_{vb}	2	18	-	t_h	
Vertical Front Porch	t_{vf}	2	4	-	t_h	
Vertical Pulse Width	t_{vp}	1	1	-	t_h	
Data setup time	t_{su}	12	-	-	ns	
Data hold time	t_{hold}	12	-	-	ns	

8.3. Serial Peripheral Interface (Spi)

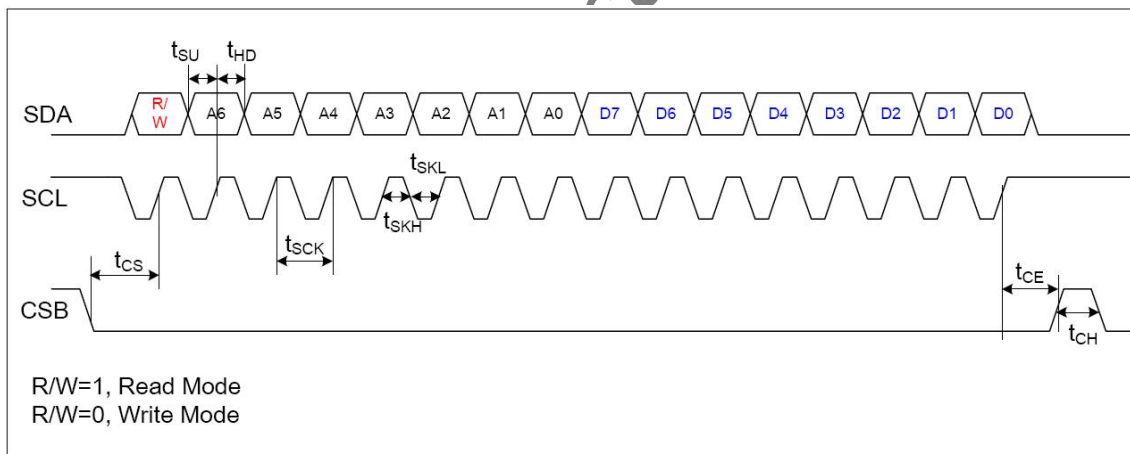

SPI Interface Input Signal Timing



KYOCERA Display Corporation

Items	Symbol	Min.	Typ.	Max.	Unit	Note
CSB to SCL Setup time	T_{CS}	50	-	-	ns	
CSB to SCL Hold time	T_{CE}	50	-	-	ns	
SCL Period	T_{SCK}	50	-	-	ns	
SCL High Period	T_{SKH}	25	-	-	ns	
SCL Low Period	T_{SKL}	25	-	-	ns	
Data Setup Time	T_{SU}	15	-	-	ns	
Data Hold Time	T_{HD}	15	-	-	ns	
CSB High Pulse Period	T_{CH}	50	-	-	ns	

8.4. Block diagram of LCM

KYD Confidential Document/Preliminary

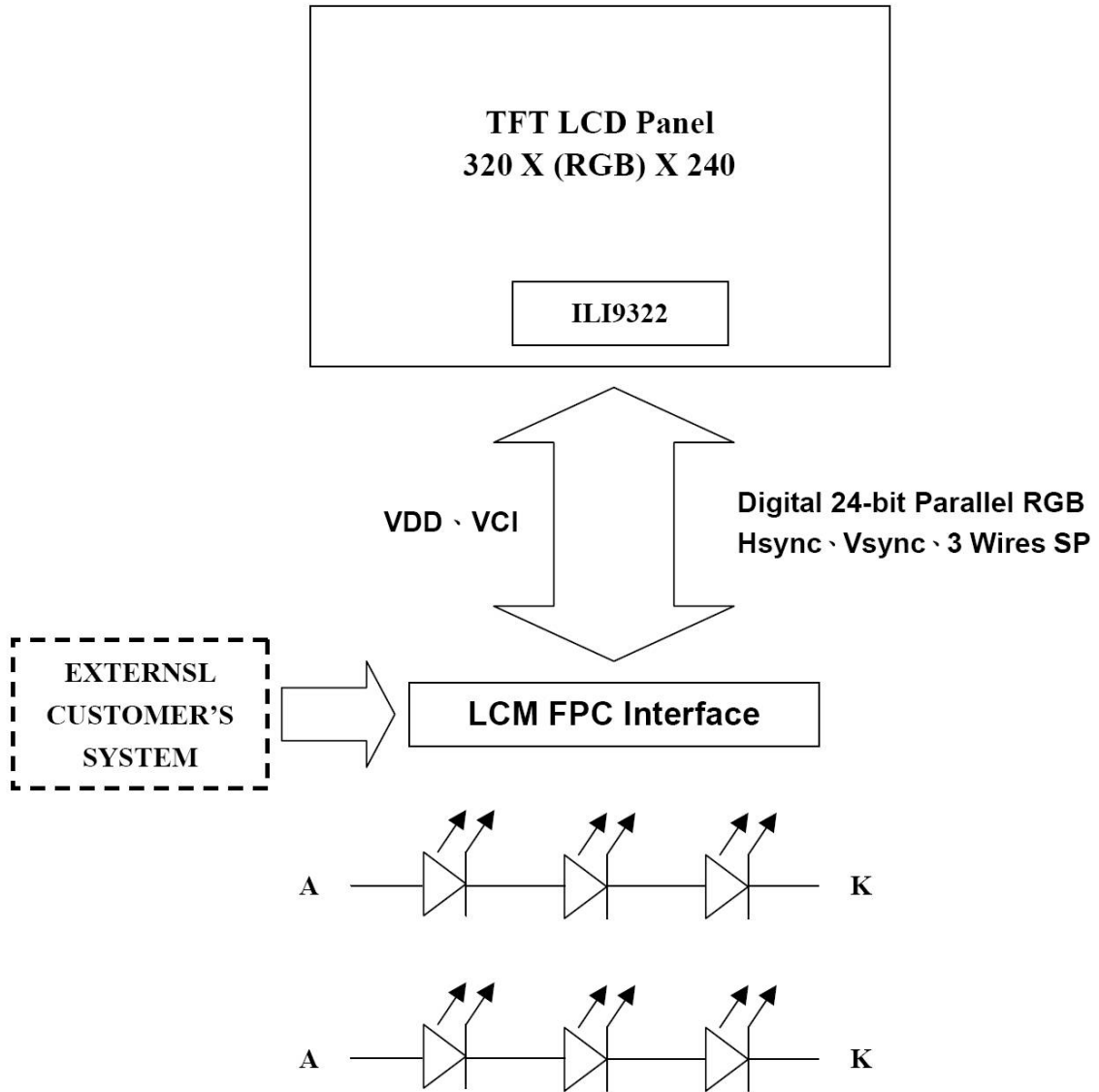

KYD Ç

9. ELECTRO-OPTICAL CHARACTERISTICS

Parameter		Symbol	Min.	Typ.	Max.	Units	Note
Luminance of white		Lwh	250	300	-	cd/m ²	3
Contrast Ratio		CR	-	300	-	-	5
CIE color Coordinates	White	x	0.27	0.32	0.37		BM5; 1° angle
		y	0.26	0.31	0.36		
	Red	x	0.59	0.64	0.69		
		y	0.30	0.35	0.40		
	Green	x	0.33	0.38	0.43		
		y	0.51	0.56	0.61		
	Blue	x	0.10	0.15	0.20		
		y	0.03	0.08	0.13		
Response Time		Tr+Tf	---	---	40	ms	4
Viewing Angle (with Polarizer)	Y axis down (12H)	ϕ_L	50	55	---	Degree	5
	Y axis up (6H)	ϕ_H	55	60	---		
	X axis right (9H)	θ_R	60	65	---		
	X axis left (3H)	θ_L	60	65	---		

Note:

1. Test equipment setup

After stabilizing and leaving the panel alone at a given temperature for 30 minutes, the measurement should be executed. Measurement should be executed in a stable, windless, and dark room. Optical specifications are measured by Topcon BM-5(fast) with a viewing angle of 1° at a distance of 50cm and normal direction.

2. Definition of response time: T_R and T_F

The figure below is the output signal of the photo detector.

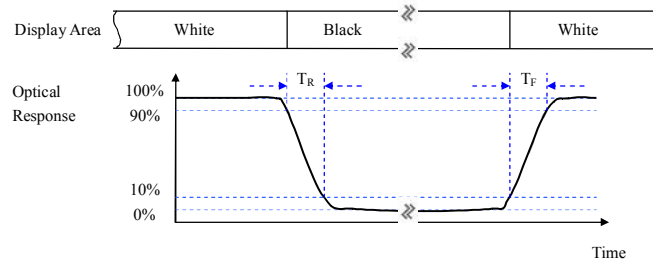

3. Definition of contrast ratio:

$$\text{Contrast ratio (CR)} = \frac{\text{Brightness measured when LCD is at "white state"}}{\text{Brightness measured when LCD is at "black state"}}$$

$$\text{White } V_i = V_{i50\%} \pm 1.5V$$

$$\text{Black } V_i = V_{i50\%} \mp 2.0V$$

" \pm " means that the analog input signal swings in phase with VCOM signal.

" \mp " means that the analog input signal swings out of phase with VCOM signal.

$V_{i50\%}$: The analog input voltage when transmission is 50%.

The 100% transmission is defined as the transmission of LCD panel when all the input terminals of module are electrically opened.

4. Measured at the center area of the panel when all the input terminals of LCD panel are electrically opened.

5. Definition of viewing angle:

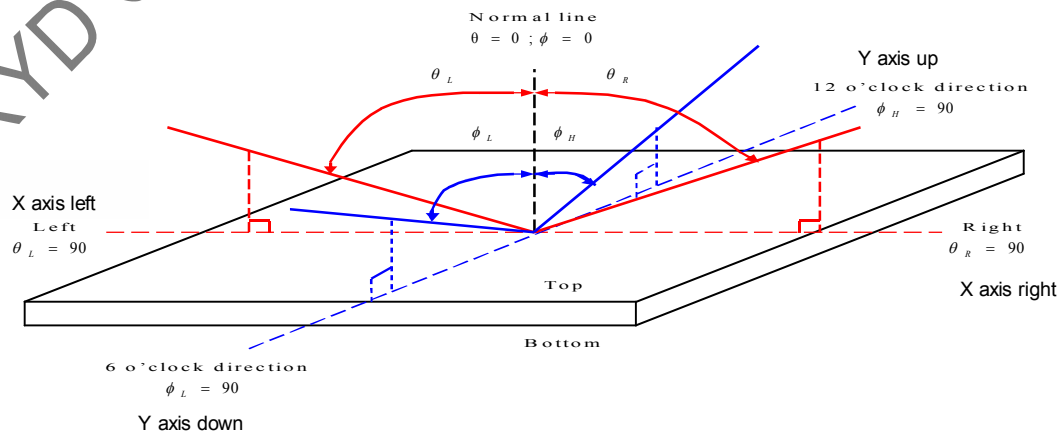

10.RELIABILITY

10.1.MTTF

The LCD module shall be designed to meet a minimum MTTF value of 50,000 hours with normal condition. (25°C in the room without sunlight; not include life time of backlight)

10.2.Tests

NO.	ITEM	CONDITION	CRITERION
1	High Temperature Operating	70°C 240 hrs	<ul style="list-style-type: none"> ◦ No defect of Operational functions in room temperature are allowable. ◦ Leakage current should be below double of initial value.
2	Low Temperature Operating	-20°C 240 hrs	
3	High Temperature Non-Operating	80°C 240 hrs	
4	Low Temperature Non-Operating	-30°C 240 hrs	
5	High Temperature/ Humidity Non-Operating	50°C ,90%RH 240 hrs	
6	Temperature Shock Non-Operating	-30°C ↔ 80°C (30min) (5min) (30min) 10 CYCLES	
7	Electro-static Discharge	HBM: ±2kv	

Note 1: Test after 24 hours in room temperature.

Note 2: The sampling above is individually for each reliability testing condition.

Note 3: The color fading of polarizing filter should not care.

Note 4: The entire reliability-testing chamber above is using D.I. water.

(Min value: 1.0 M ohm-cm)

Note 5: In case of malfunction defect caused by ESD damage, if it would be recovered to normal state after resetting, it would be judged as a good part.

10.3.Color performance

No.	ITEM	Criterion (initial)
1	Luminance	>50%
2	NTSC	>70%
3	Contrast Ratio	>50%

11.INSPECTION CRITERIA

11.1.Inspection Conditions

11.1.1.Environmental conditions

The environmental conditions for inspection shall be as follows

Room temperature: $23\pm 5^{\circ}\text{C}$

Humidity: $50\pm 20\%RH$

11.1.2.The external visual inspection

With a single 1000 ± 200 lux fluorescent lamp as the light source, the inspection was in the distance of 30cm or more from the LCD to the inspector's eyes.

11.2.Light Method

11.2.1.Environment lamp under 1000 ± 200 lux, Viewing direction for inspection

over 30cm

11.2.2.The distance from eye to defect around 300mm, the distance from ND

Filter to defect around 25~30mm

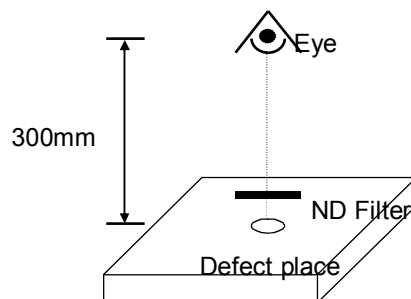

11.3. Classification Of Defects

11.3.1. Major defect

A major defect refers to a defect that may substantially degrade usability for product applications.

11.3.2. Minor defect

A minor defect refers to a defect which is not considered to be able substantially degrade the product application or a defect that deviates from existing standards almost unrelated to the effective use of the product or its operation.

Notes: If the LCD/LCM 's cosmetic and display performance do not specify in "inspection criterion", it should be based on these delivered samples.

11.4. Sampling & Acceptable Quality Level

Level II, MIL-STD-105E

	Major	Minor
Cosmetic	1.0 %	1.5 %
Electrical-display	0.4%	0.65 %

11.5. Definition Of Inspection Area

V.A: Viewing Area

A.A: Active Area

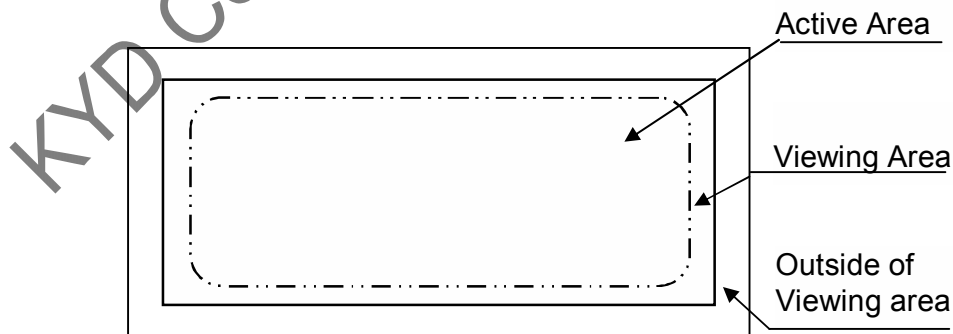



11.6. Items and Criteria

11.6.1. Visual inspection criterion in cosmetic

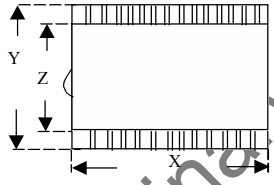
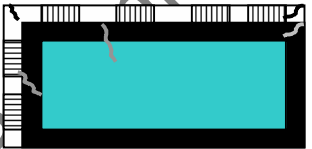
(1) Glass defect

No	Defect	Criteria	Remark
1	Dimension (Minor)	By engineering diagram	
2	Cracks (Major)	Extensive crack 【Reject】	

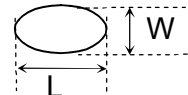
(2) LCM appearance defect with in A.A

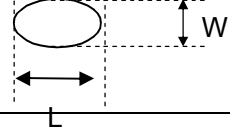
No	Defect	Criteria	Remark	
1	Round type (Minor)	Spec.	Permissible Qty	1. $\psi = (L+W)/2$, L: Length, W: Width 2. Disregard if out of A.A. 
		$\psi \leq 0.10\text{mm}$	Disregard	
		$0.10\text{mm} < \psi \leq 0.20\text{mm}$	3	
		$0.20\text{mm} < \psi$	0	
2	Line type (Minor)	Spec.	Permissible Qty	1. L: Length, W: Width 2. Disregard if out of A.A. 
		$W \leq 0.03\text{mm}$	Disregard	
		$L \leq 3.0\text{mm}$ and $0.03\text{mm} < W \leq 0.05\text{mm}$	2	
		$L \leq 3.0\text{mm}$ and $0.05\text{mm} < W \leq 0.10\text{mm}$	1	
		$W > 0.10\text{mm}$ or $L > 3.0\text{mm}$	0	
3	Polarizer dent (Minor)	Spec.	Permissible Qty	1. $\psi = (L+W)/2$, L: Length, W: Width 2. Disregard if out of A.A. 
		$\psi \leq 0.20\text{mm}$	Disregard	
		$0.20\text{mm} < \psi \leq 0.30\text{mm}$	2	
		$0.30\text{mm} < \psi \leq 0.50\text{mm}$	1	

	0.50mm< ψ	0	
--	----------------	---	--

(3) FPC

No	Defect	Criteria	Remark
1	Copper peeling (Minor)	Copper peeling 【Reject】	

(4) Silicon

No	Defect	Criteria	Remark
1	Amount of silicon (Minor)	ITO exposed 【Reject】	

11.6.2. Visual inspection criterion in electrical display

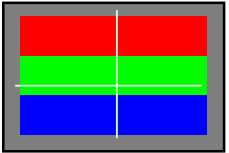
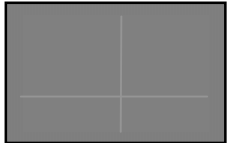
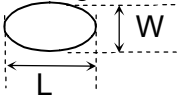
No	Defect	Criteria	Remark	
1	No display (Major)	Not allowed		
2	Missing line (Major)	Not allowed		
3	Darker or lighter line (Major)	Not allowed		
4	Weak line (Minor)	By limit sample		
5	Bright / Dark point (Minor)	Spec.	1:1sub-pixel: 1R or 1G or 1B 2:Point defect area \geq 1/2 sub pixel.	
		Bright point		Permissible Qty 1
		Dark point		2
6	Round type (Minor)	Spec.	1. $\psi = (L+W)/2$, L: Length, W: Width 2. Disregard if out of A.A. 	
		$\psi \leq 0.10\text{mm}$		Permissible Qty Disregard
		$0.10\text{mm} < \psi \leq 0.20\text{mm}$		3
		$0.20\text{mm} < \psi$		0

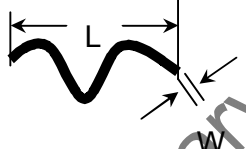
No	Defect	Criteria		Remark
7	Line type (Minor)	Spec.	Permissible Qty	1. L: Length, W: Width 2. Disregard if out of A.A. 
		$W \leq 0.03\text{mm}$	Disregard	
		$L \leq 3.0\text{mm}$ and $0.03\text{mm} < W \leq 0.05\text{mm}$	2	
		$L \leq 3.0\text{mm}$ and $0.05\text{mm} < W \leq 0.10\text{mm}$	1	
		$W > 0.10\text{mm}$ or $L > 3.0\text{mm}$	0	
8	Mura (Minor)	By 5% ND filter invisible		

11.6.3.Others

1. Issues that are not defined in this document shall be discussed and agreed with both parties. (Customer and supplier)
2. Unless otherwise agreed upon in writing, the criteria shall be applied to both parties. (Customer and supplier)
3. Polarizer, more than 0.5mm in size reduction rejected.

12.ILLUSTRATION OF LCD DATE CODE

(TBD)

13. RoHS COMPLIANT WARRANTY

RoHS Hazardous substances including:

- Cd < 100 ppm
- Pb < 1000 ppm
- Hg < 1000 ppm
- Cr +6 < 1000 ppm
- PBDE < 1000 ppm
- PBB < 1000 ppm

14. PRECAUTIONS FOR USE

14.1. Safety

- (1) Do not swallow any liquid crystal, even if there is no proof that liquid crystal is poisonous.
- (2) If the LCD panel breaks, be careful not to get liquid crystal to touch your skin.
- (3) If skin is exposed to liquid crystal, wash the area thoroughly with alcohol or soap.

14.2. Storage Conditions

- (1) Store the panel or module in a dark place where the temperature is $23\pm 5^{\circ}\text{C}$ and the humidity is below $50\pm 20\%\text{RH}$.
- (2) Store in anti-static electricity container.
- (3) Store in clean environment, free from dust, active gas, and solvent.
- (4) Do not place the module near organics solvents or corrosive gases.
- (5) Do not crush, shake, or jolt the module.
- (6) Do not exposed to direct sun light of fluorescent lamps.

14.3. Installing LCD Module

Attend to the following items when installing the LCM.

- (1) Cover the surface with a transparent protective plate or touch panel to protect the polarizer and LC cell.
- (2) When assembling the LCM into other equipment, the spacer to the bit between the

LCM and the fitting plate should have enough height to avoid causing stress to the module surface, refer to the individual specifications for measurements. The measurement tolerance should be ± 0.1 mm.

14.4. Precautions For Operation

- (1) Viewing angle varies with the change of liquid crystal driving voltage (V_0). Adjust V_0 to show the best contrast.
- (2) Driving the LCD in the voltage above the limit will shorten its lifetime.
- (3) Response time is greatly delayed at temperature below the operating temperature range. However, this does not mean the LCD will be out of the order. It will recover when it returns to the specified temperature range.
- (4) When turning the power on, input each signal after the positive/negative voltage becomes stable.
- (5) Do not apply water or any liquid on product which composed of T/P.

14.5. Handling Precautions

- (1) Avoid static electricity which can damage the CMOS LSI; please wear the wrist strap when handling.
- (2) The polarizing plate of the display is very fragile. so, please handle it very carefully.
- (3) Do not give external shock.
- (4) Do not apply excessive force on the surface; it may cause display abnormal .
- (5) Do not wipe the polarizing plate with a dry cloth, as it may easily scratch the surface of plate.
- (6) Do not use ketenes solvent & Aromatic solvent, use with a soft cloth soaked with a cleaning naphtha solvent.
- (7) Do not operate it above the absolute maximum rating.
- (8) Do not remove the panel or frame from the module.
- (9) Do not apply water or any liquid on product, which composed of T/P.

14.6. Warranty

- (1) The period is within 12 months since the date of shipping out under normal using and storage conditions.
- (3) The warranty will be avoided in case of defect induced by customer.

15. REVISION HISTORY

Version	Revise record	Date
A	New version	2012/03/07
B	Viewing Direction remark	2012/04/24

KYD Confidential Document/Preliminary