



FEATURES:

- Suitable for RoHS reflow profile
- High current rating and low DCR
- Special lead wire design to prevent open circuit failure
- Excellent terminal strength to mechanical stress

APPLICATIONS:

- OA equipments
- PC and notebook
- LCD TV set
- Power supply

ELECTRICAL SPECIFICATIONS:

Abrakon P/N:	ASPI-0705 Series
Operating Temperature:	-40°C to +85°C
Storage Temperature:	+5°C to +40°C

PART NUMBER	INDUCTANCE (uH)	Tolerance	DCR (Ω) max	IDC (A) max	Inductance Code
ASPI-0705-100	10	K	0.07	2.30	100
ASPI-0705-120	12	K	0.08	2.00	120
ASPI-0705-150	15	K	0.09	1.80	150
ASPI-0705-180	18	K	0.10	1.60	180
ASPI-0705-220	22	K	0.11	1.50	220
ASPI-0705-270	27	K	0.12	1.30	270
ASPI-0705-330	33	K	0.13	1.20	330
ASPI-0705-390	39	K	0.16	1.10	390
ASPI-0705-470	47	K	0.18	1.10	470
ASPI-0705-560	56	K	0.24	0.94	560
ASPI-0705-680	68	K	0.28	0.85	680
ASPI-0705-820	82	K	0.37	0.78	820
ASPI-0705-101	100	K	0.43	0.72	101
ASPI-0705-121	120	K	0.47	0.66	121
ASPI-0705-151	150	K	0.64	0.58	151
ASPI-0705-181	180	K	0.71	0.51	181
ASPI-0705-221	220	K	0.96	0.49	221
ASPI-0705-271	270	K	1.11	0.42	271
ASPI-0705-331	330	K	1.26	0.40	331
ASPI-0705-391	390	K	1.77	0.36	391
ASPI-0705-471	470	K	1.96	0.34	471

Test Conditions

Inductance: 2.52MHz for 10μH ~ 82μH; 1kHz for 100μH ~ 470μH

Isat: ΔL/L (initial) ≥ -10% or ΔT=40°C (Ta=20°C), whichever is lower.

OPTIONS AND PART IDENTIFICATION

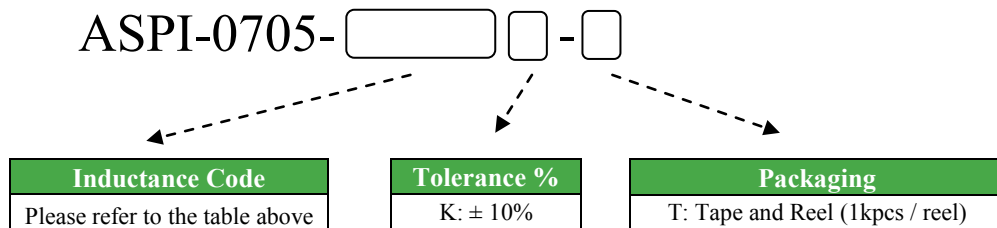



OUTLINE DRAWING:

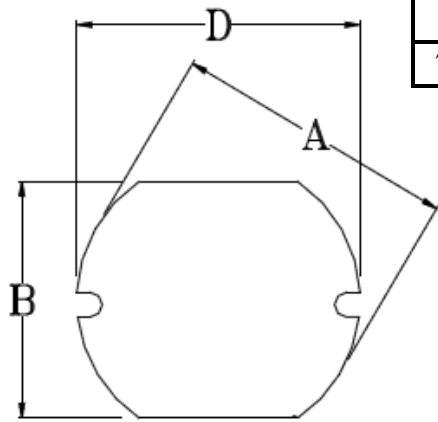

A	B	C	D	E	F	G
7.8±0.3	7.0±0.3	5.0±0.50	7.8±0.3	3.00	2.00	7.50

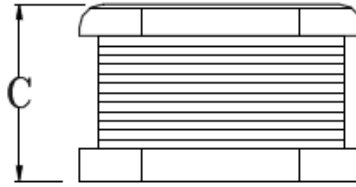

Recommended Land Pattern

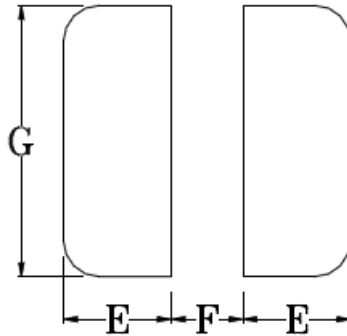
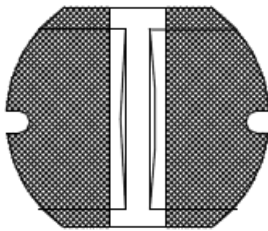

Dimension: mm

REFLOW PROFILE:

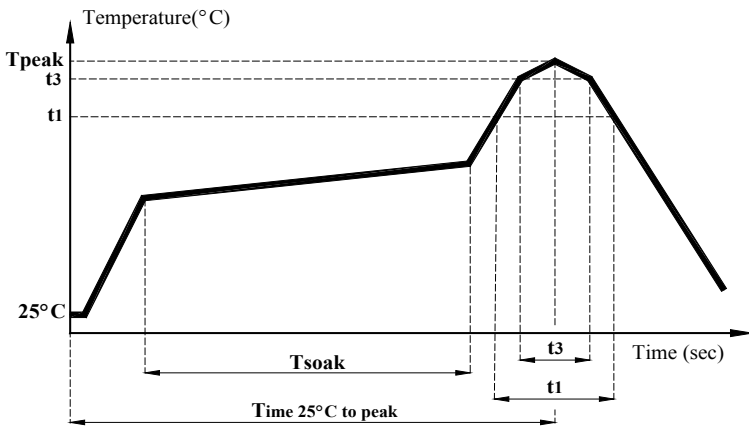

Item	mark	
Temperature rise gradient		3°C/sec (max)
Heating time	Tsoak	50s ~ 150s
Heating temperature		120°C~180°C
Time over 217°C	t1	70 sec
Time within 5°C of actual peak temperature	t3	10~30 sec
Peak temperature	Tpeak	250 (+0 / -5 °C)
Time 25°C to peak Temperature		6 minutes max.



TAPE & REEL:

T: 1,000pcs / reel

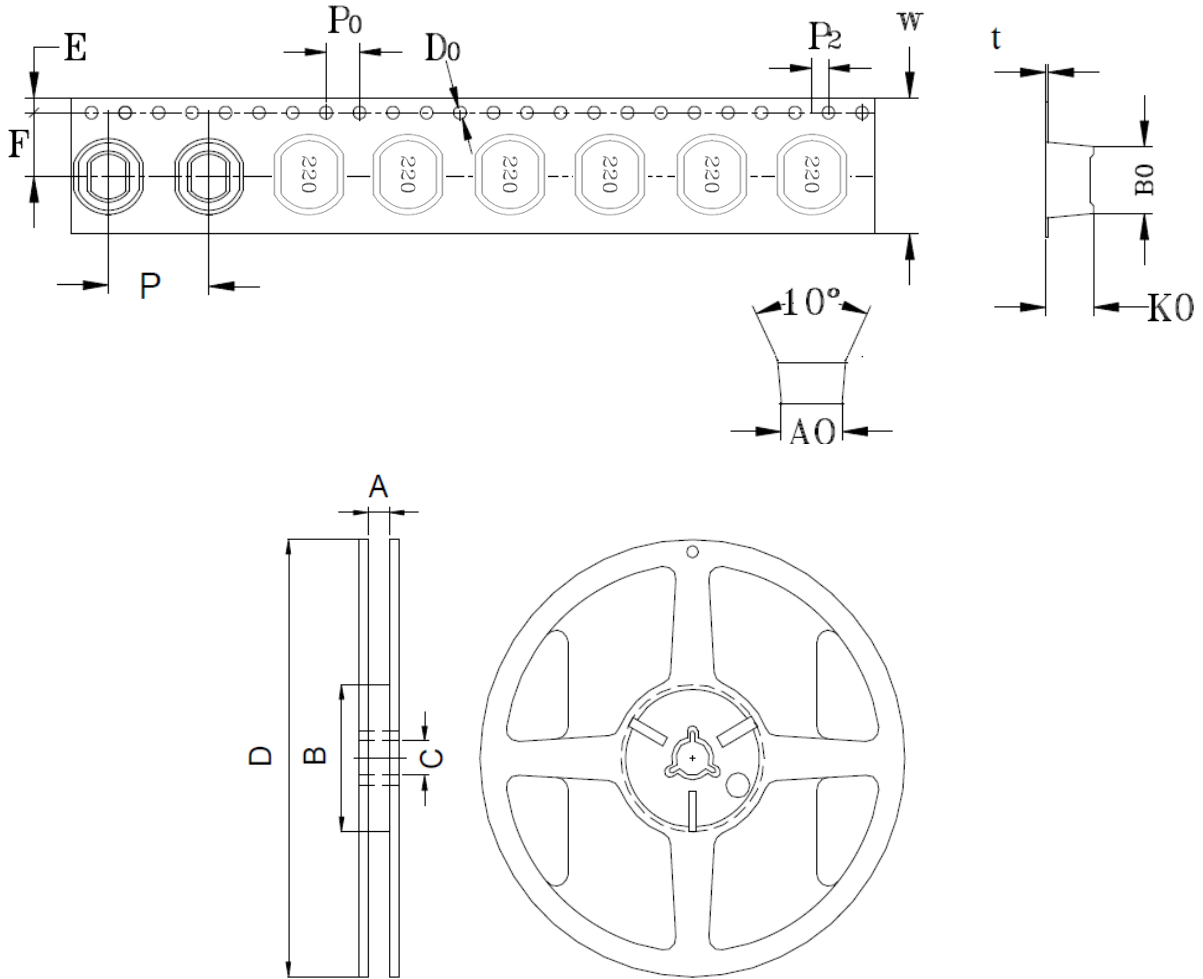

CARRIER TAPE / SIZE (mm)										REEL 13"×24mm			
A0	B0	K0	F	E	W	P	Po	P2	t	A	B	C	D
7.2 ± 0.1	8.1 ± 0.1	5.35 ± 0.1	7.5 ± 0.1	1.75 ± 0.1	16 ± 0.3	12 ± 0.1	4 ± 0.1	2 ± 0.1	0.4 ± 0.05	16.5 ± 0.2	100 ± 0.5	13.2 ± 0.3	330 ± 1.0

Dimension: mm

ATTENTION Abracon Corporation's products are COTS – Commercial-Off-The-Shelf products; suitable for Commercial, Industrial and, where designated, Automotive Applications. Abracon's products are not specifically designed for Military, Aviation, Aerospace, Life-dependant Medical applications or any application requiring high reliability where component failure could result in loss of life and/or property. For applications requiring high reliability and/or presenting an extreme operating environment, written consent and authorization from Abracon Corporation is required. Please contact Abracon Corporation for more information.