

## Peak Sensitivity Wavelength: 880nm

The MTD6100PT is a photo diode in a hermetically sealed pigtail package. It is well suited for high reliability and high sensitivity applications.

### FEATURES

- > Linearity of Ee vs IL
- > Low Dark Current / Metal Can Package
- > Narrow Angular Response
- > High Reliability in Demanding Environments

### APPLICATIONS

- > Optical Switches
- > Edge Sensing
- > Fiber Optical Communications
- > Smoke Detectors

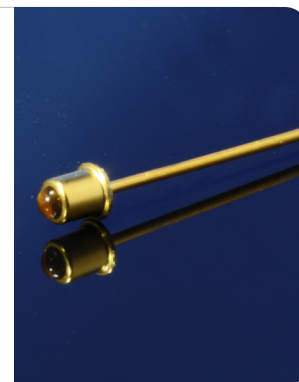

## Absolute Maximum Ratings (Ta=25°C)



ITEMS	SYMBOL	RATINGS	UNIT
Reverse Voltage	VR	30	V
Power Dissipation	PD	100	mW
Operating Temperature Range	Topt	-30 ~ +100	°C
Storage Temperature Range	Tstg	-40 ~ +125	°C
Junction Temperature	Tj	125	°C
Lead Soldering Temperature*1	Tls	260	°C

\*1: Time 5 Sec max, Position: Up to 3mm from the body.

## Electrical & Optical Characteristics (Ta = 25°C)

ITEMS	SYMBOL	CONDITIONS	MIN	TYP	MAX	UNIT
Open Circuit Voltage	Voc	Ee=5mW/cm <sup>2</sup> *1	0.35	--	--	V
Light Current	IL	*1, *2	--	10	--	μA
Dark Current	ID	VR=10V	--	--	10	nA
Curve Factor	CF	Ee=5mW/cm <sup>2</sup> *1	0.55	--	--	--
Spectral Sensitivity	λ	--	--	400~1100	--	nm
Peak Sensitivity Wavelength	λp	--	--	880	--	nm
Switching Time (Rise Time)	Tr	R=1000Ω, Vr=10V	--	6	--	nS
Switching Time (Fall Time)	Tf	R=1000Ω, Vr=10V	--	6	--	nS
Angular Response	Θ	--	--	±10	--	deg
Junction Capacitance	Cj	at 1MHz, V=5V	--	5	10	pF

\*1: Color Temperature=2870°K Standard Tungsten Lamp, \*2: VR=10V, Ee=5mW/cm<sup>2</sup>.

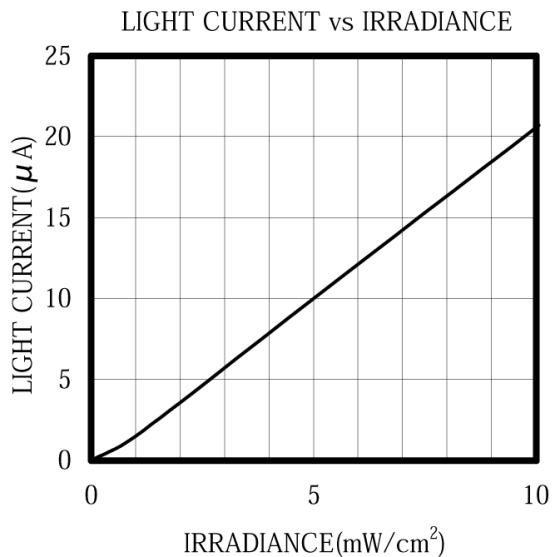
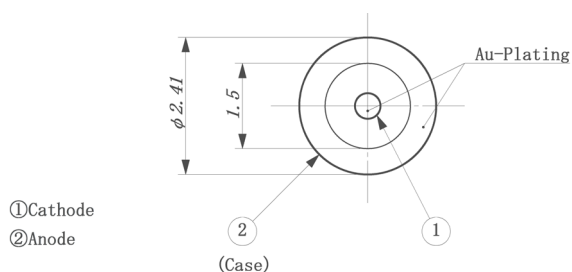
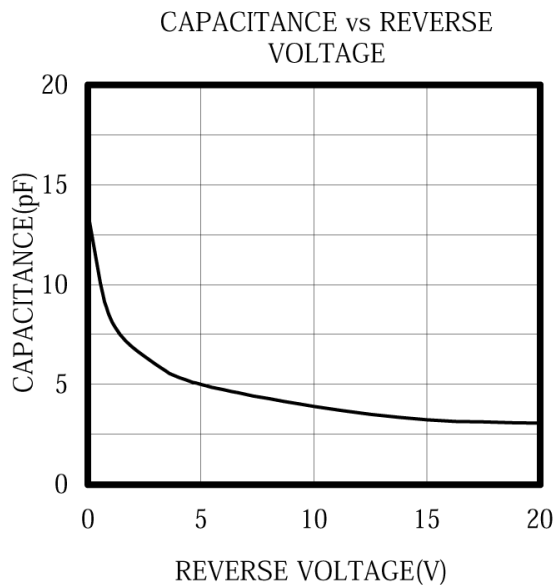
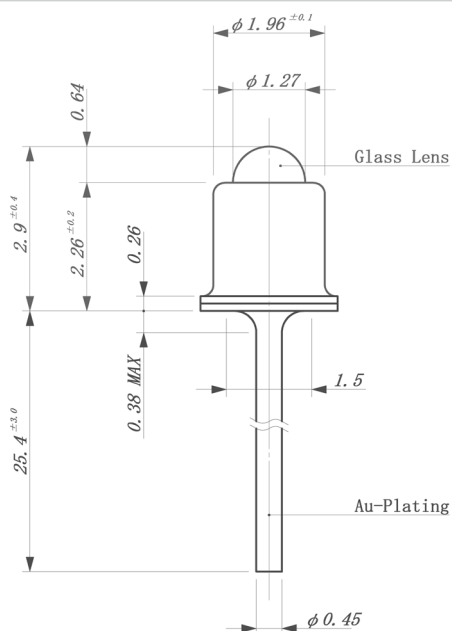

Unit: mm, Tolerance: ±0.2

ANGULAR DISPLACEMENT

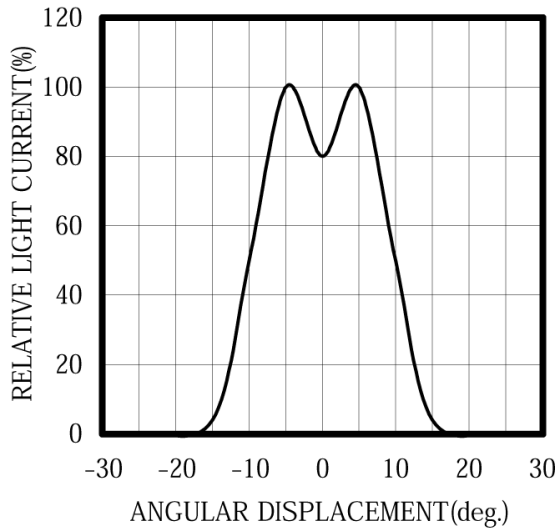

THERMAL DERATING CURVE

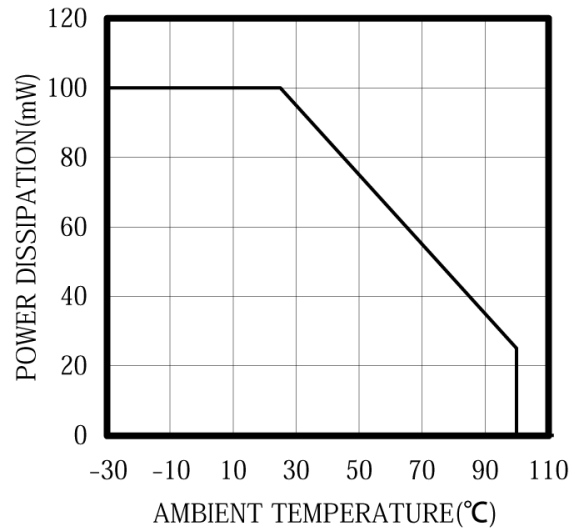

RESPONSIVITY

