

Surface Mount Termination 20 Watts, 50Ω

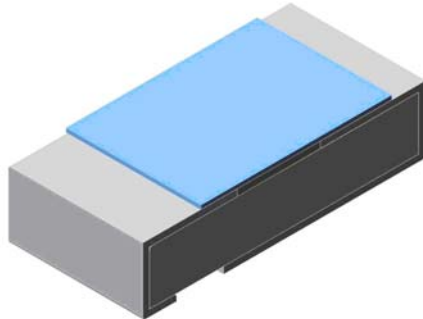

Description

The C20N50Z4 is high performance Aluminum Nitride (AlN) surface mount termination intended as a cost competitive alternative to Beryllium Oxide (BeO). The termination is well suited to all cellular frequency bands such as; AMPS, GSM, DCS, PCS, PHS and UMTS. The high power handling makes the part ideal for terminating high power 90 degree couplers and for use in microstrip circuits. The termination is also RoHS compliant!

General Specifications

Resistive Element	Thick film
Substrate	AlN Ceramic
Terminal Finish	Matte Tin over Nickel Barrier
Operating Temperature	-50 to +200°C (see de rating chart)

Tolerance is $\pm 0.010"$, unless otherwise specified. Designed to meet or exceed applicable portions of MIL-E-5400. **All dimensions in inches.**

Electrical Specifications

Resistance Value:	50 Ohms, $\pm 2\%$
Power:	20 Watts
Frequency Range:	DC – 2.3 GHz
Return Loss	>20 dB to 2.3 GHz

Specification based on unit properly installed using suggested mounting instructions and a 50 ohm nominal impedance. **Specifications subject to change.**

Features:

- RoHS Compliant
- 20 Watts
- DC - 2.3 GHz
- AlN Ceramic
- Non-Nichrome Resistive Element
- Low VSWR
- 100% Tested
- Small Size

Outline Drawing

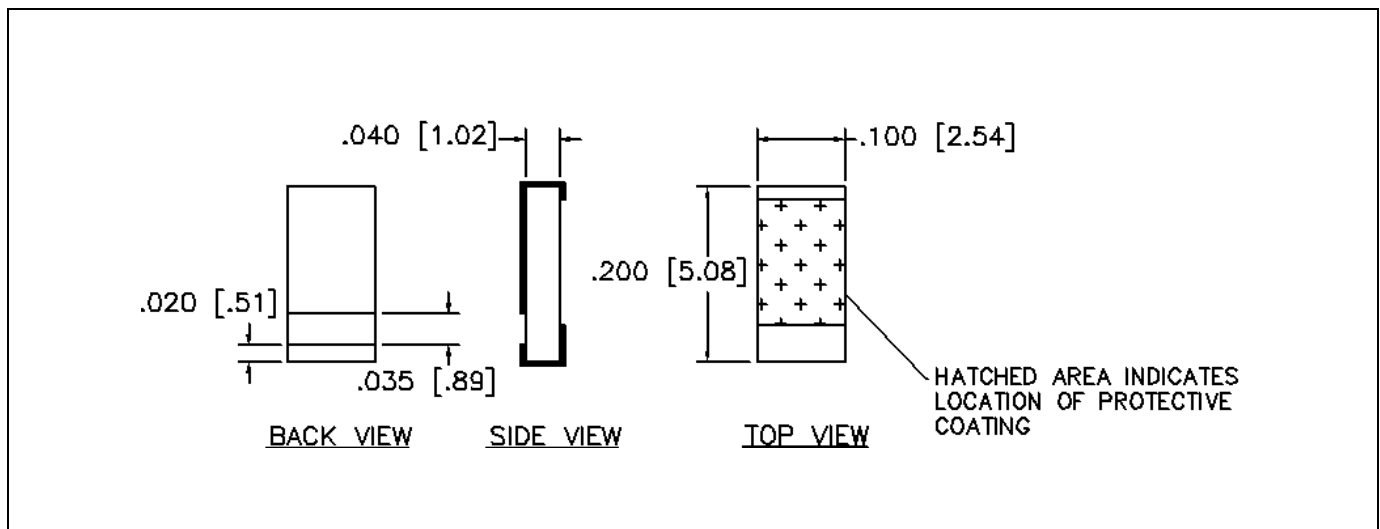

1 of 2



Typical Performance:

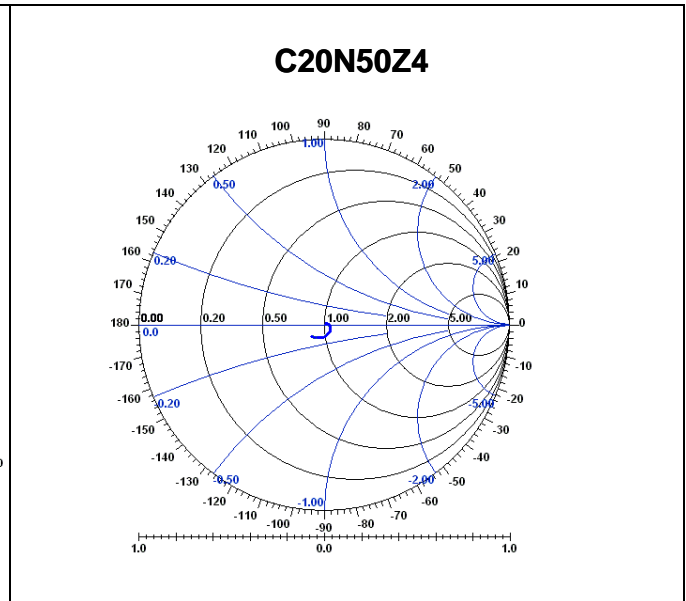
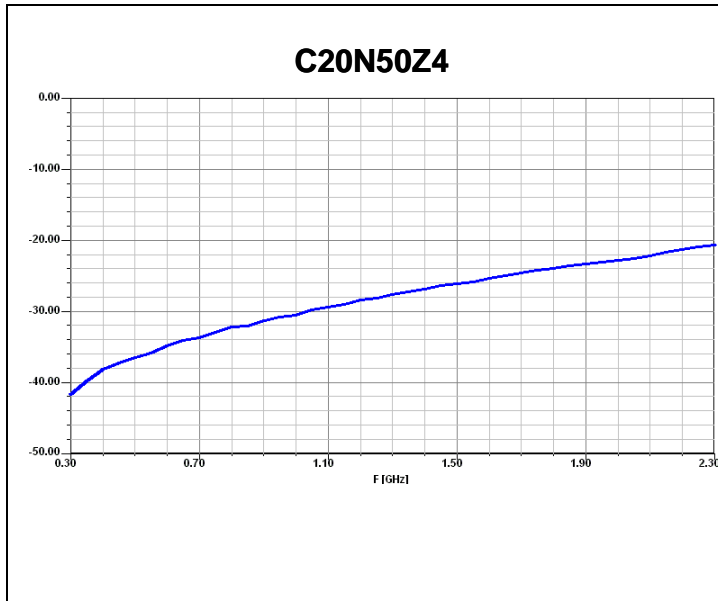

Power De-rating:

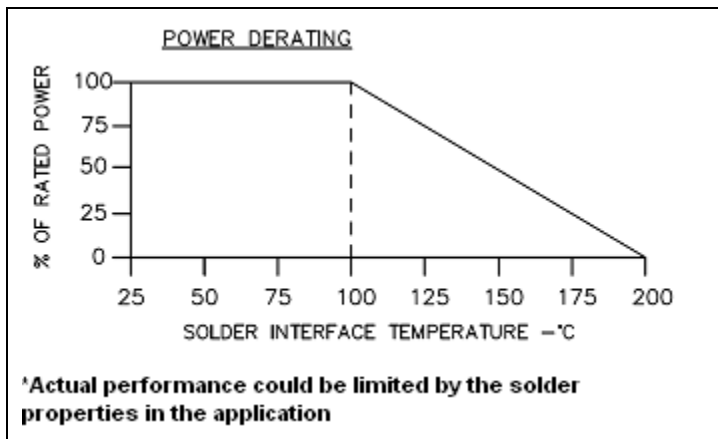

Tape & Reel [Available]:

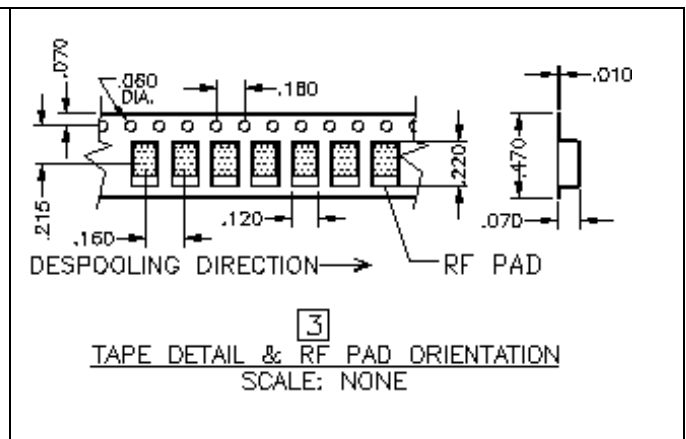

Mounting Footprint and Procedure:

