

Distributor Stocking Part

Fox Part Number: FQ3225BR-16.000



RESIN-SEALED, SMD, CRYSTAL
MODEL: FQ3225B Series

RoHS / REACH Compliant / Pb Free

A. Specifications

Parameters	
Frequency	16.000 MHz
Resonance Mode	Fundamental
Frequency Tolerance @ 25°C	±50 PPM Max
Frequency Stability, ref @ 25°C Over Operating Temp. Range	±50 PPM Max
Temperature Range Operating (T _{OPR}) Storage (T _{STG})	-40°C ~ +85°C -55°C ~ +125°C
Equivalent Series Resistance (ESR)	100 Ohms Max
Shunt Capacitance (C _O)	7 pF Max
Load Capacitance (C _L)	20 pF
Drive Level	0.1 mW Max
Aging per year	±5 PPM Max
Maximum Soldering Temp / Time	260°C / 10 Seconds
Moisture Sensitivity Level (MSL)	1
Termination Finish:	Au

B. Mechanical / Dimensions (millimeters):

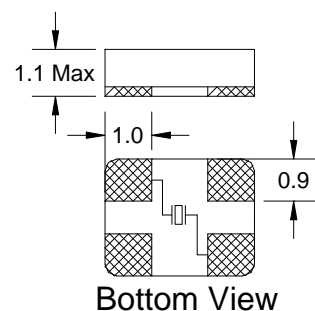
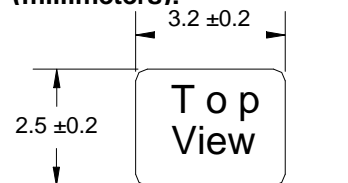

Recommended Solder pad layout

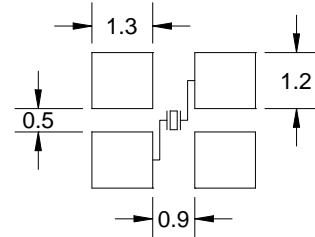

FQ Series Marking Identification

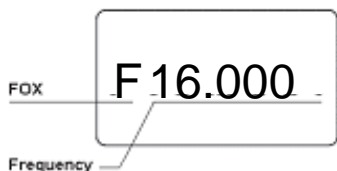

C. Tape & Reel Specifications (in millimeters)

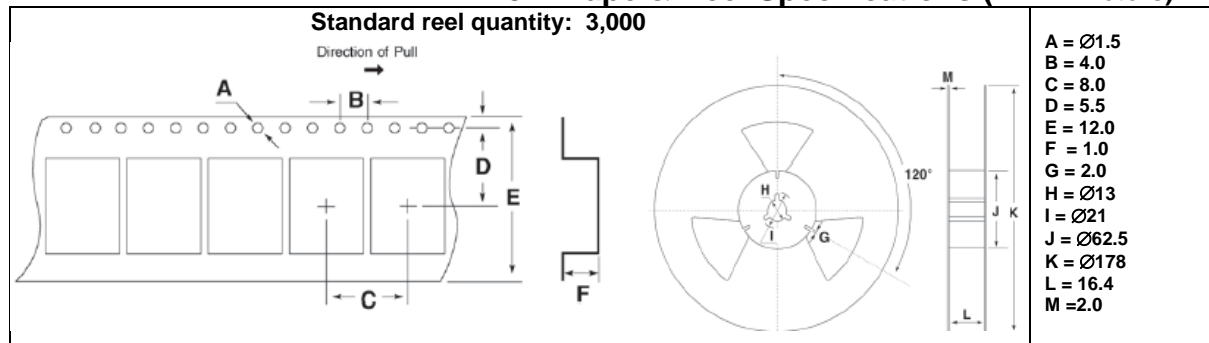

NOTE: The above specifications, having been carefully prepared and checked, is believed to be accurate at the time of publication; however, no responsibility is assumed by Fox Electronics for inaccuracies.

Reference / Comments	Title / Description: <i>Product Specifications</i>		
Initial release	Drawing Number: DOC101003	Rev: 1	Size: A
	Part Number: FQ3225BR-16.000		Cage: 61429
	Draftsperson: AR	Approved: GB	Date: 05-20-2014