

Part Number: APBA3010SYKCGKC-GX

Super Bright Yellow
Green

Features

- 3.0mmx1.0mm right angle SMT LED, 2.0mm thickness.
- Low power consumption.
- Wide viewing angle.
- Ideal for backlight and indicator.
- Various colors and lens types available.
- Package : 2000pcs / reel.
- Moisture sensitivity level : level 3.
- Tinned pads for improved solderability
- RoHS compliant.

Description

The Super Bright Yellow device is made with AlGaInP (on GaAs substrate) light emitting diode chip.
The Green source color devices are made with AlGaInP on GaAs substrate Light Emitting Diode.

Package Dimensions

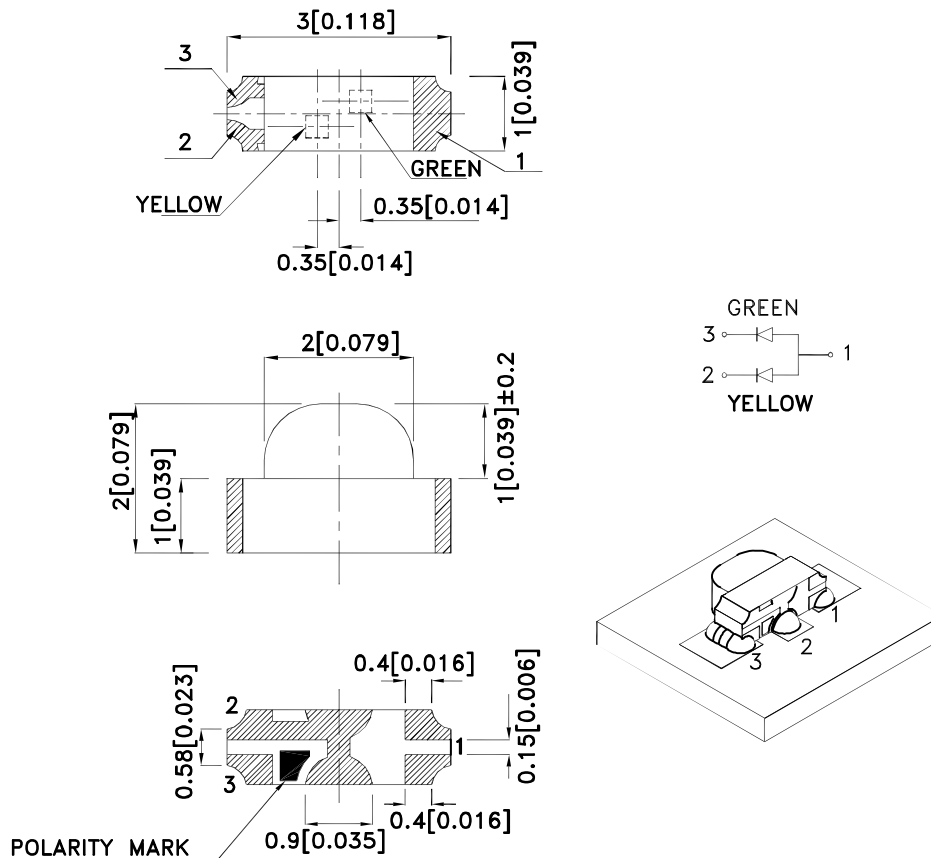

Notes:

1. All dimensions are in millimeters (inches).
2. Tolerance is $\pm 0.15(0.006)$ unless otherwise noted.
3. The specifications, characteristics and technical data described in the datasheet are subject to change without prior notice.
4. The device has a single mounting surface. The device must be mounted according to the specifications.



Selection Guide

Part No.	Dice	Lens Type	Iv (mcd) [2] @ 20mA		Viewing Angle [1]
			Min.	Typ.	2θ1/2
APBA3010SYKCGKC-GX	Super Bright Yellow (AlGaInP)	Water Clear	80	120	140°
	Green (AlGaInP)		40	70	

Notes:

1. θ1/2 is the angle from optical centerline where the luminous intensity is 1/2 of the optical peak value.
 2. Luminous intensity/ luminous Flux: +/-15%.
- *Luminous intensity value is traceable to the CIE127-2007 compliant national standards.

Electrical / Optical Characteristics at TA=25°C

Symbol	Parameter	Device	Typ.	Max.	Units	Test Conditions
λpeak	Peak Wavelength	Super Bright Yellow Green	590 574		nm	IF=20mA
λD [1]	Dominant Wavelength	Super Bright Yellow Green	590 570		nm	IF=20mA
Δλ1/2	Spectral Line Half-width	Super Bright Yellow Green	20 20		nm	IF=20mA
C	Capacitance	Super Bright Yellow Green	20 15		pF	VF=0V;f=1MHz
VF [2]	Forward Voltage	Super Bright Yellow Green	2 2.1	2.5 2.5	V	IF=20mA
IR	Reverse Current	Super Bright Yellow Green		10 10	uA	VR = 5V

Notes:

- 1.Wavelength: +/-1nm.
 - 2.Forward Voltage: +/-0.1V.
- *Wavelength value is traceable to the CIE127-2007 compliant national standards.

Absolute Maximum Ratings at TA=25°C

Parameter	Super Bright Yellow	Green	Units
Power dissipation	75	75	mW
DC Forward Current	30	30	mA
Peak Forward Current [1]	175	150	mA
Reverse Voltage	5		V
Operating Temperature	-40°C To +85°C		
Storage Temperature	-40°C To +85°C		

Note:

1. 1/10 Duty Cycle, 0.1ms Pulse Width.

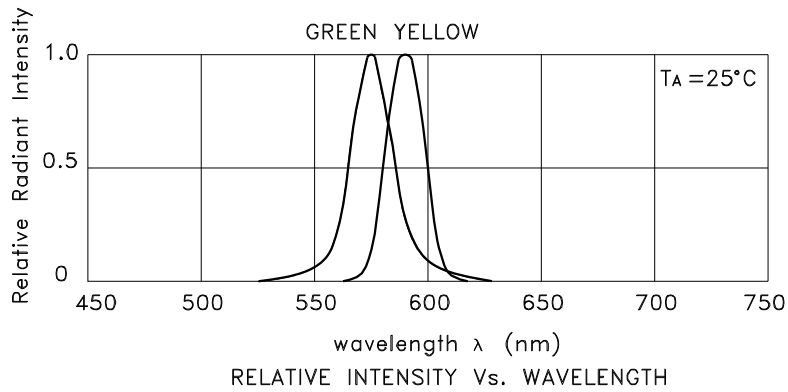

APBA3010SYKCGKC-GX Super Bright Yellow

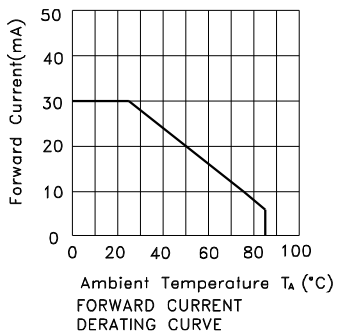

Kingbright

Green

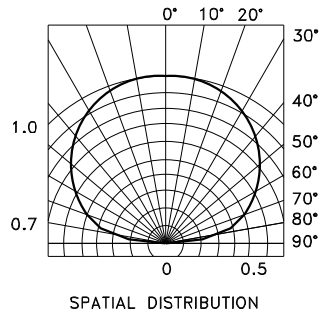
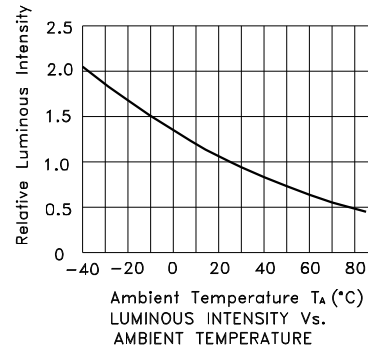

PACKING & LABEL SPECIFICATIONS

APBA3010SYKCGKC-GX

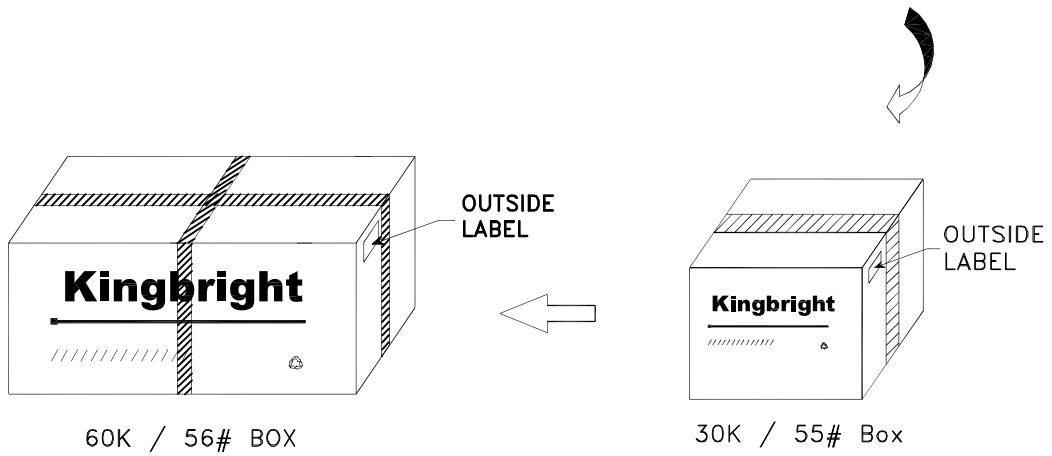
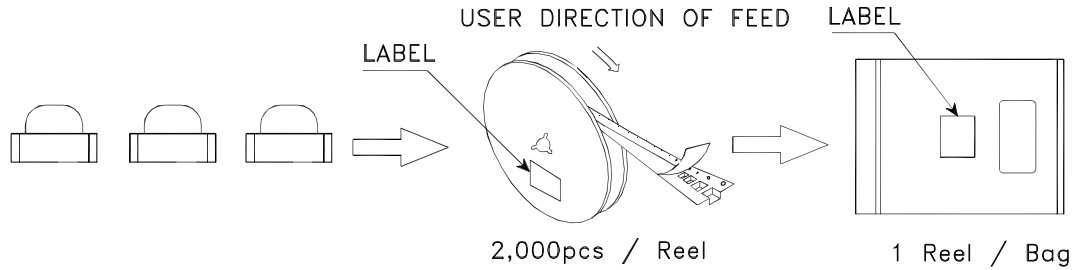

<h2 style="margin: 0;">Kingbright</h2>	
P/NO: APBA3010XXX	
QTY: 2,000 pcs	Q.C. Q C xx xx xxxx PASSED
S/N: XXXX	
CODE: XXX	
LOT NO:	
 XXXXXXXXXXXXXXXXXXXXXXXXXXXX	
RoHS Compliant	