

THESE DRAWINGS ARE THE PROPERTY OF QUALTEK ELECTRONICS AND NOT TO BE REPRODUCED FOR OR COMMUNICATED TO A THIRD PARTY WITHOUT THE EXPRESS WRITTEN PERMISSION OF AN OFFICER OF QUALTEK ELECTRONICS.

REVISION			
REV.	DESCRIPTION	DATE	APPROVED
B	Updated Approvals	10-15-08	LY

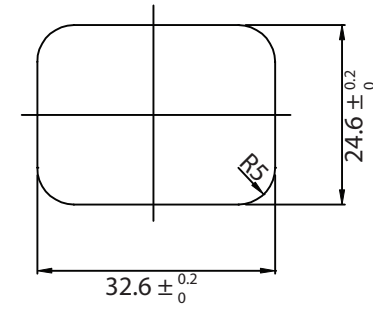

PANEL CUTOUT

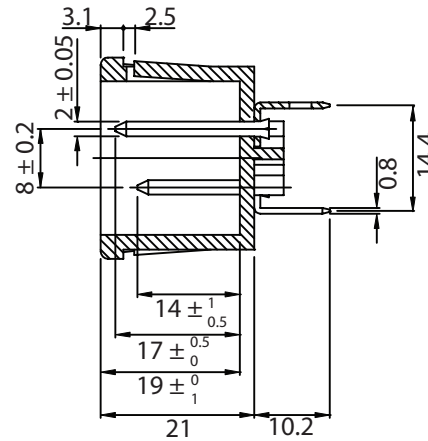
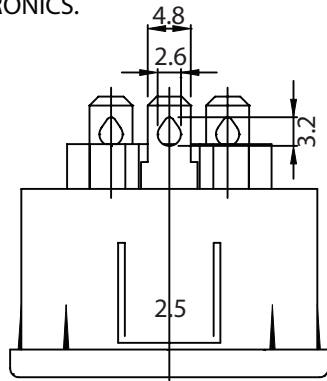
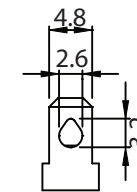
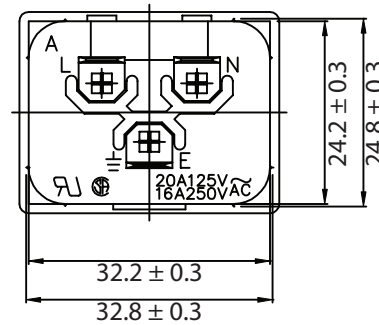
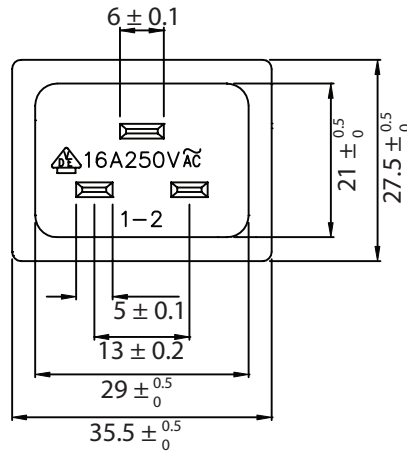

NOTES:

RATING:

UL, CSA: 20A 125V AC/16A 250V AC  
 VDE, CCC: 16A 250V AC  
 APPROVALS: UL, CSA, VDE, CCC  
 PANEL THICKNESS: 2.5mm  
 IEC 60320 C20  
 RoHS COMPLIANT

**CONTROLLED**

Dim range (mm)	Tolerance +/- (mm)	Qualtek Electronics Corp. PPC DIVISION		
		Part Number:	745W-25/15	
0-1	0.15	Description: AC RECEPTACLE		
1-6	0.20			
6-18	0.30			
18-50	0.50			
50-120	0.70	Drawn / Date	UNIT: mm	REV. B
120-250	0.90	Checked / Date		Approved / Date
250-500	1.20	R.Nuti 10-02-08	10-02-08	LY/ 10-02-08