

REV.	REVISION CHANGES
A1	ADDED NEW FORMAT
A2	ADDED 50uIN GOLD PART NUMBER

PART NO. SS-718802S-A-NF (30uIN GOLD)
 PART NO. SS-718802S-A-NF-50 (50uIN GOLD)

CAT 5 JACK

EMI-RFI ONE PIECE SHIELDED, ESD GROUNDED
 2 PORT PCB HARMONICA JACK PAC
 "-NF" NON-FLANGE

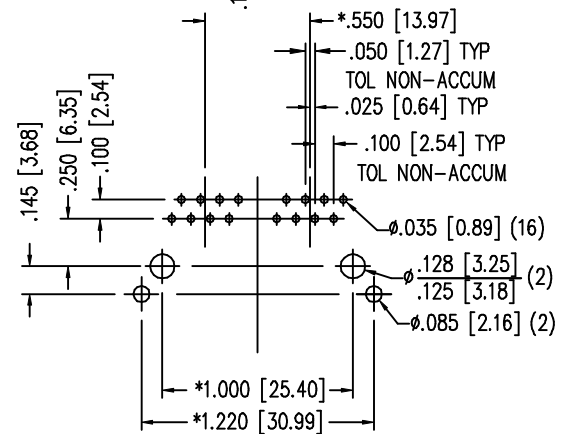
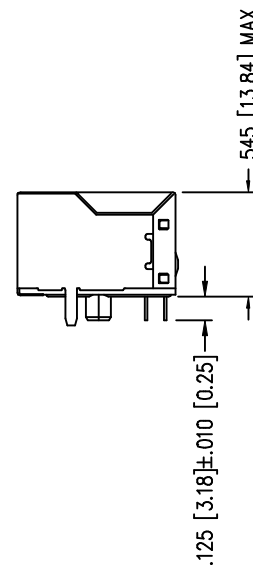
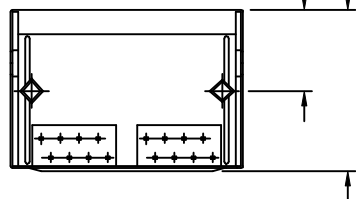
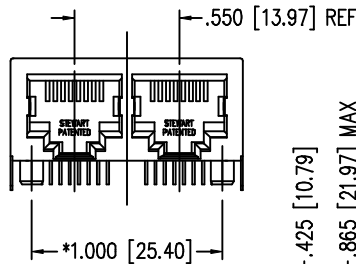
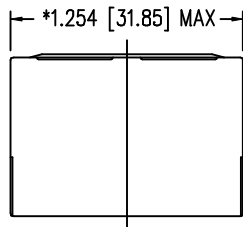
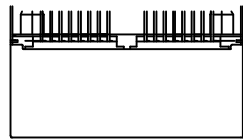

P.C.B. RECOMMENDED HOLE LAYOUT
 SEEN FROM COMPONENT SIDE
 TOLERANCE ±.003 [0.08] UNLESS OTHERWISE SPECIFIED

NOTES:

- MEETS CATEGORY 5 PERFORMANCE SPECIFICATION AS TESTED PER TIA/EIA 568A.
- TOLERANCES COMPLY WITH F.C.C. DIMENSION REQUIREMENTS ALL OTHERS ±.005 [0.13] UNLESS OTHERWISE SPECIFIED.
- DIMENSIONS SHOWN WITH "*" TO BE CENTRAL ABOUT CENTER LINE

AVAILABLE WITH:

- LOADED 1 - 8 CONTACTS

CT710044

SHT. 1 OF 1

THIRD ANGLE PROJECTION

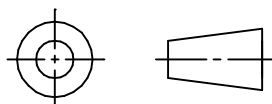

THIS DRAWING AND THE SUBJECT MATTER SHOWN THEREON ARE CONFIDENTIAL AND THE PROPRIETARY PROPERTY OF STEWART CONNECTOR ("SCS") AND SHALL NOT BE REPRODUCED, COPIED OR USED IN ANY MANNER WITHOUT PRIOR WRITTEN CONSENT OF "SCS". THE SUBJECT MATTER MAY BE PATENTED OR A PATENT MAY BE PENDING. © SCS