



PART No. 1418N4S16K16

for more information visit  
[www.hamfmg.com](http://www.hamfmg.com)

Data subject to change without notice

Isometric drawing Not to Scale

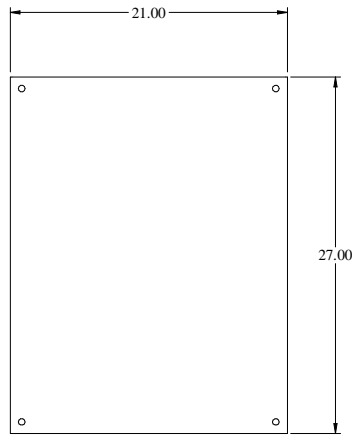

INNER PANEL



BACK VIEW

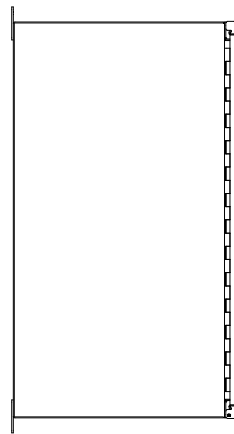

SIDE VIEW

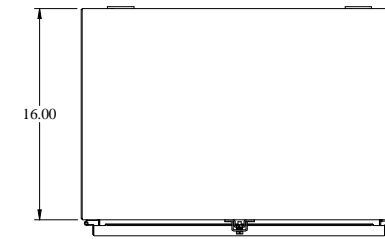

TOP VIEW

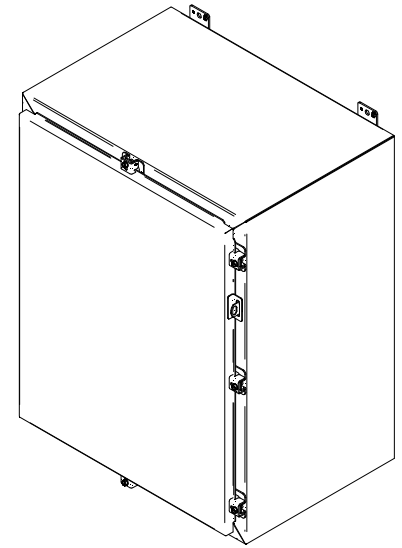

ISOMETRIC VIEW

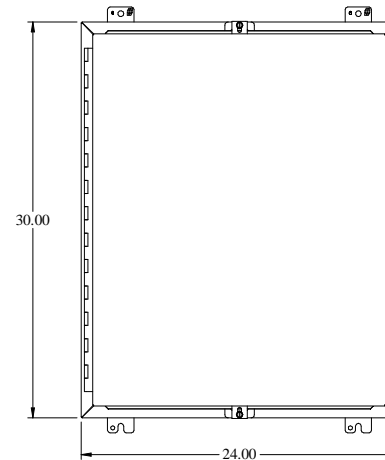

FRONT VIEW

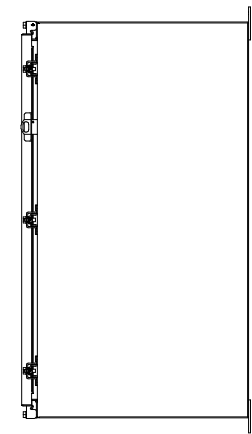

SIDE VIEW

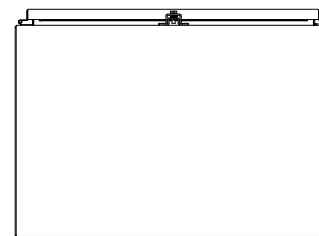

BOTTOM VIEW