

Data Sheet

Description

The MSA-9970 is a high performance silicon bipolar Monolithic Microwave Integrated Circuit (MMIC) housed in a hermetic high reliability package. This MMIC is designed with high open loop gain and is intended to be used with external resistive and reactive feedback elements to create a variety of special purpose gain blocks.

Applications include very broadband, minimum ripple amplifiers with extended low frequency performance possible through the use of a high valued external feedback blocking capacitor; extremely well matched (-20 dB return loss) amplifiers; and negative gain slope amplifiers for flattening MMIC cascades.

The MSA-series is fabricated using Avago's 10 GHz f_T , 25 GHz f_{MAX} , silicon bipolar MMIC process which uses nitride self-alignment, ion implantation, and gold metallization to achieve excellent performance, uniformity and reliability. The use of an external bias resistor for temperature and current stability also allows bias flexibility.

70 mil Package

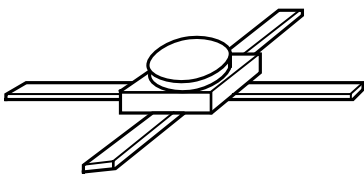

Features

- Open Loop Feedback Amplifier
- Performance Flexibility with User Selected External Feedback for:
 - Broadband Minimum Ripple Amplifiers
 - Low Return Loss Amplifiers
 - Negative Gain Slope Amplifiers
- Usable Gain to 6.0 GHz
- 16.0 dB Typical Open Loop Gain at 1.0 GHz
- 14.5 dBm Typical P_{1dB} at 1.0 GHz
- Hermetic Gold-ceramic Microstrip Package

Typical Biasing Configuration

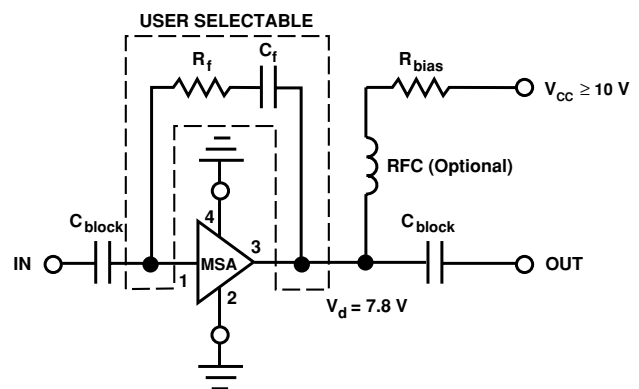

MSA-9970 Absolute Maximum Ratings

Parameter	Absolute Maximum ^[1]
Device Current	80 mA
Power Dissipation ^[2,3]	750 mW
RF Input Power	+13 dBm
Junction Temperature	200°C
Storage Temperature	-65°C to 200°C

Thermal Resistance^[2,4]:

$$\theta_{jc} = 150^{\circ}\text{C/W}$$

Notes:

1. Permanent damage may occur if any of these limits are exceeded.
2. $T_{\text{CASE}} = 25^{\circ}\text{C}$.
3. Derate at 6.7 mW/°C for $T_{\text{C}} > 88^{\circ}\text{C}$.
4. The small spot size of this technique results in a higher, though more accurate determination of θ_{jc} than do alternate methods.

Electrical Specifications^[1], $T_{\text{A}} = 25^{\circ}\text{C}$

Symbol	Parameters and Test Conditions: $I_{\text{d}} = 35 \text{ mA}$, $Z_0 = 50 \Omega$	Units	Min.	Typ.	Max.	
G_{p}	Power Gain ^[2] ($ S_{21} ^2$)	f = 0.1 GHz		17.5		
			f = 1.0 GHz	14.5	16.0	17.5
			f = 4.0 GHz	8.0	9.0	10.0
$P_{1 \text{ dB}}$	Output Power at 1 dB Gain Compression ^[2]	f = 1.0 GHz		14.5		
IP_3	Third Order Intercept Point ^[2]	f = 1.0 GHz		25.0		
V_{d}	Device Voltage	V	7.0	7.8	8.6	
dV/dT	Device Voltage Temperature Coefficient	mV/°C		-16.0		

Notes:

1. The recommended operating current range for this device is 25 to 45 mA. Typical performance as a function of current is on the following page.
2. Open loop value. Adding external feedback will alter device performance.

MSA-9970 Typical Scattering Parameters ($Z_0 = 50 \Omega$, $T_A = 25^\circ\text{C}$, $I_d = 35 \text{ mA}$)

Freq. GHz	S_{11}		dB	S_{21}		dB	S_{12}		S_{22}		k
	Mag	Ang		Mag	Ang		Mag	Ang	Mag	Ang	
0.02	.89	-1	17.5	7.51	179	-37.2	.014	4	.93	-1	1.01
0.05	.90	-3	17.5	7.47	177	-35.6	.017	34	.92	-3	.83
0.1	.90	-6	17.4	7.45	174	-33.2	.022	43	.93	-6	.70
0.2	.89	-12	17.4	7.43	168	-29.6	.033	61	.93	-13	.39
0.4	.87	-24	17.2	7.27	156	-24.4	.061	63	.91	-27	.24
0.6	.85	-36	17.0	7.06	145	-20.8	.091	58	.90	-40	.21
0.8	.82	-47	16.6	6.78	134	-18.8	.115	52	.87	-53	.21
1.0	.79	-59	16.2	6.49	124	-17.0	.141	44	.84	-66	.24
1.5	.72	-86	15.3	5.79	100	-14.6	.186	29	.74	-96	.28
2.0	.65	-113	14.2	5.10	77	-13.4	.215	16	.64	-123	.34
2.5	.59	-133	13.0	4.45	61	-12.9	.227	7	.57	-143	.39
3.0	.54	-155	11.6	3.79	42	-12.5	.236	-3	.51	-163	.46
3.5	.53	-174	10.3	3.28	26	-12.4	.239	-14	.45	178	.53
4.0	.52	168	9.2	2.87	10	-12.5	.238	-22	.39	164	.59
4.5	.53	152	8.0	2.51	-4	-12.6	.234	-30	.34	155	.66
5.0	.55	140	6.9	2.21	-17	-12.8	.228	-37	.31	153	.72
5.5	.55	130	5.8	1.94	-31	-13.2	.220	-44	.30	154	.80
6.0	.55	121	4.6	1.70	-43	-13.6	.209	-48	.32	157	.88
6.5	.56	114	3.5	1.50	-53	-13.8	.203	-54	.37	158	.94
7.0	.56	107	2.6	1.34	-63	-14.0	.201	-59	.42	157	.97

Typical Performance, $T_A = 25^\circ\text{C}$

(unless otherwise noted)

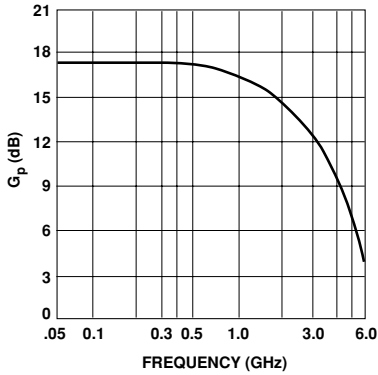

Figure 1. Open Loop Power Gain vs. Frequency, $I_d = 35 \text{ mA}$.

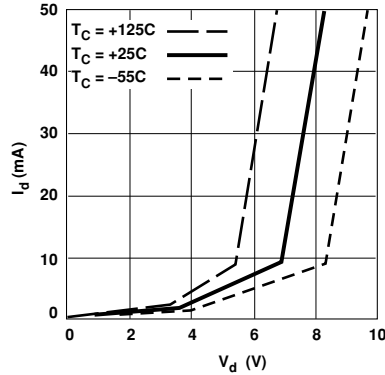

Figure 2. Device Current vs. Voltage.

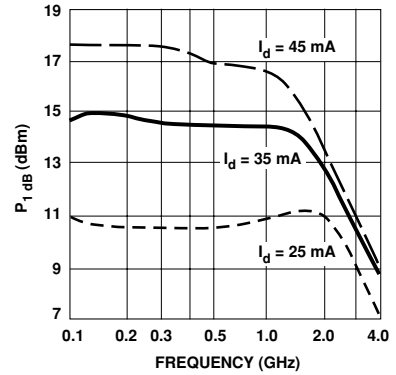

Figure 3. Open Loop Output Power at 1 dB Gain Compression vs. Frequency.

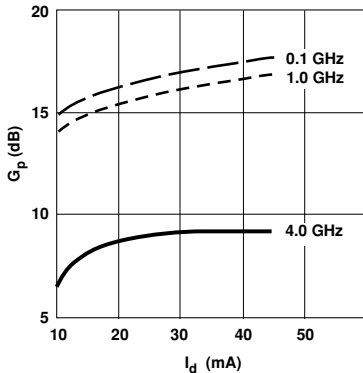

Figure 4. Open Loop Power Gain vs. Current.

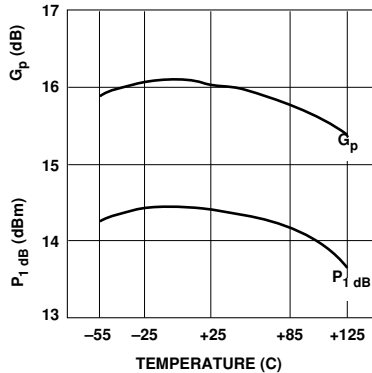
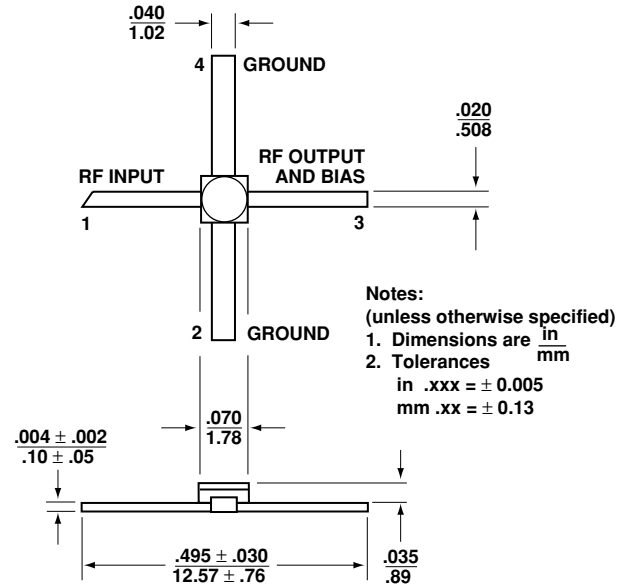

Figure 5. Open Loop Output Power at 1 dB Gain Compression and Open Loop Power Gain vs. Case Temperature, $f = 1.0 \text{ GHz}$, $I_d = 35 \text{ mA}$.

Ordering Information

Part Numbers	No. of Devices	Comments
MSA-9970	100	Bulk

70 mil Package Dimensions



For product information and a complete list of distributors, please go to our web site: www.avagotech.com

Avago, Avago Technologies, and the A logo are trademarks of Avago Technologies, Limited in the United States and other countries. Data subject to change. Copyright © 2008 Avago Technologies, Limited. All rights reserved. Obsoletes 5989-2762EN AV02-1235EN May 15, 2008

AVAGO
TECHNOLOGIES