

40mm sq.

San Ace 40



General Specifications

- Material Frame: Plastics (Flammability: UL94V-0),
Impeller: Plastics (Flammability: UL94V-0)
- Expected Life Refer to specifications (L10: Survival rate: 90% at 60°C ,
rated voltage, and continuously run in a free air state)
- Lead Wire ⊕red ⊖black (Sensor) yellow (Control) brown
- Storage Temperature -30°C to +70°C (Non-condensing)

40×40×20mm (Mass : 35g) **9GA type** High Airflow Low Power Consumption Fan



Specifications

The following nos. have PWM controls, pulse sensors, and ribs.

Model No.	Rated Voltage [V]	Operating Voltage Range [V]	PWM duty cycle* [%]	Rated Current [A]	Rated Input [W]	Rated Speed [min ⁻¹]	Max. Airflow [m ³ /min] [CFM]	Max. Static Pressure [Pa] [inchH ₂ O]	SPL [dB(A)]	Operating Temperature [°C]	Expected Life [h]
9GA0405P6H001 ^(Note)	5	4.5 to 5.5	100	0.35	1.75	12,400	0.33 11.7	191 0.77	40	-20 to +70	40,000/60°C
9GA0405P6F001 ^(Note)			100	0.18	0.9	8,000	0.21 7.4	79.5 0.32	28		60,000/60°C
9GA0412P6G001	12	10.2 to 13.8	100	0.23	2.76	16,000	0.42 14.8	318 1.28	47		40,000/60°C
			0	0.04	0.48	3,800	0.10 3.5	17.9 0.07	14		60,000/60°C
100			0.14	1.68	12,400	0.33 11.7	191 0.77	40			
0			0.04	0.48	3,800	0.10 3.5	17.9 0.07	14			
100			0.08	0.96	8,000	0.21 7.4	79.5 0.32	28			
9GA0412P6F001			0	0.03	0.36	2,200	0.06 2.1	6.0 0.02	10		
9GA0424P6G001 ^(Note)	24	20.4 to 27.6	100	0.13	3.12	16,000	0.42 14.8	318 1.28	47		40,000/60°C
9GA0424P6H001 ^(Note)			100	0.08	1.92	12,400	0.33 11.7	191 0.77	40		60,000/60°C
9GA0424P6F001 ^(Note)			100	0.04	0.96	8,000	0.21 7.4	79.5 0.32	28		

Note: Rated voltage 5V and 24V fans do not rotate when PWM duty cycle is 0%.

*PWM Frequency : 25kHz

Other sensor specifications are available as options. Please refer to the index (p. 504).

Dimensions (unit: mm)

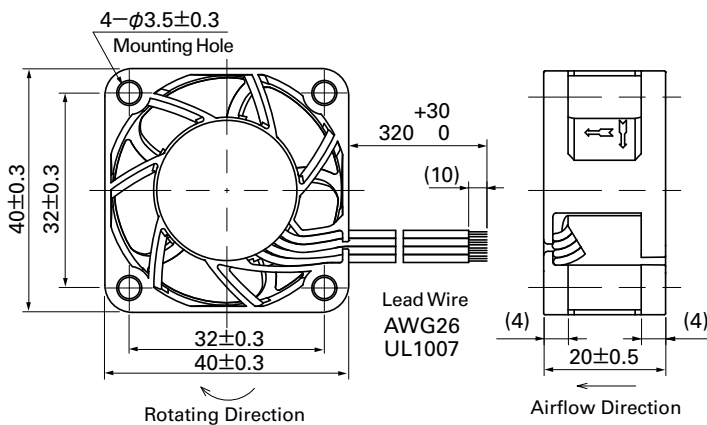

Reference Dimensions of Mounting Holes and Vent Opening (unit: mm)

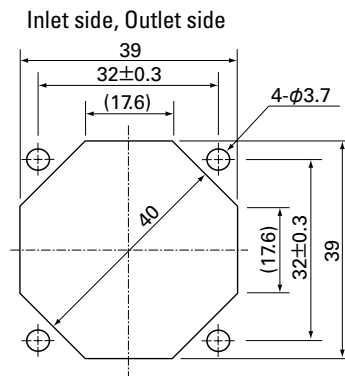

Options (unit: mm)

Finger Guards

Model : 109-059 Surface treatment : Nickel-chrome plating (silver)
 : 109-059H : Cation electropainting (black)

Color

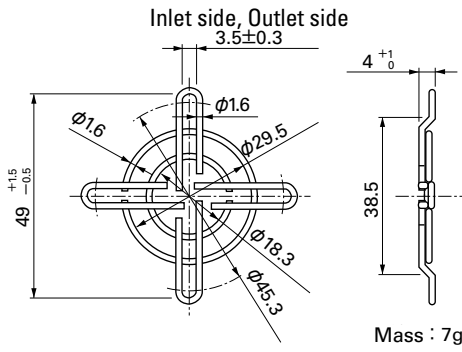

Airflow - Static Pressure Characteristics

PWM Duty Cycle

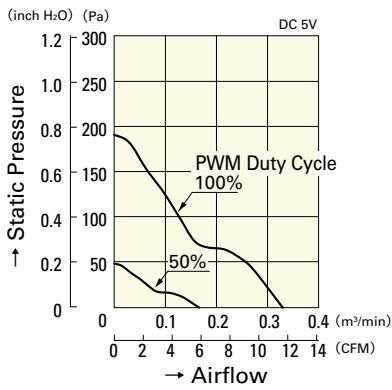

9GA0405P6H001

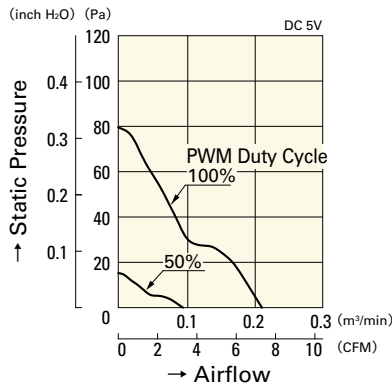

9GA0405P6F001

Operating Voltage Range

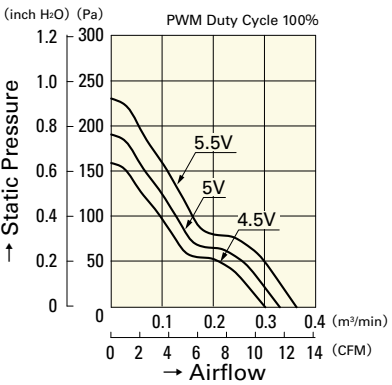

9GA0405P6H001

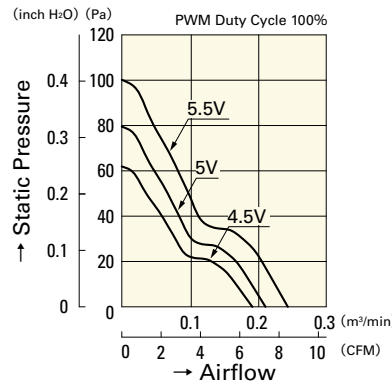

9GA0405P6F001

PWM Duty - Speed Characteristics Example

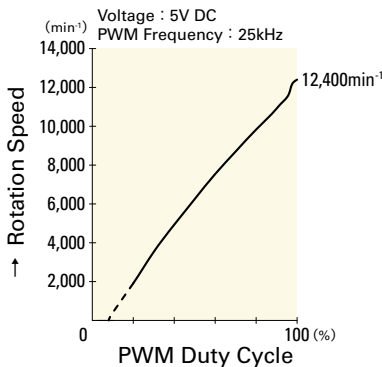

9GA0405P6H001

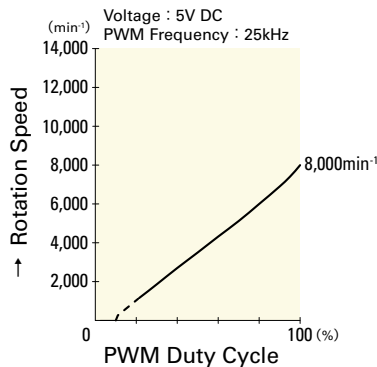

9GA0405P6F001

40mm sq.

San Ace 40

40×40×20mm [Mass : 35g]

Airflow - Static Pressure Characteristics

PWM Duty Cycle

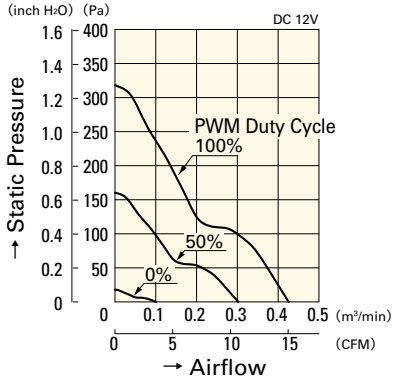

9GA0412P6G001

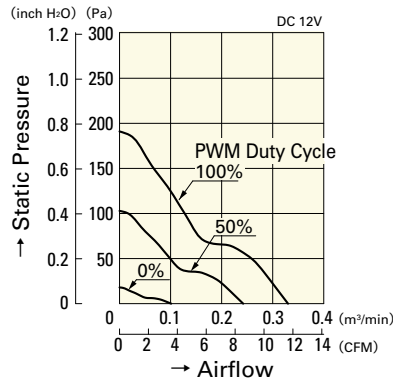

9GA0412P6H001

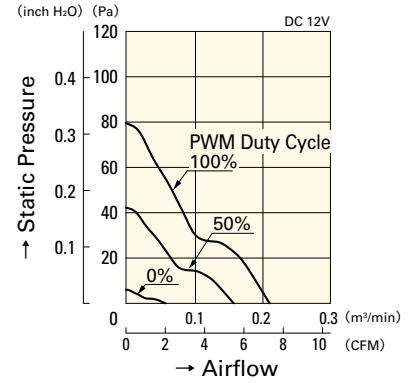

9GA0412P6F001

Operating Voltage Range

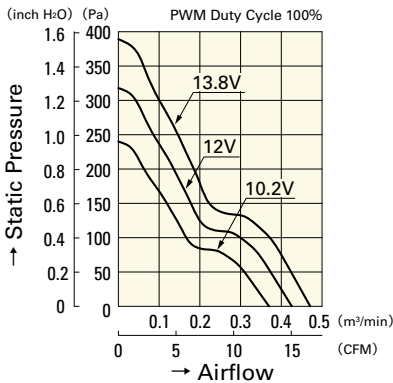

9GA0412P6G001

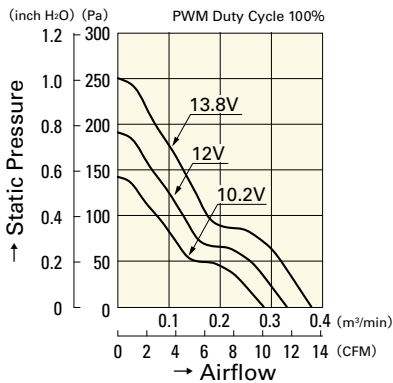

9GA0412P6H001

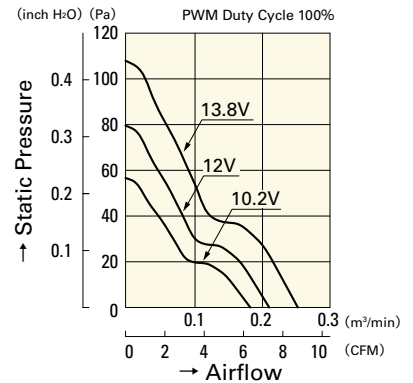

9GA0412P6F001

PWM Duty - Speed Characteristics Example

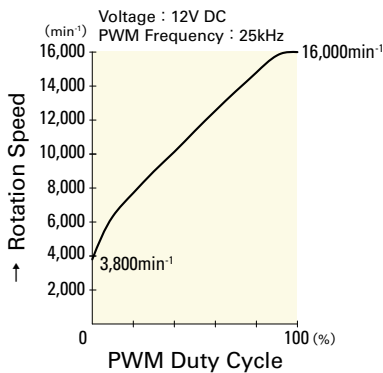

9GA0412P6G001

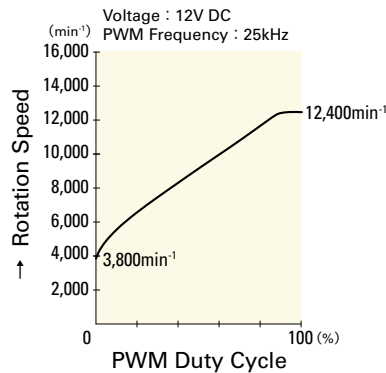

9GA0412P6H001

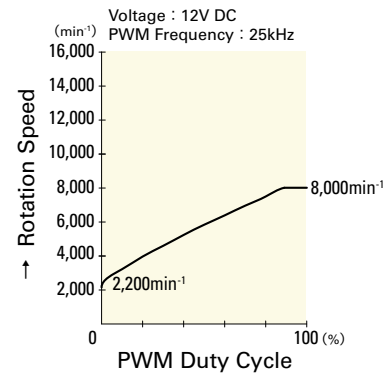

9GA0412P6F001

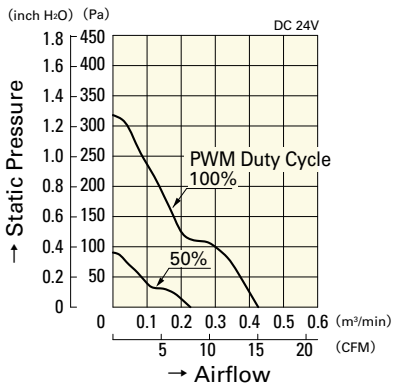

9GA0424P6G001

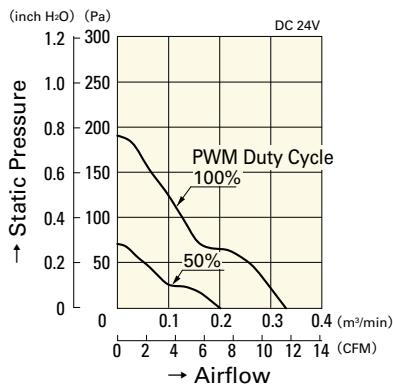

9GA0424P6H001

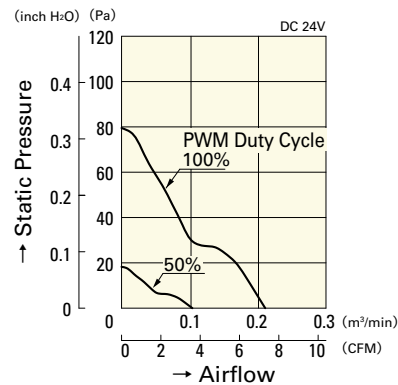

9GA0424P6F001

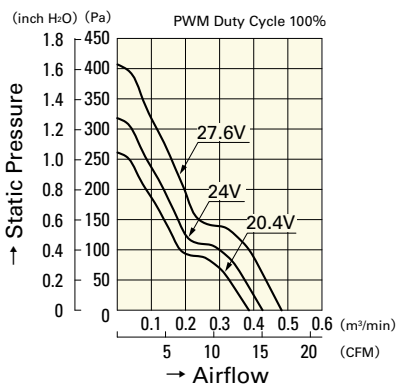

9GA0424P6G001

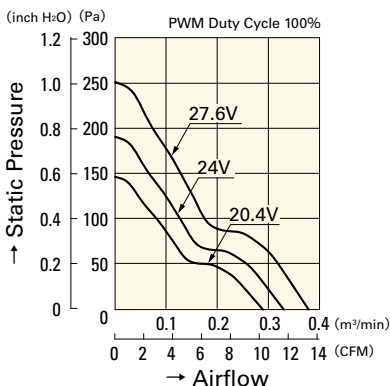

9GA0424P6H001

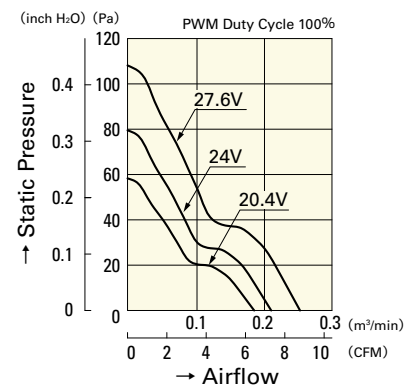

9GA0424P6F001

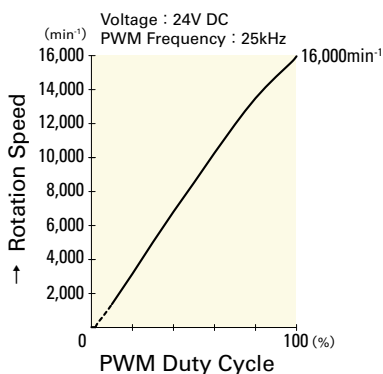

9GA0424P6G001

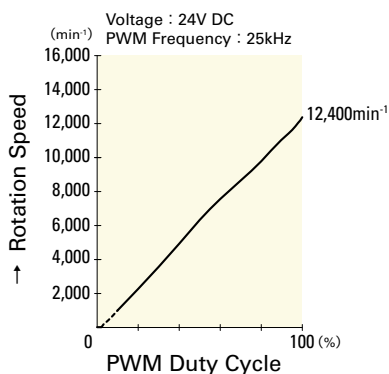

9GA0424P6H001

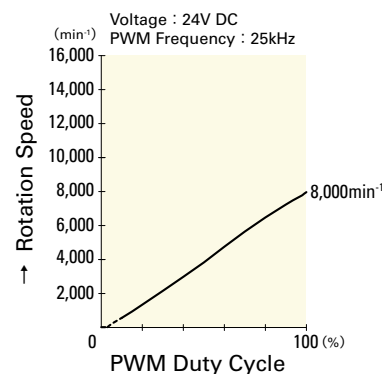

9GA0424P6F001