

8 | 7 | 6 | 5 | 4 | 3 | 2 | 1

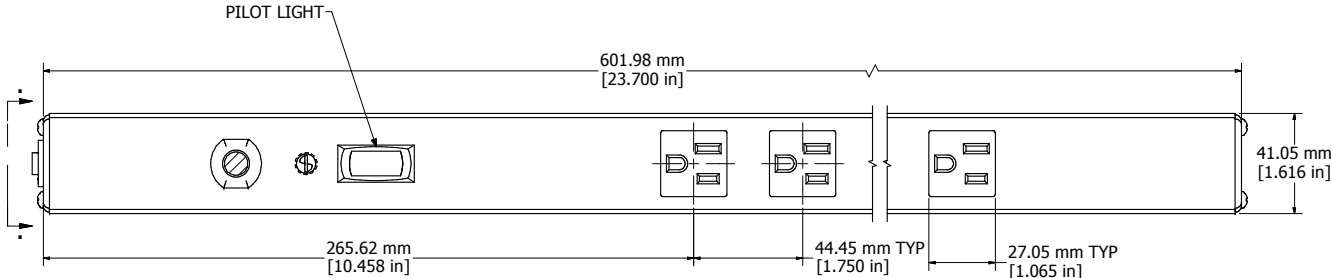

SECTION A-A
(VIEW FROM FRONT)

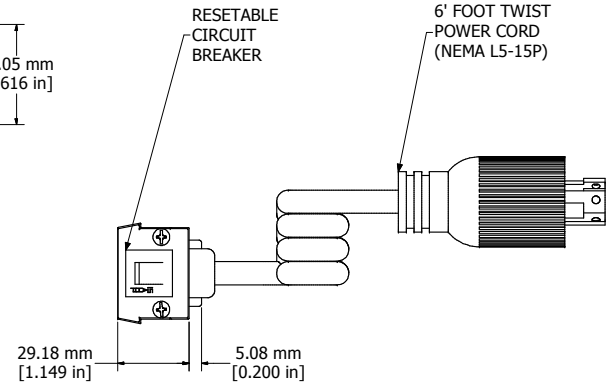

ASSEMBLY - VIEW FROM END

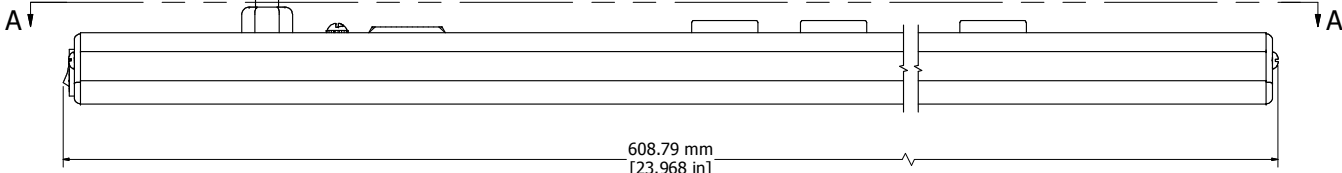

ASSEMBLY - VIEW FROM SIDE

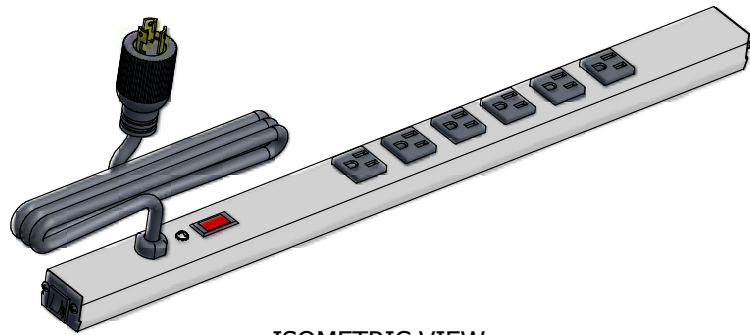

ISOMETRIC VIEW

15852T6C1
Finish - Case - Anodized Aluminum Extrusion
Ends - ABS Plastic
Rated - 125 VAC, 60 Hz, 15 Amps
Approvals - CSA Certified Standards C22.2 (No. 21-95, 42-99) - UL Listed Standard UL1363
Cord Length
15852T6C1 - 6' Foot Twist Power Cord (NEMA L5-15P)
15852T6D1 - 15' Foot Twist Power Cord (NEMA L5-15P)
Accessories Included
Mounting Bracket Kit with Hardware

15852T6C1
www.hammondmfg.com

8 | 7 | 6 | 5 | 4 | 3 | 2 | 1