

User Guide for
FEBFAN6100QMPX_CH07U15A
Evaluation Board

Fairchild W2B Adaptive Charger

Featured Fairchild Products:

FAN501A

FAN6100Q

*Direct questions or comments
about this evaluation board to:
“Worldwide Direct Support”*

Fairchild Semiconductor.com

Table of Contents

1. Introduction.....	3
2. Evaluation Board Specifications.....	4
3. Photographs.....	5
4. Printed Circuit Board.....	6
5. Schematic.....	7
6. Bill of Materials.....	8
7. Transformer and Winding Specifications.....	10
8. Test Conditions & Test Equipment.....	11
9. Performance of Evaluation Board.....	11
9.1. Input Power at No Load Condition.....	11
9.2. Startup Time.....	12
9.3. Input Current.....	12
9.4. DC Output Rising Time.....	13
9.5. Dynamic Response.....	14
9.6. Output Ripple & Noise.....	15
9.7. Short-Circuit Protection (SCP).....	16
9.8. V_{DD} Voltage Level.....	17
9.9. Voltage Stress on MOSFET & Rectifiers.....	17
9.10. Constant Current Regulation.....	18
9.11. Constant Voltage Regulation.....	20
9.12. Efficiency.....	21
9.13. Output Over-Voltage Protection(V_O OVP).....	23
9.14. Bleeder (BLD) Function Test.....	24
9.15. Conducted EMI.....	25
9.16. Qualcomm QC2.0 Compatible Test Result.....	26
9.17. Component Temperature.....	28
10. Appendix.....	32
10.1. Test for 1.5 A Output Current (Fixed Output Current).....	32
11. Revision History.....	34

This user guide supports the evaluation kit for the FAN6100Q. It should be used in conjunction with the FAN6100Q datasheets as well as Fairchild's application notes and technical support team. Please visit Fairchild's website at <https://www.fairchildsemi.com/>

1. Introduction

This document is an engineering report describing a 15 W charger design using FAN501A and FAN6100Q which is for adaptive charger to comply with Qualcomm Quick Charger 2.0 specifications. The output voltages/current adaptively varies between 5 V/2 A, 9 V/1.67 A and 12 V/1.25 A according to protocol command.

The FAN6100Q is a highly integrated secondary side power adaptor controller that is compatible with Qualcomm Quick Charger 2.0. It is designed for use in application that requires constant voltage (CV) and constant current (CC) regulation.

The controller consists of two operational amplifiers for voltage and current loop regulation with adjustable voltage references. The CC control loop also incorporates a current sense amplifier with gain of 10. Outputs of the CV and CC amplifiers are tied together in open drain configuration.

When used in conjunction with primary side PWM controller FAN501A, battery chargers can be implemented to support adaptive output current and output voltage in the range of 5 V/9 V/12 V.

The FAN6100Q enables power adaptor's output voltage adjustment if it detects an adaptive capable powered device. If a non compliant powered device is detected, the controller disables adaptive output voltage to ensure safe operation with smart phone and tablets that support only 5 V.

FAN6100Q also incorporates an internal charge pump circuit to maintain CC regulation down to power supply's output voltage of 2 V without external voltage supply to the IC. Programmable cable drop compensation allows precise CV regulation at end of the cable.

This design shows excellent efficiency satisfying Code of Conduct (CoC) Tier 2 specification while providing ultra low standby power consumption.

This document contains the design specifications, schematics, bill of materials, transformer specifications, PCB layout and performance data.



2. Evaluation Board Specifications

All data for this table was measured with 90 V_{AC}~264 V_{AC} line input at an ambient temperature of 25°C.

Table 1. Summary of Features and Performance

Specification		Min.	Max.	Unit
Input Voltage		90	264	V _{AC}
Input Frequency		47	63	Hz
Description	Mode	Design Spec.	Test Result	Comments
Output Voltage (CV)	5 V	4.75~5.25 V	±0.3%	CV<± 5% Regulation CC<±5% Regulation
	9 V	8.55~9.45 V	±0.1%	
	12 V	11.40~12.60 V	±0.1%	
Output Current (CC)	5 V	0 ~2.0 A	±0.5%	
	9 V	0 ~1.67 A	±0.3%	
	12 V	0 ~1.25 A	±0.2%	
Input Power	5 V	< 30 mW	15.2 mW	264 V _{AC}
Ripple	All	< 150 mVp-p	136 mVp-p (Max.)	Measured at PCB End
Start up time	5 V	<1 S	0.2 S	5 V at Full Load
Dynamic	5 V	>4.5 V at 5 V Mode	4.67 V	Measure at PCB End
	9 V	>8.1 V at 9 V Mode	8.73 V	Measure at PCB End
	12 V	>10.8 V at 12 V Mode	11.79 V	Measure at PCB End
Input Power at Output Short Circuit Protection (SCP)	All	1 W	0.37W (Max.)	264 V _{AC}
Voltage Stress	12 V	640 V	581V	264 V _{AC}
	12 V	60 V	54.3V	264 V _{AC}
Temperature	All	-	101°C at Diode	115 V _{AC} & 230 V _{AC} Full Load Burn in 60 Min.
Efficiency	10% Load	69.73% at 5 V, 74.14% at 9 V,12 V	79.65% at 5 V 79.77% at 9 V 75.99% at 12 V	Meets CoC Tier 2.
	Avg.	79.00% at 5 V, 84.5% at 9 V,12 V	82.05% at 5 V 84.74% at 9 V 84.73% at 12 V	
Conducted EMI	All	Under 6 dB	3 dB Margin	Meets CISPER22B/EN55022B/IE C950/UL1950 Class II

3. Photographs

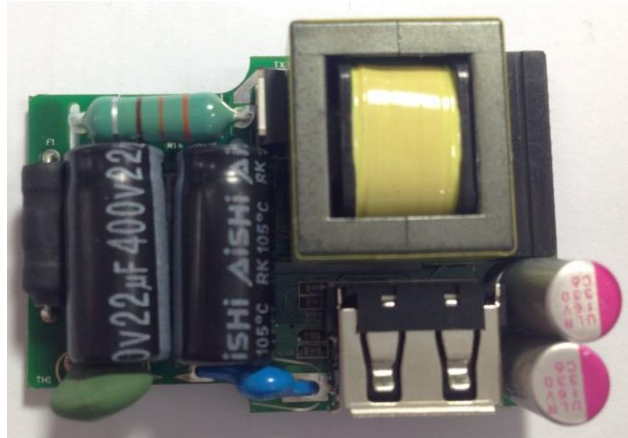

Figure 1. Photograph (W x L :45 x 31 mm²) Top View

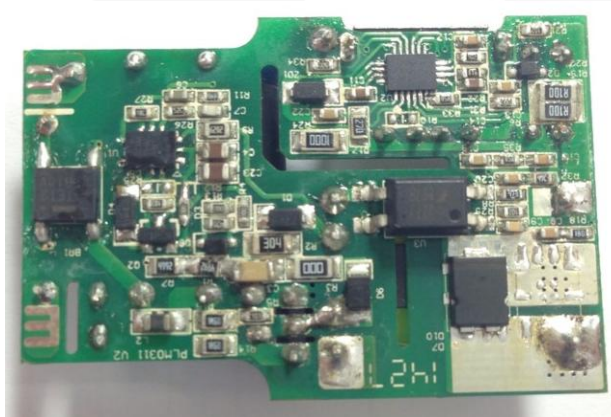

Figure 2. Photograph (W x L :45 x 31 mm²) Bottom View

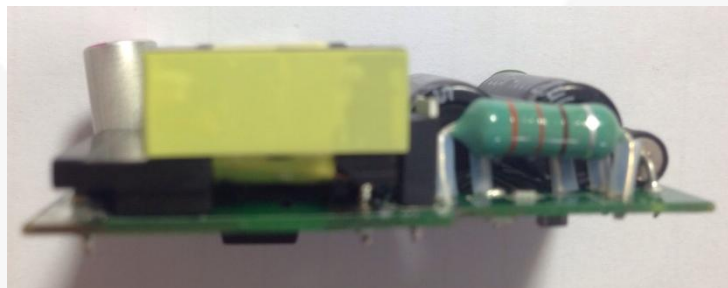

Figure 3. Photograph (H:15 mm) Side View

4. Printed Circuit Board

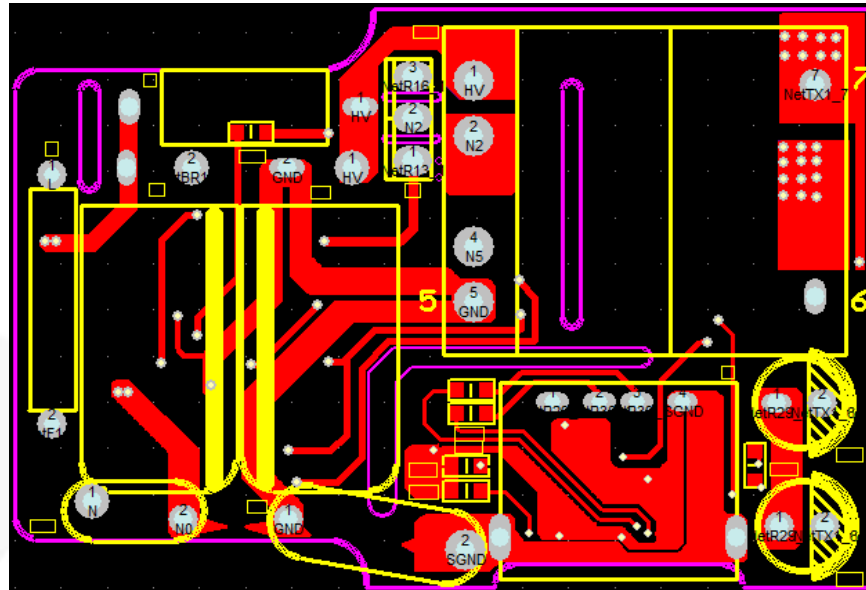

Figure 4. Top View

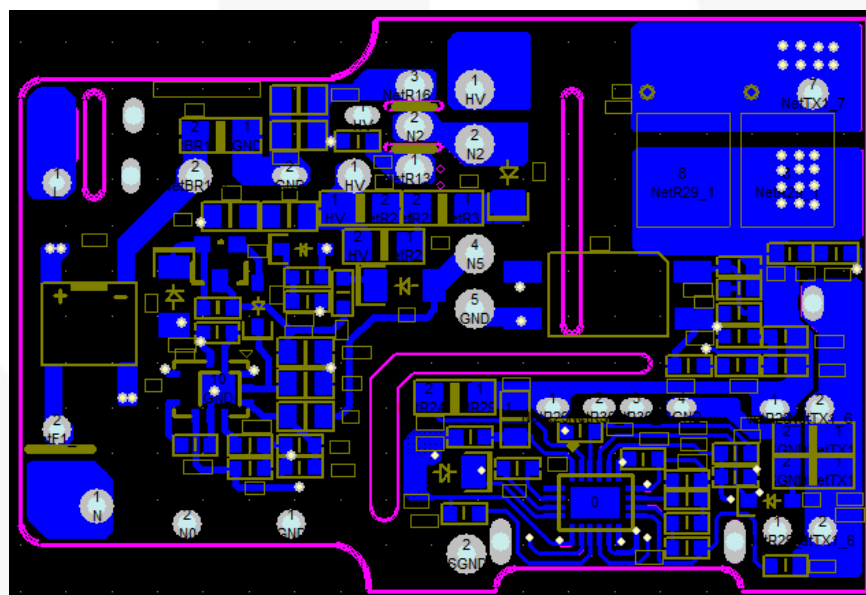

Figure 5. Bottom View

5. Schematic

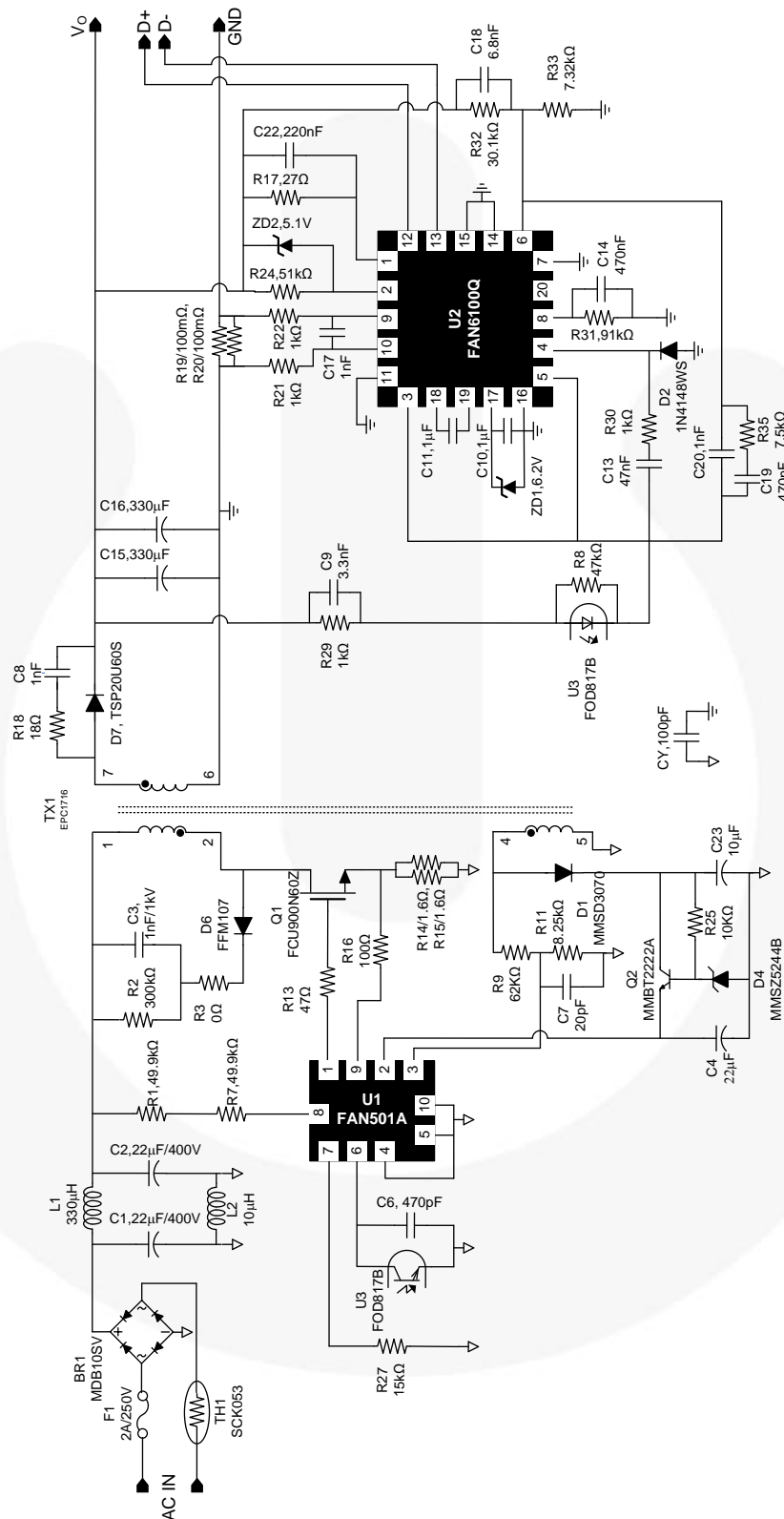

Figure 6. Evaluation Board Schematic



6. Bill of Materials

Part Specification	Package	Qty.	No.
SMD Res. 0603 0 Ω $\pm 5\%$	REEL	2	R34,R36
SMD Res. 0603 18 Ω $\pm 5\%$	REEL	1	R18
SMD Res. 0603 100 Ω $\pm 5\%$	REEL	1	R16
SMD Res. 0603 1 K Ω $\pm 5\%$	REEL	4	R21, R22, R29, R30
SMD Res. 0603 10 K Ω $\pm 5\%$	REEL	2	R5, R25
SMD Res. 0603 8.25 K Ω $\pm 1\%$	REEL	1	R11
SMD Res. 0603 91 K Ω $\pm 1\%$	REEL	1	R31
SMD Res. 0603 47 K Ω $\pm 1\%$	REEL	1	R8
SMD Res. 0603 7.5 K Ω $\pm 5\%$	REEL	1	R35
SMD Res. 0603 7.32 K Ω $\pm 5\%$	REEL	1	R33
SMD Res. 0603 30.1 K Ω $\pm 1\%$	REEL	1	R32
SMD Res. 0603 15 K Ω $\pm 1\%$	REEL	1	R27
SMD Res. 0603 47 Ω $\pm 5\%$	REEL	1	R13
SMD Res. 0805 1.6 Ω $\pm 5\%$	REEL	2	R14, R15
SMD Res. 0805 27 Ω $\pm 1\%$	REEL	1	R17
SMD Res. 0805 49.9 K Ω $\pm 1\%$	REEL	2	R1, R7
SMD Res. 0805 62 K Ω $\pm 1\%$	REEL	1	R9
SMD Res. 1206 0 Ω $\pm 5\%$	REEL	1	R3
SMD Res. 1206 0.1 Ω $\pm 1\%$	REEL	2	R19, R20
SMD Res. 1206 300 K Ω $\pm 5\%$	REEL	1	R2
SMD Res. 1206 51 K ω $\pm 5\%$	REEL	1	R24
SMD inductance 0805 10 μ	REEL	1	L2
Thermistor 8 ψ 5 Ω SCK053	--	1	TH1
0603 NPO $\pm 5\%$ 22P 50 V	REEL	1	C7
0603 X7R $\pm 10\%$ 102P 50 V	REEL	3	C8, C17, C20
0603 $\pm 20\%$ 105P 25 V	REEL	2	C10, C11
0603 X7R $\pm 10\%$ 224P 25 V	REEL	1	C22
0603 X7R $\pm 10\%$ 332P 50 V	REEL	1	C9
0603 X7R $\pm 10\%$ 471P 50 V	REEL	1	C6
0603 X7R $\pm 10\%$ 473P 50 V	REEL	1	C13
0603 X7R $\pm 10\%$ 474P 16 V	REEL	2	C14, C19
0603 X7R $\pm 10\%$ 682P 50 V	REEL	1	C18
0805 X5R $\pm 20\%$ 22 μ F 25 V	REEL	1	C4
1206 X7R $\pm 10\%$ 102P 1K V	REEL	1	C3
Elec. Cap. 22 μ F (0--40%) 400 V 105°C	8*16.5 mm, G-Luxon,GSM126M400T2H5G160	2	C1, C2
0805 X5R $\pm 20\%$ 10 μ F 35 V	REEL	1	C23

Continued on the following page...



Part Specification	Package	Qty.	No.
Y1 Cap 100P 250 V ±20%	D7x7xT9.5 mm	1	CY
Inductor 330 µH ±10%	EC0410-330K	1	L1
OSCON Cap 330 µF 16 V 105°C	6.3*12 mm, ULR337M1CE12R	2	C15,C16
Transformer	EPC1716 SUMIDA	1	TX1
FUSE GLASS 250 V/2 A Fast Blow	3.6*10 mm 36FG(L)R	1	F1
SMD Diode FFM107-M	1 A/1000 V SOD-123	1	D6
SMD TSP20U60S	20 A/60 V	1	D7
Transistor MMBT2222A	NPN General Purpose Amplifier	1	Q2
USB JC0010 4411-02004L	Short Type 10*13 mm	1	J1
SMD Zener 1/2 W 6.2 V	MMSZ5234B Fairchild	1	ZD1
SMD Zener 1/2 W 5.1 V	MMSZ5231B Fairchild	1	ZD2 Parallel on R24
SMD Zener 1/2 W 14V	MMSZ5244B Fairchild	1	D4
SMD Diode 1N4148WS	1 A/100 V SOD-323 Fairchild	1	D2
SMD Diode MMSD3070	1 A/200 V SOD123 Fairchild	1	D1
Bridge diode MDB10SV	1.2 A/1000 V SOIC-4 Fairchild	1	BR1
MOSFET FCU900N60Z	4.5 A/640 V TO-251 Fairchild	1	Q1
FOD817B	SMD-B 4Pin Fairchild	1	U3
IC FAN501AMPX	MLP Fairchild	1	U1
IC FAN6100QMPX	MLP Fairchild	1	U2
PCB PLM0311 REV2	For FAN501A+FAN6100Q 15 W	1	

7. Transformer and Winding Specifications

- Core: EPC1716
- Bobbin: EPC1716 (7 pins)

1. APPEARANCE 1-1. DIMENSION (mm)

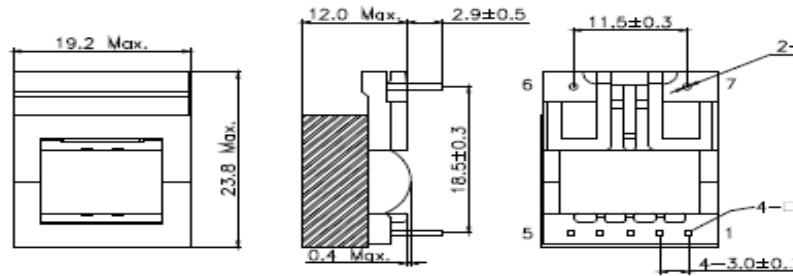

1-2. STAMP

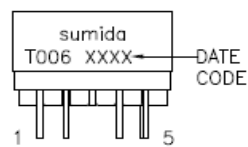

1-3. RECOMMENDED PCB LAYOUT (mm)

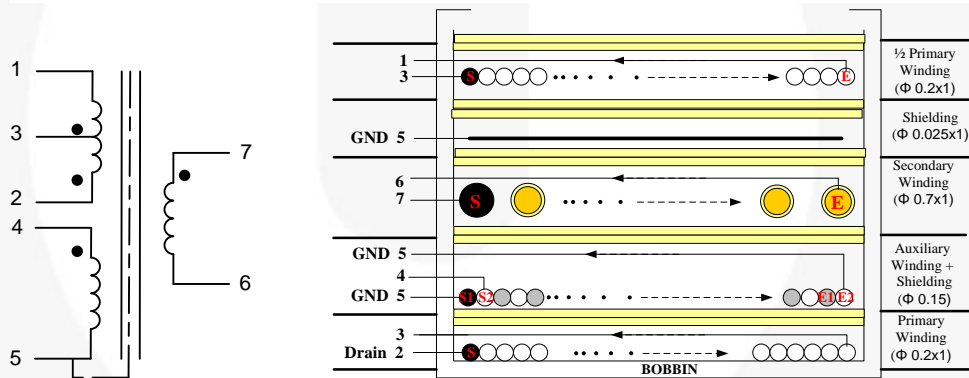
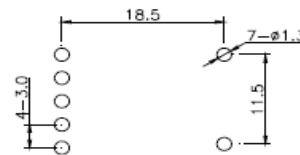

Figure 7. Transformer Specifications & Construction

Table 2. Winding Specifications

Winding	Terminal		Winding	Turns	Isolation Layer
	Start Pin	End Pin			Turns
Np-2	3	1	0.2 mm*1	26	2
Copper Shielding	5	Open	Copper Foil 0.025 mm	1	2
Ns	7	6	0.7 mm*1	6	2
Naux	4	5	0.15 mm*1	11	2
Na-shield	5	Open	0.15 mm*1	11	2
Np-1	2	3	0.2 mm*1	34	2

Bobbin-EPC1716

Table 3. Electrical Characteristics

	Pin	Specification	Remark
Inductance	2 - 1	600 μ H \pm 5%	100 kHz
Effective Leakage	2 - 1	30 μ H Max.	Short Other Pin

8. Test Conditions & Test Equipment

Table 4. Test Conditions & Test Equipment

Evaluation Board #	FEBFAN6100Q_CH07U15A
Test Date	2014-07-04
Test Temperature	25°C
Test Equipments	AC Power Source: 6800 AC POWER SOURCE Electronic Load: Chroma 63030 and 63102 Power Meter : WT210 Oscilloscope : LeCory 24Xs-A

9. Performance of Evaluation Board

9.1. Input Power at No Load Condition

Test Condition:

Measure the input power at three output voltage level at no load condition.

Table 5. Test Result

Input Voltage	$V_o = 5\text{ V}$	$V_o = 9\text{ V}$	$V_o = 12\text{ V}$
90 V_{AC} / 60 Hz	11.5 mW	25.1 mW	41 mW
115 V_{AC} / 60 Hz	11.3 mW	24.9 mW	40 mW
230 V_{AC} / 50 Hz	13 mW	26 mW	42.6 mW
264 V_{AC} / 50 Hz	15.2 mW	27.7 mW	46.4 mW

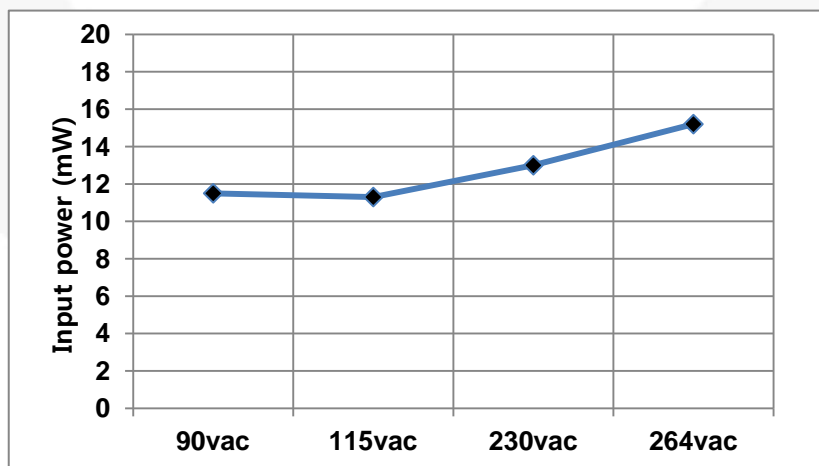

Figure 8. 5 V Input Power Curve

9.2. Startup Time

Test Condition:

Measure the time from AC plug-in to nominal output voltage build-up at full load condition.

Table 6. Test Result

Input Voltage	Startup Time	Specification
90 V _{AC} / 60 Hz	201 ms	<1 sec

Waveform:

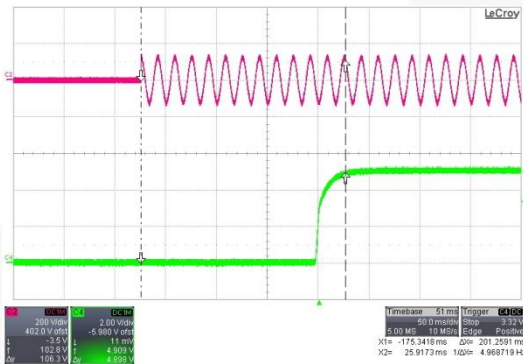

Figure 9. C2[V_{IN}], C4[V_O], 90 V_{AC} / 60 Hz

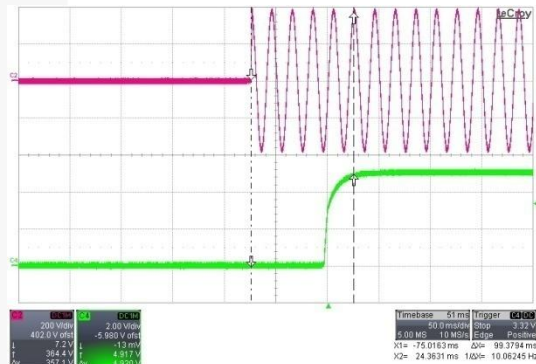

Figure 10. C2[V_{IN}], C4[V_O], 264 V_{AC} / 50 Hz

9.3. Input Current

Test Condition:

Measure the AC input current at 9 V/1.67 A output, where the maximum input power occurs.

Table 7. Test Result

Input Voltage	Input Current	Specification
90 V _{AC} / 60 Hz	349 mA	
264 V _{AC} / 50 Hz	165 mA	

Waveforms:

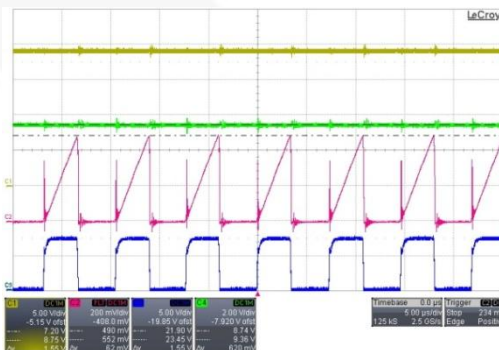

Figure 11. C1[V_{DD}], C2[V_{CS}], C3[GATE], C4[V_O], 90 V_{AC} / 60 Hz

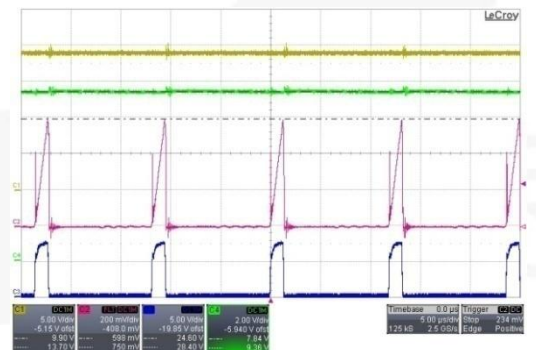

Figure 12. C1[V_{DD}], C2[V_{CS}], C3[GATE], C4[V_O], 264 V_{AC} / 50 Hz

9.4. DC Output Rising Time

Test Condition:

Measure the time interval between 10% to 90% of output voltage during startup (CR mode electric load at 5 V output mode).

Table 8. Test Result

Input Voltage	Minimum Load	Full Load	Specification
90 V _{AC} /60 Hz	26.03 ms	24.12 ms	<30 ms
264 V _{AC} /50 Hz	25.47 ms	23.78 ms	

Waveforms:

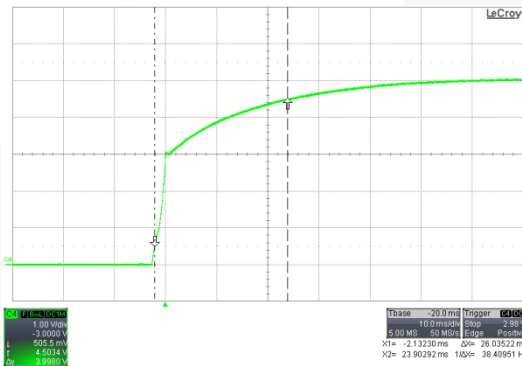

Figure 13. C4[V_O], 90 V_{AC}/60 Hz, Minimum Load

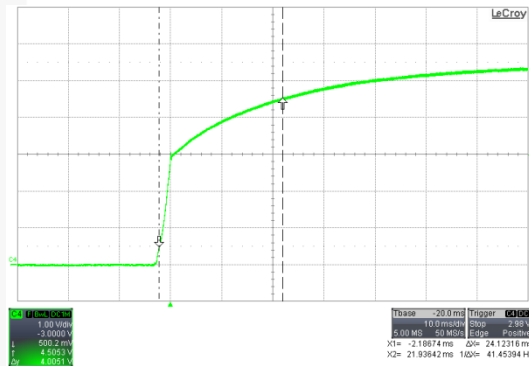

Figure 14. C4[V_O], 90 V_{AC}/60 Hz, Full Load

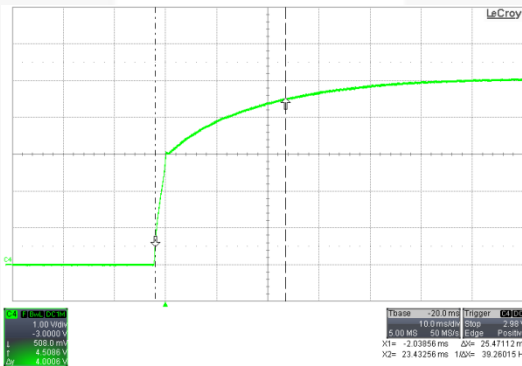

Figure 15. C4[V_O], 264 V_{AC}/50 Hz, Minimum Load

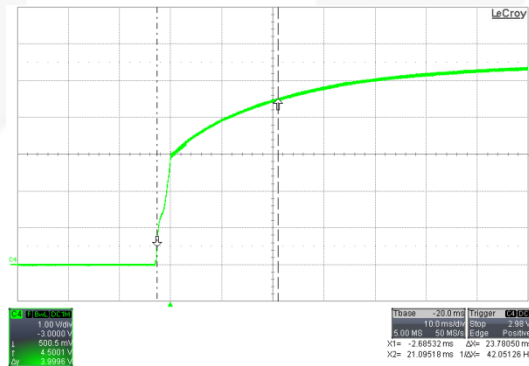

Figure 16. C4[V_O] 264 V_{AC}/50 Hz, Full Load

9.5. Dynamic Response

Test Condition

Dynamic loading (0%~100%), 50% duty cycle (5 ms), 2.5 A/ μ sec rise/fall time. Measured at PCB end.

Table 9. Test Result

$V_o = 5\text{ V}$			
Input Voltage	Overshoot	Undershoot	Specification
90 V _{AC} /60 Hz	5.576 V	4.750 V	> 4.5 V
264 V _{AC} /50 Hz	5.466 V	4.794 V	
$V_o = 9\text{ V}$			
Input Voltage	Overshoot	Undershoot	Specification
90 V _{AC} /60 Hz	9.560 V	8.828 V	>8.1 V
264 V _{AC} /50 Hz	9.512 V	8.912 V	
$V_o = 12\text{ V}$			
Input Voltage	Overshoot	Undershoot	Specification
90 V _{AC} /60 Hz	12.532 V	11.886 V	>10.8 V
264 V _{AC} /50 Hz	12.524 V	11.998 V	

Waveforms:

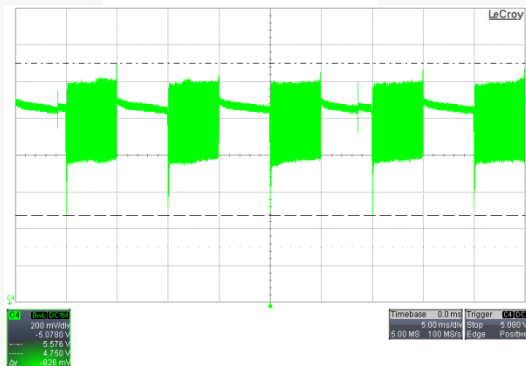

Figure 17. C4[V_o], 90 V_{AC} / 60 Hz, V_o=5 V

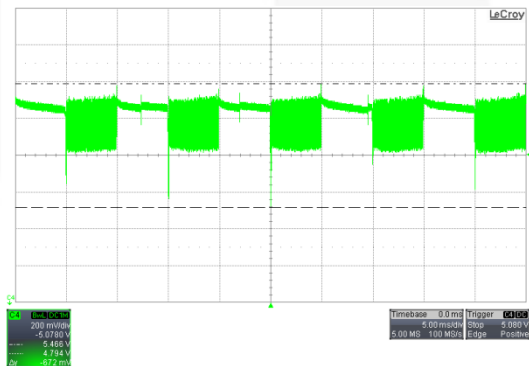

Figure 18. C4[V_o], 264 V_{AC} / 50 Hz, V_o=5 V

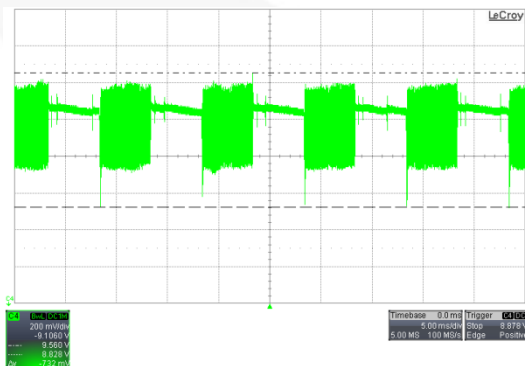

Figure 19. C4[V_o], 90 V_{AC} / 60 Hz, V_o=9 V

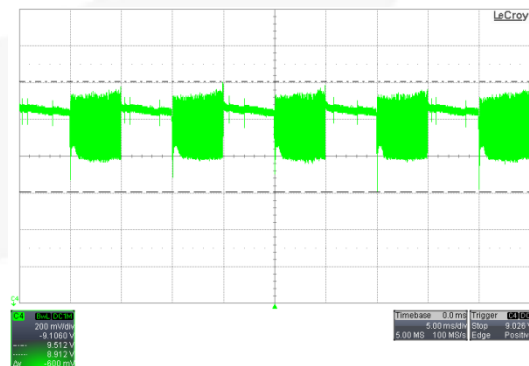

Figure 20. C4[V_o], 264 V_{AC} / 50 Hz, V_o=9 V

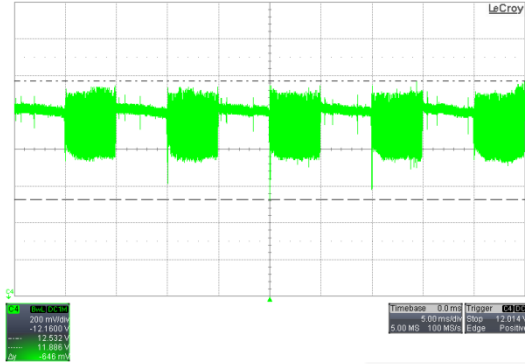

Figure 21. C4[V_O], 90 V_{AC} / 60 Hz, V_O=12 V

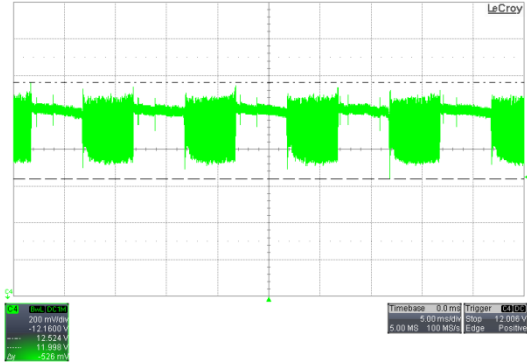

Figure 22. C4[V_O], 264 V_{AC} / 50 Hz, V_O=12 V

9.6. Output Ripple & Noise

Test Condition

Measure the output voltage ripple at full load condition at EVB end with 10 μ F electrolytic capacitor in parallel with 0.1 μ F MLCC.

Table 10. Test Result

Input Voltage	V _O = 5 V	V _O = 9 V	V _O = 12 V	Specification
90 V _{AC} / 60 Hz	103 mV _{P-P}	121 mV _{P-P}	116 mV _{P-P}	<150 mV _{P-P}
115 V _{AC} / 60 Hz	96 mV _{P-P}	115 mV _{P-P}	110 mV _{P-P}	
230 V _{AC} / 50 Hz	106 mV _{P-P}	136 mV _{P-P}	125 mV _{P-P}	
264 V _{AC} / 50 Hz	108 mV _{P-P}	130 mV _{P-P}	125 mV _{P-P}	

Waveforms:

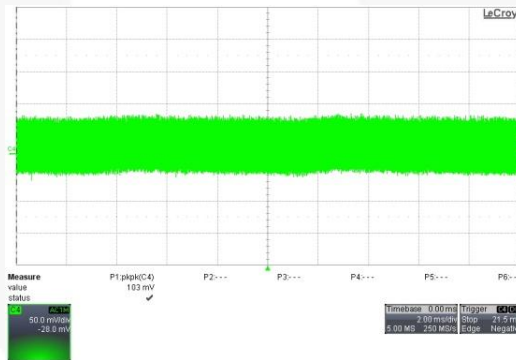

Figure 23. C4[V_O], 90 V_{AC} / 60 Hz, I_O=2 A, V_O=5 V

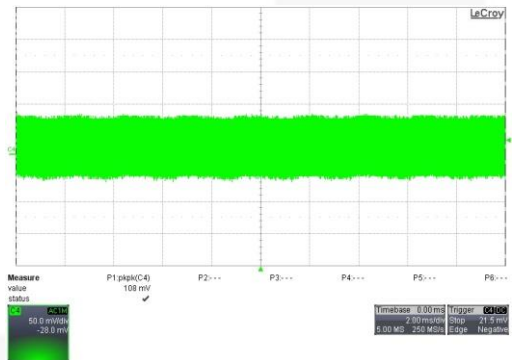

Figure 24. C4[V_O], 264 V_{AC} / 50 Hz, I_O=2 A, V_O=5 V

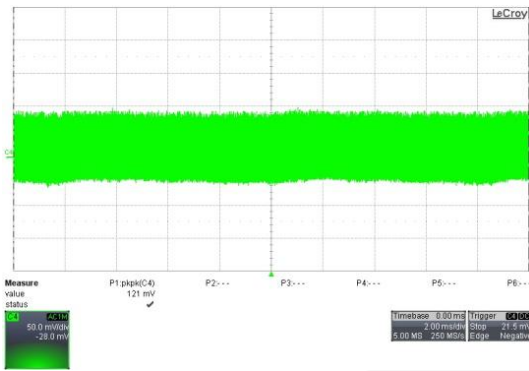

Figure 25. C4[V_O], 90 V_{AC} / 60 Hz, I_O=1.8 A, V_O=9 V

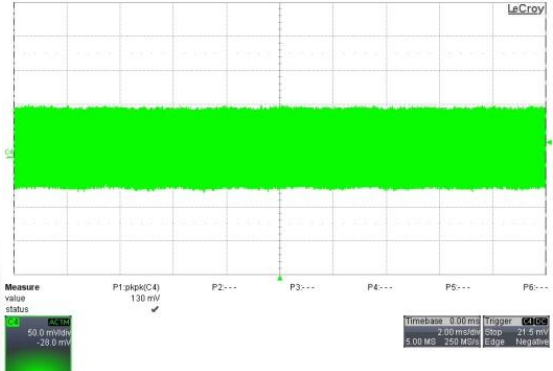

Figure 26. C4[V_O], 264 V_{AC} / 50 Hz, I_O=1.8 A, V_O=9 V

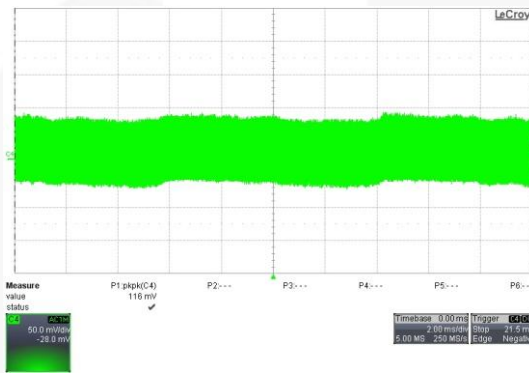

Figure 27. C4[V_O], 90 V_{AC} / 60 Hz, I_O=1.67 A, V_O=12 V

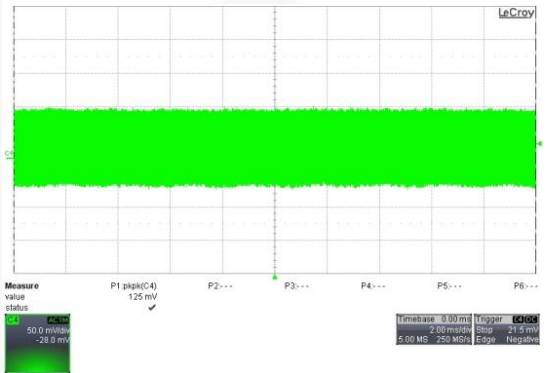

Figure 28. C4[V_O], 264 V_{AC} / 50 Hz, I_O=1.67 A, V_O=12 V

9.7. Short-Circuit Protection (SCP)

Test Condition

Short output voltage, then the power supply should enter hiccup mode protection with less than 1 W input power. 5 V, 9 V and 12 V mode has the same power loss at this condition.

Table 11. Test Result with Input Power

	Maximum Output Load	Minimum Output Load	Specification
90 V _{AC} / 60 Hz	0.18 W	0.18 W	<1 W
264 V _{AC} / 50 Hz	0.37 W	0.35 W	

Waveforms:



Figure 29. C2[V_{Cs}], C4[V_O], 264 V_{AC}/50 Hz, I_O=0 A, V_O=12 V

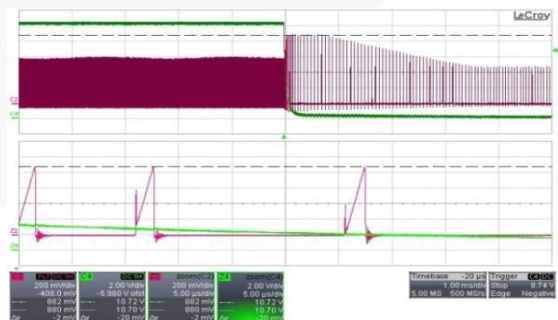

Figure 30. C2[V_{Cs}], C4[V_O], 264 V_{AC}/50 Hz, I_O=1.25 A, V_O=12 V

9.8. V_{DD} Voltage Level

Test Condition:

Measure VDD level at 5 V and 12 V system in minimum load and CC point.

Table 12. Test Result

$V_O = 5\text{ V}$			
Input Voltage	Minimum Load	CC Point	Specification
90 V_{AC} / 60 Hz	7.14 V	13.1 V	<26.5 V
264 V_{AC} / 50 Hz	7.10 V	13.1 V	
$V_A = 12\text{ V}$			
Input Voltage	Minimum Load	CC Point	Specification
90 V_{AC} / 60 Hz	12.8 V	13.1 V	<26.5 V
264 V_{AC} / 50 Hz	12.8 V	13.1 V	

Waveforms:

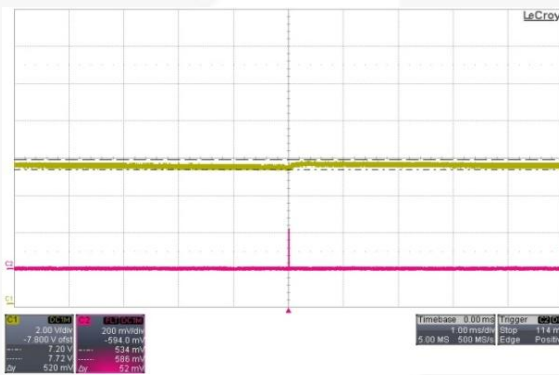

Figure 31. C1[V_{DD}], C2[V_{CS}], 90 V_{AC} /60 Hz.
0 A, $V_O=5\text{ V}$

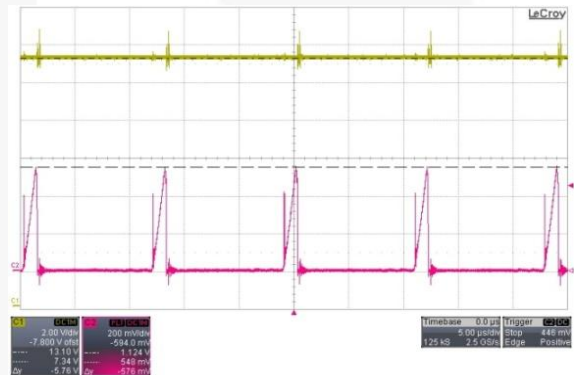

Figure 32. C1[V_{DD}], C2[V_{CS}] 264 V_{AC} /50 Hz,
2.3 A, $V_O=5\text{ V}$

9.9. Voltage Stress on MOSFET & Rectifiers

Test Condition

Measure the voltage and current stress on MOSFET and secondary rectifier under below the conditions in 12 V mode where the maximum voltage stress occurs.

Table 13. Test Result

		90 V_{AC} / 60 Hz		264 V_{AC} / 50 Hz		Specification
		Min. Load	Full Load	Min. Load	Full Load	
Normal	MOSFET	267 V	318 V	530 V	576 V	$V_{DS}<640\text{ V}$ $V_D<60\text{ V}$
	Rectifier	27.3 V	35.2 V	53.6 V	54.3 V	
Short Circuit	MOSFET	272 V	320 V	534 V	581 V	
	Rectifier	27.3 V	35.3 V	53.9 V	54.3 V	

Waveforms:

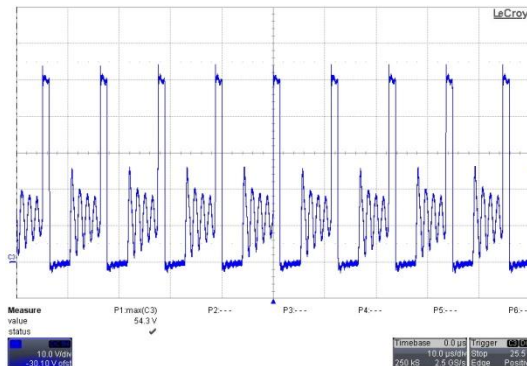

Figure 33. C3[V_{DS}], 264 V_{AC}/50 Hz, 12 V, Full Load

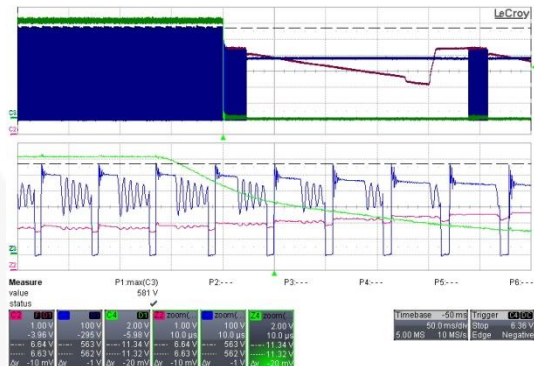

Figure 34. C2[FB], C3[V_{bs}], C4[Vo] 264 V_{AC}/50 Hz, 12 V, Full Load Output Short

9.10. Constant Current Regulation

Test Condition

Aging five seconds at minimum load and measure the output current and output voltage each load / one second interval. Electric load is in CV mode.

Table 14. Test Result with CC

V _O = 5 V (Until 3 V)				
Input Voltage	Maximum Current	Minimum Current	Tolerance	Specification
90 V _{AC} / 60 Hz	2372.81 mA	2357.81 mA	±0.4%	< ±5%
115 V _{AC} / 60 Hz	2367.18 mA	2352.18 mA	±0.4%	
230 V _{AC} / 50 Hz	2366.25 mA	2351.25 mA	±0.4%	
264 V _{AC} / 50 Hz	2369.06 mA	2355.00 mA	±0.4%	
Total	2372.81 mA	2351.25 mA	±0.5%	
V _O = 9 V (Until Enter UVP Point)				
Input Voltage	Maximum Current	Minimum Current	Tolerance	Specification
90 V _{AC} / 60 Hz	1875.00 mA	1869.37 mA	±0.2%	< ±5%
115 V _{AC} / 60 Hz	1873.12 mA	1868.43 mA	±0.1%	
230 V _{AC} / 50 Hz	1871.25 mA	1877.81 mA	±0.1%	
264 V _{AC} / 50 Hz	1877.81 mA	1873.12 mA	±0.1%	
Total	1877.81 mA	1866.56 mA	±0.3%	
V _O = 12 V (Until Enter UVP Point)				
Input Voltage	Maximum Current	Minimum Current	Tolerance	Specification
90 V _{AC} / 60 Hz	1379.06 mA	1378.12 mA	±0.1%	< ±5%
115 V _{AC} / 60 Hz	1379.06 mA	1377.18 mA	±0.1%	
230 V _{AC} / 50 Hz	1378.12 mA	1376.25 mA	±0.1%	
264 V _{AC} / 50 Hz	1377.18 mA	1375.31 mA	±0.1%	
Total	1379.06 mA	1375.31 mA	±0.2%	

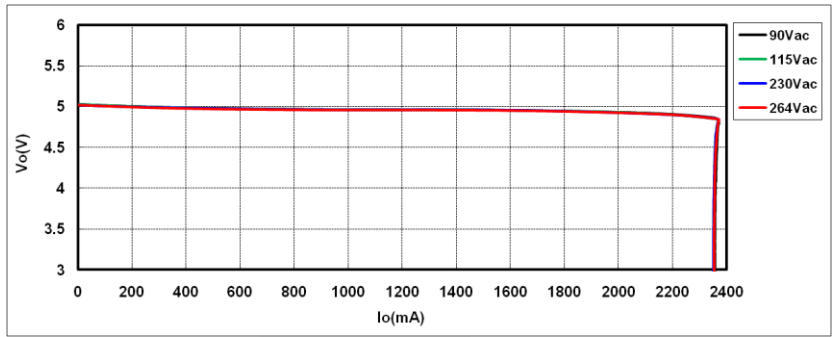

Figure 35. 5 V CC Deviation Curve

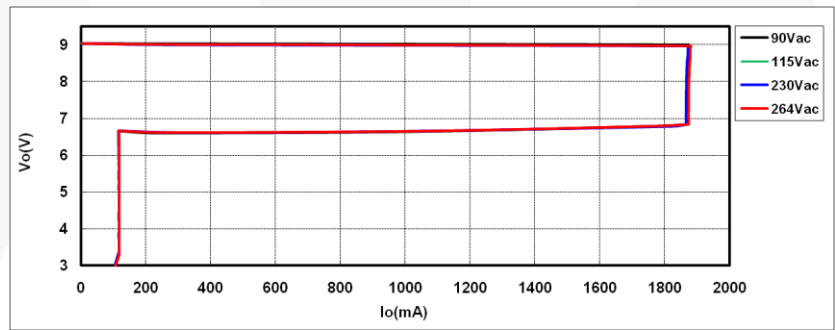

Figure 36. 9 V CC Deviation Curve

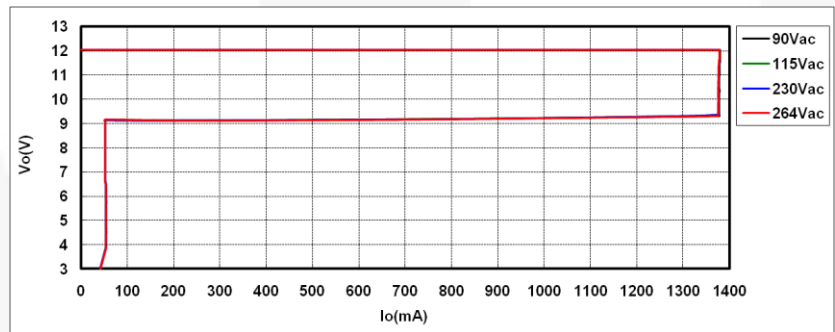

Figure 37. 12 V CC Deviation Curve

9.11. Constant Voltage Regulation

Test Condition

Aging five seconds at minimum load and measure the output current and output voltage each load / one second interval. Electric load is in CR mode.

Table 15. Test Result with CV

$V_O = 5\text{ V}$				
Input Voltage	Maximum Voltage	Minimum Voltage	Tolerance	Specification
90 V _{AC} / 60 Hz	5.026 V	5.015 V	±0.1%	< ±5%
115 V _{AC} / 60 Hz	5.033 V	5.021 V	±0.1%	
230 V _{AC} / 50 Hz	5.037 V	5.021 V	±0.2%	
264 V _{AC} / 50 Hz	5.041 V	5.021 V	±0.2%	
Total	5.041 V	5.021 V	±0.3%	
$V_O = 9\text{ V}$				
Input Voltage	Maximum Voltage	Minimum Voltage	Tolerance	Specification
90 V _{AC} / 60 Hz	9.06 V	9.037 V	±0.1%	< ±5%
115 V _{AC} / 60 Hz	9.06 V	9.036 V	±0.1%	
230 V _{AC} / 50 Hz	9.061 V	9.038 V	±0.1%	
264 V _{AC} / 50 Hz	9.061 V	9.038 V	±0.1%	
Total	9.061 V	9.036 V	±0.1%	
$V_O = 12\text{ V}$				
Input Voltage	Maximum Voltage	Minimum Voltage	Tolerance	Specification
90 V _{AC} / 60 Hz	12.051 V	12.034 V	±0.1%	< ±5%
115 V _{AC} / 60 Hz	12.051 V	12.033 V	±0.1%	
230 V _{AC} / 50 Hz	12.052 V	12.035 V	±0.1%	
264 V _{AC} / 50 Hz	12.052 V	12.035 V	±0.1%	
Total	12.052 V	12.033 V	±0.1%	

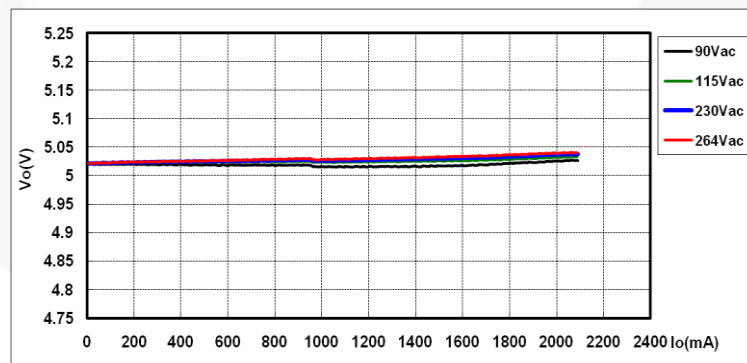

Figure 38. 5 V CV Deviation Curve

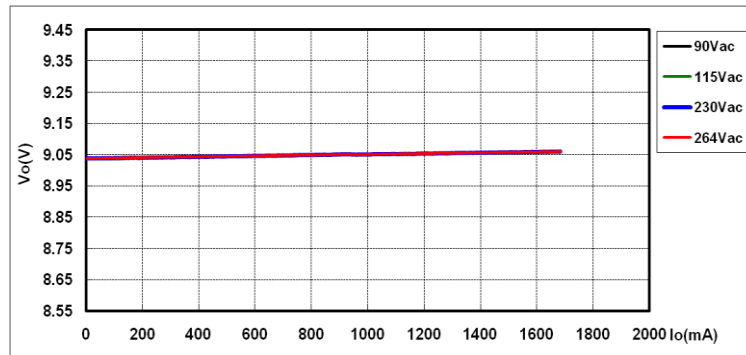

Figure 39. 9 V CV Deviation Curve

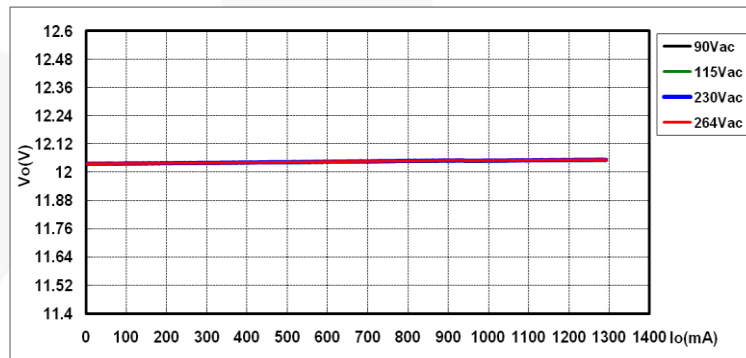

Figure 40. 12 V CV Deviation Curve

9.12. Efficiency

Test Condition

Measure input wattage and output wattage at PCB end. Average efficiency is obtained from 25%, 50%, 75% and 100% load condition.

Table 16. Test Result

$V_o = 5\text{ V}$							
Input Voltage	10%	25%	50%	75%	100%	Avg.	Specification
90 V _{AC} / 60 Hz	83.19%	83.47%	83.35%	83.56%	83.23%	83.40%	CoC Tier 2: 115 V _{AC} /230 V _{AC} Average >79% 10% >69.73%
115 V _{AC} / 60 Hz	83.40%	83.83%	83.71%	84.71%	83.28%	83.88%	
230 V _{AC} / 50 Hz	80.62%	81.68%	82.69%	83.76%	83.79%	82.98%	
264 V _{AC} / 50 Hz	79.65%	80.85%	81.25%	83.02%	83.08%	82.05%	
$V_o = 9\text{ V}$							
Input Voltage	10%	25%	50%	75%	100%	Avg.	Specification
90 V _{AC} / 60 Hz	80.97%	83.84%	86.26%	86.29%	84.94%	85.33%	CoC Tier2: 115 V _{AC} /230 V _{AC} Average >84.51% 10% >74.14%
115 V _{AC} / 60 Hz	82.51%	84.21%	85.21%	86.34%	86.67%	85.61%	
230 V _{AC} / 50 Hz	80.62%	82.94%	85.33%	86.34%	86.82%	85.36%	
264 V _{AC} / 50 Hz	79.77%	81.95%	84.50%	85.91%	86.58%	84.74%	
$V_o = 12\text{ V}$							
Input Voltage	10%	25%	50%	75%	100%	Avg.	Specification
90 V _{AC} / 60 Hz	77.21%	81.45%	84.67%	86.34%	86.45%	84.73%	CoC Tier2: 115 V _{AC} /230 V _{AC} Average >84.50% 10% >74.13%
115 V _{AC} / 60 Hz	79.03%	83.48%	86.13%	85.88%	86.88%	85.59%	
230 V _{AC} / 50 Hz	76.76%	81.94%	85.79%	86.74%	87.63%	85.52%	
264 V _{AC} / 50 Hz	75.99%	81.14%	84.65%	86.07%	87.13%	84.75%	

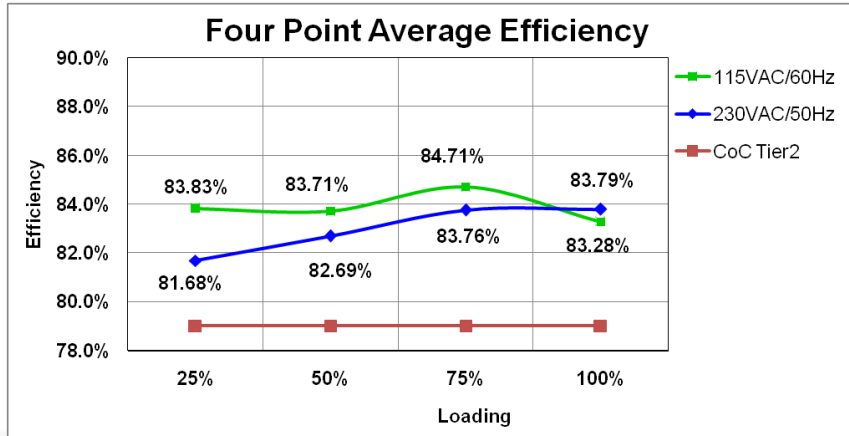

Figure 41. 5 V Efficiency Curve (4 Point Average: 100%, 75%, 50%, 25%)

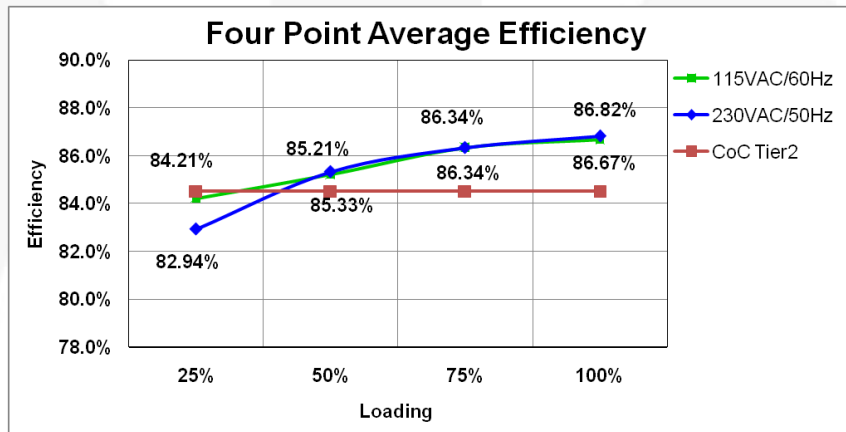

Figure 42. 9 V Efficiency Curve (4 Point Average: 100%, 75%, 50%, 25%)

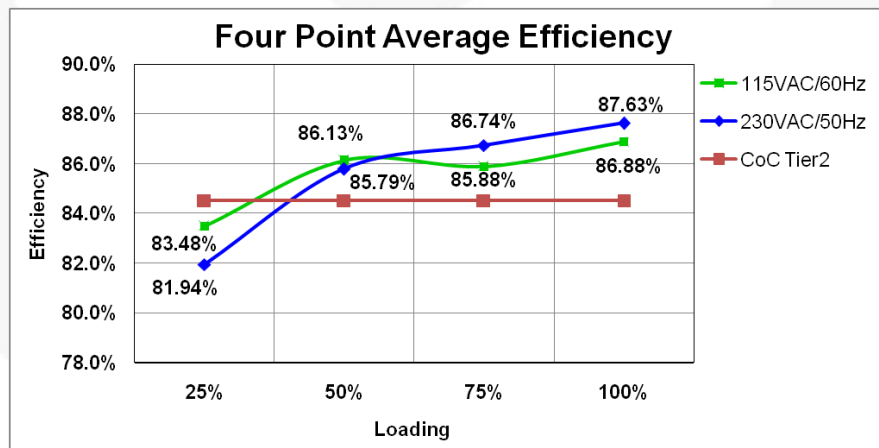

Figure 43. 12 V Efficiency Curve (4 Point Average: 100%, 75%, 50%, 25%)

9.13. Output Over-Voltage Protection(V_o OVP)

Test Condition

Measure the maximum output voltage when second side VREF resistor is open. When V_o OVP is triggered, OVP signal is pulled low, pulling down FB signal. $V_o = 5$ V.

Table 17. Test Results

Input Voltage	Minimum Load	Maximum Load	Specification
90 V _{AC} / 60 Hz	6.27 V	7.38 V	
264 V _{AC} / 50 Hz	6.27 V	7.38 V	
$V_o = 9$ V			
Input Voltage	Minimum Load	Maximum Load	Specification
90 V _{AC} / 60 Hz	11.5 V	12 V	
264 V _{AC} / 50 Hz	11.5 V	12 V	
$V_o = 12$ V			
Input Voltage	Minimum Load	Maximum Load	Specification
90 V _{AC} / 60 Hz	14.8 V	15.3 V	<16 V
264 V _{AC} / 50 Hz	14.6 V	15.3 V	

Waveforms:

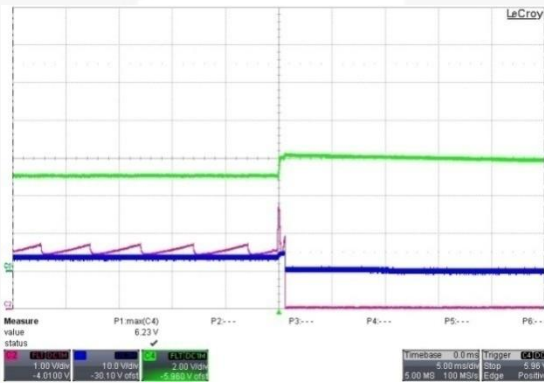

Figure 44. $C2[V_{FB}]$ $C3[V_{OVP}]$ $C4[V_o]$
 V_o OVP Test, 5 V

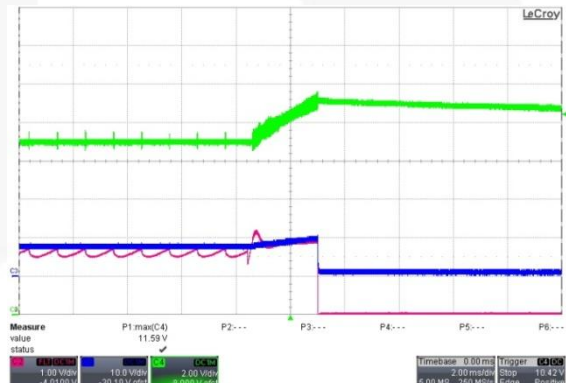

Figure 45. $C2[V_{FB}]$ $C3[V_{OVP}]$ $C4[V_o]$
 V_o OVP Test, 9 V

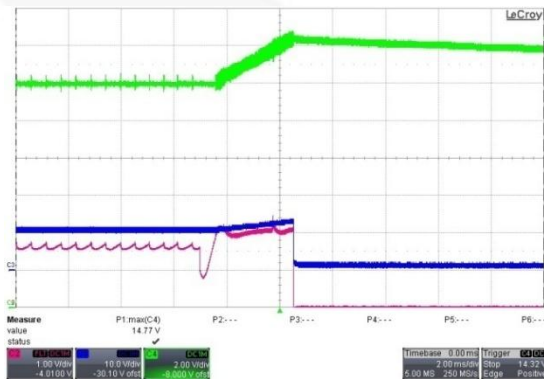

Figure 46. $C2[V_{FB}]$ $C3[V_{OVP}]$ $C4[V_o]$
 V_o OVP Test, 12 V

9.14. Bleeder (BLD) Function Test

Test Condition

Measure time when mode changes from high voltage to low voltage. Function turns on for 320 ms to discharge output voltage.

Table 18. Test Result

Mode Change	Change Time
9 V → 5 V	67.88 ms
12 V → 5 V	75.52 ms
12 V → 9 V	59.74 ms

Waveforms:

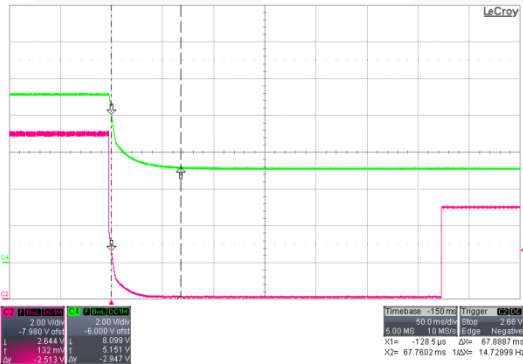

Figure 47. C2[V_{BLD}], C4[V_O] 90 V_{AC} / 60 Hz & I_O=0 A, 9 V to 5 V

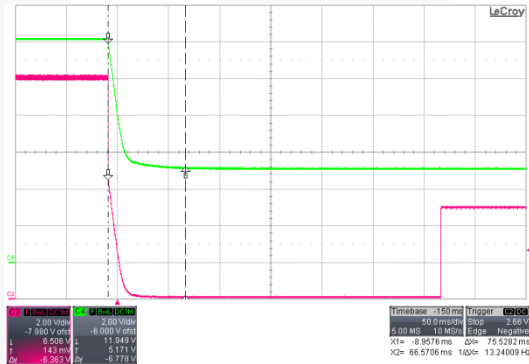

Figure 48. C2[V_{BLD}], C4[V_O] 90 V_{AC} / 60 Hz & I_O=0 A, 12 V to 5 V

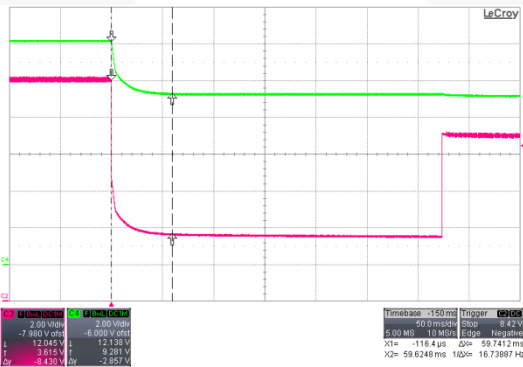

Figure 49. 90 V_{AC} / 60 Hz & I_O=0 A, 12 V to 9 V

9.15. Conducted EMI

Test Condition

- Frequency Range: 150 kHz – 30 MHz, Probe: 2-Line-LISN ENV216
- Signal Path: Receiver-2-Line-LISN ENV216, Detectors: Average
- IF Bandwidth: 9 kHz, Step Size: 0.4%, Meas. Time: 0.1 s, Preamp: 0 dB
- Output Load: 5 V=> 2.5 Ω, 9 V=> 5.39 Ω, 12 V=> 9.6 Ω.

Test Result

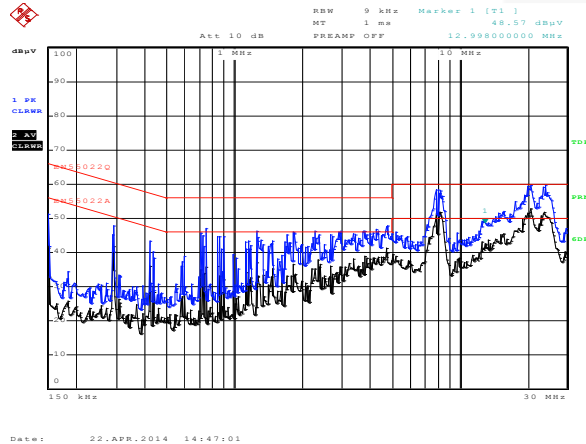

Figure 50. Line: 115 V_{AC} / 60 Hz & 5 V_O

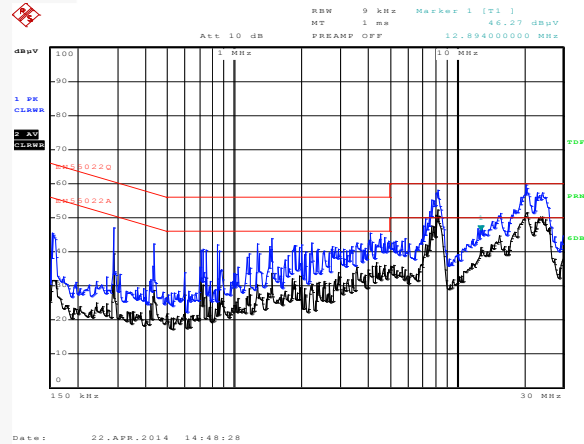

Figure 51. Neutral: 115 V_{AC} / 60 Hz & 5 V_O

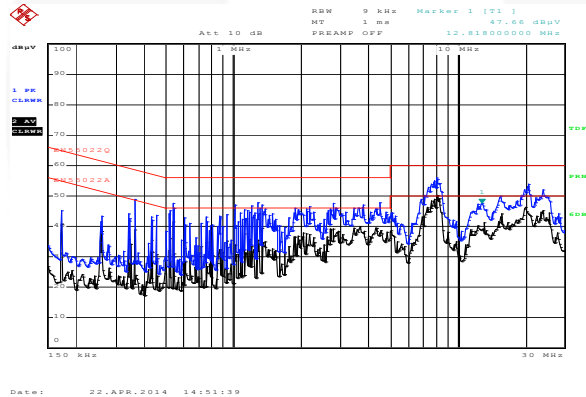

Figure 52. Line: 230 V_{AC} / 50 Hz & 5 V_O

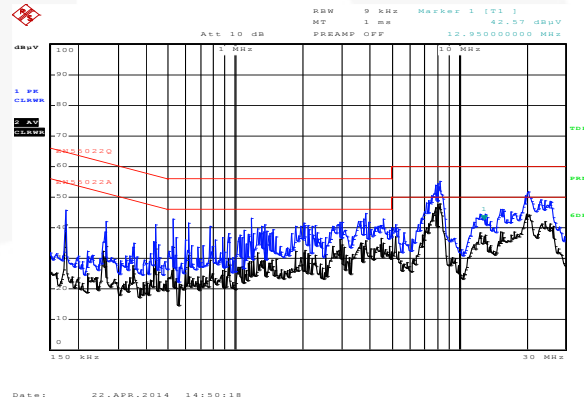

Figure 53. Neutral: 230 V_{AC} / 50 Hz & 5 V_O

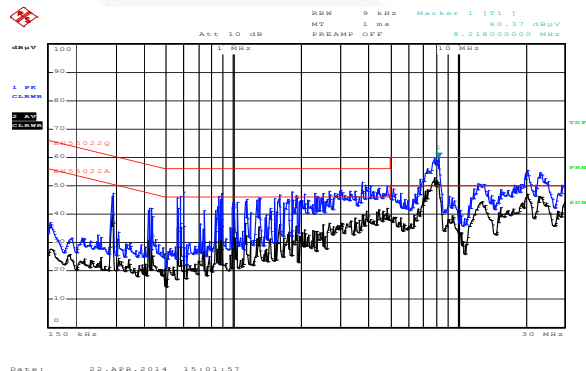

Figure 54. Line: 115 V_{AC} / 60 Hz & 9 V_O

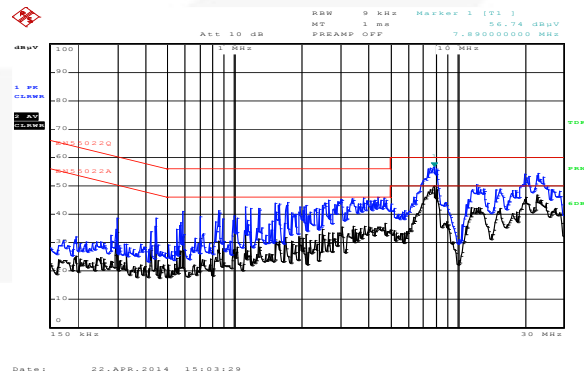

Figure 55. Neutral: 115 V_{AC} / 60 Hz & 9 V_O

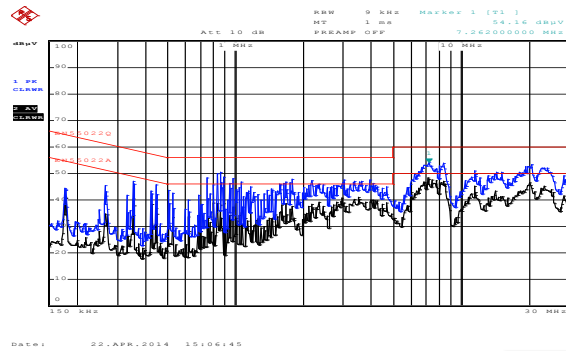

Figure 56. Line: 230 V_{AC} / 50 Hz & 9 V_O

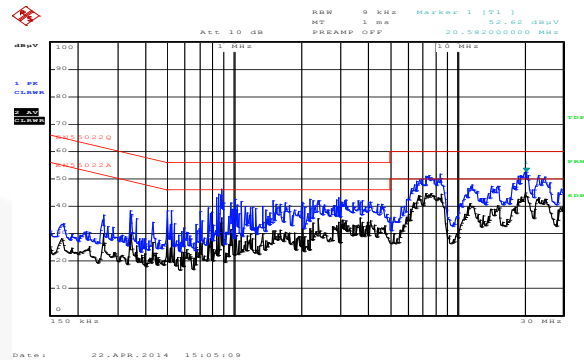

Figure 57. Neutral: 230 V_{AC} / 50 Hz & 9 V_O

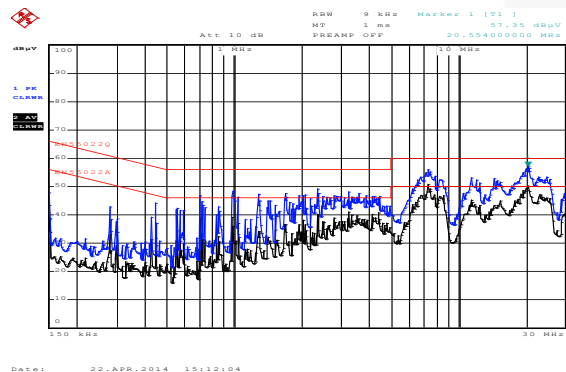

Figure 58. Line: 115 V_{AC} / 60 Hz & 12 V_O

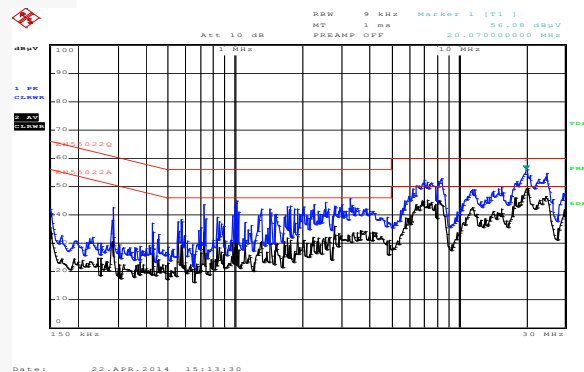

Figure 59. Neutral: 115 V_{AC} / 60 Hz & 12 V_O

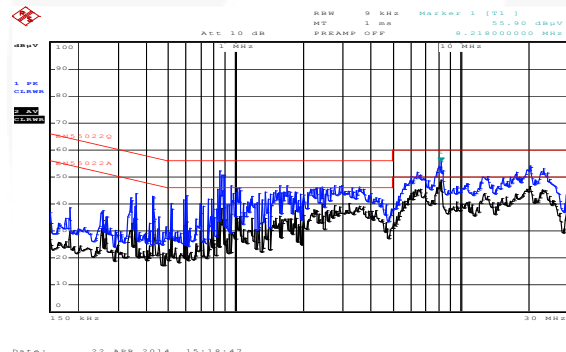

Figure 60. Line: 230 V_{AC} / 50 Hz & 12 V_O

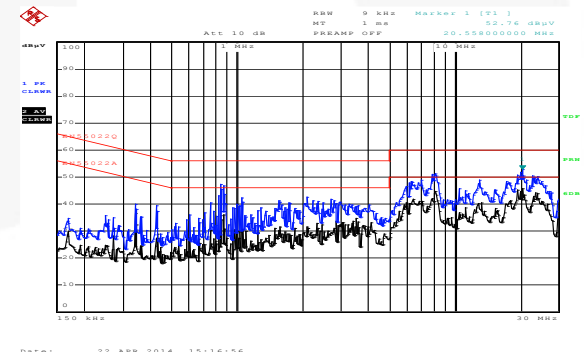

Figure 61. Neutral: 230 V_{AC} / 50 Hz & 12 V_O

9.16. Qualcomm QC2.0 Compatible Test Result

Test Condition

- Mode change function test with Qualcomm protocol.
- 90V_{AC}, minimum load.

Table 19. QC2.0 DP/DN Section Table

	DP	DN	Output Voltage
BC1.2	0.6 V	0.6 V	5 V
Mode 1	0.6 V	0 V	5 V
Mode 2	3.3 V	0.6 V	9 V
Mode 3	0.6V	0.6V	12V

Waveforms:

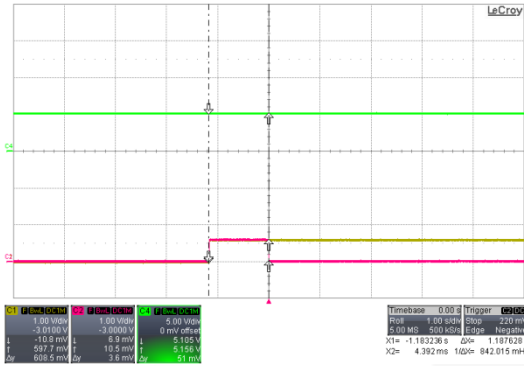

**Figure 62. CH1[DP], CH2[DN], CH4[V_O]
BC1.2 Process**

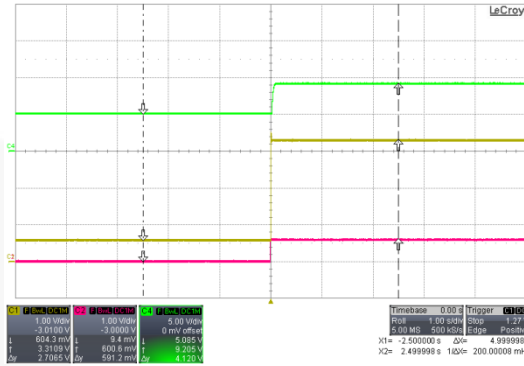

**Figure 63. CH1[DP], CH2[DN], CH4[V_O]
Mode Change from 5 V to 9 V**

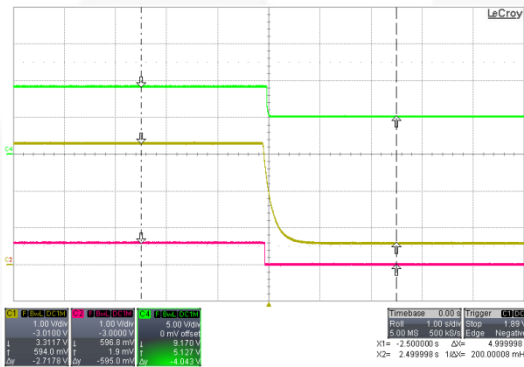

**Figure 64. CH1[DP], CH2[DN], CH4[V_O]
Mode Change from 9 V to 5 V**



**Figure 65. CH1[DP], CH2[DN], CH4[V_O]
Mode Change from 5 V to 12 V**

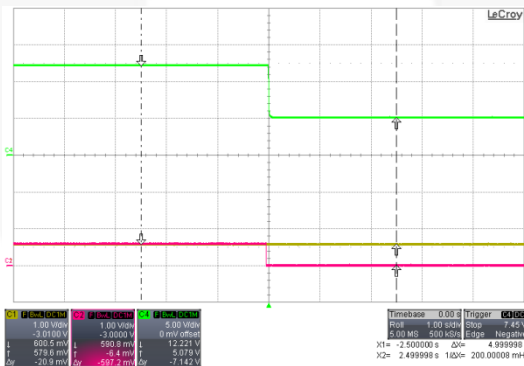

**Figure 66. CH1[DP], CH2[DN], CH4[V_O]
Mode Change from 12 V to 5 V**

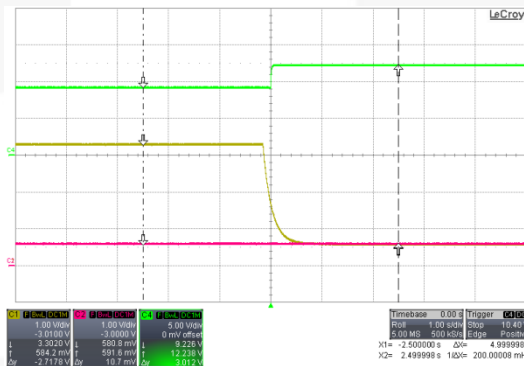

**Figure 67. CH1[DP], CH2[DN], CH4[V_O]
Mode Change from 9 V to 12 V**

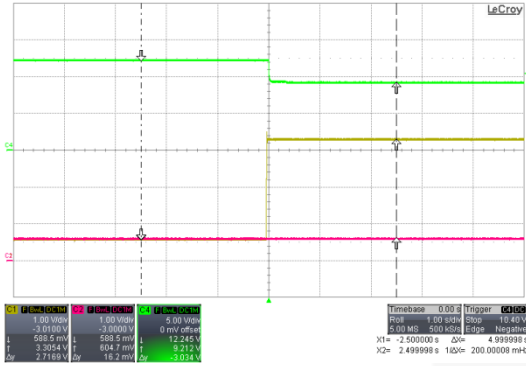

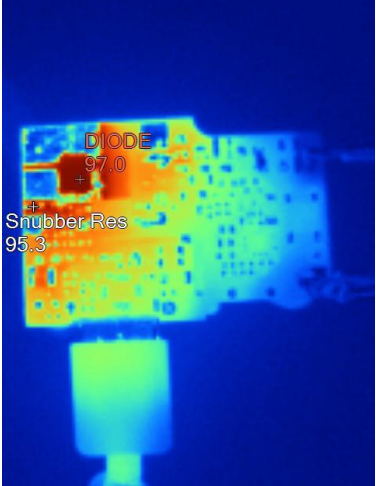
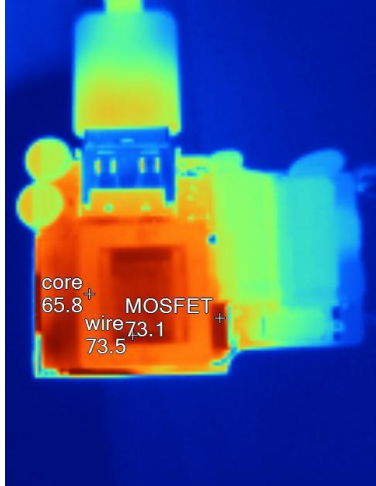
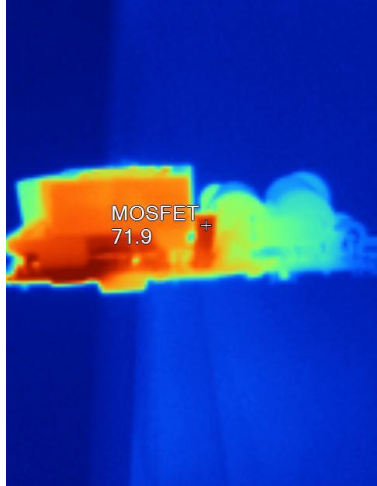

Figure 68. CH1[DP], CH2[DN], CH4[V_o]
Mode Change from 12 V to 9 V





9.17. Component Temperature

Test Condition:

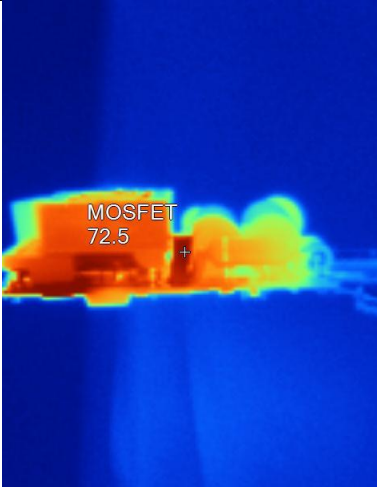
Burn in 60 min. and measure component temperature. 5 V/2 A, 9 V/1.67 A and 12 V/1.25 A at 115 V_{AC}/230 V_{AC}, Ambient: 24°C.

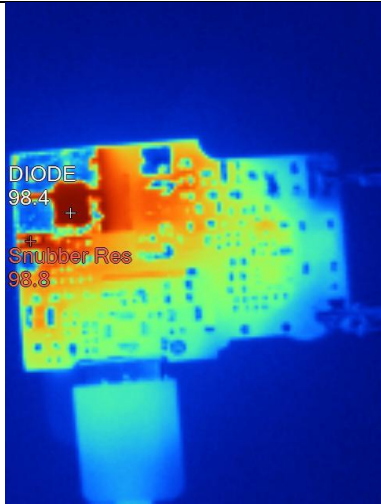
5 V/2 A	MOSFET	Output Diode	Secondary Side Snubber	Transformer Wire	Transformer Core
115 V _{AC}	76.1°C	93.8°C	93.3°C	69°C	63.7°C

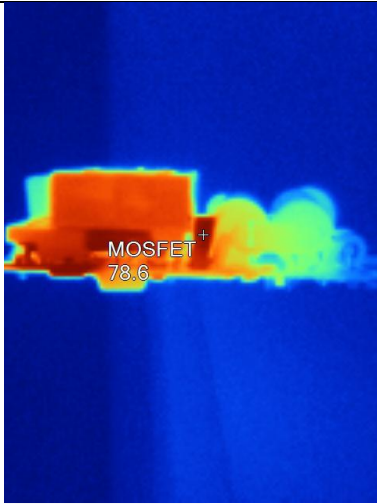
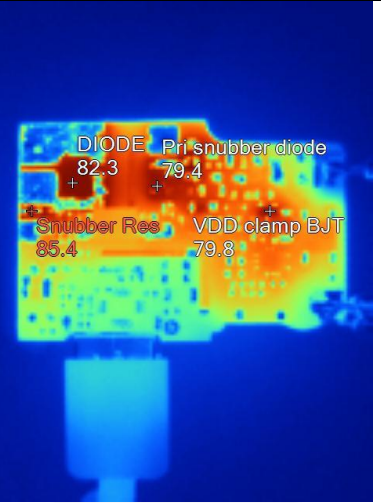
					
5 V/2 A	MOSFET	Output Diode	Secondary Side Snubber	Transformer Wire	Transformer Core
230V_{AC}	73.1°C	97°C	95.3°C	73.5°C	65.8°C
					
9 V/1.67 A	MOSFET	Output Diode	Secondary Side Snubber	Transformer Wire	Transformer Core
115V_{AC}	73.5°C	89.2°C	84.9°C	72.3°C	64.6°C

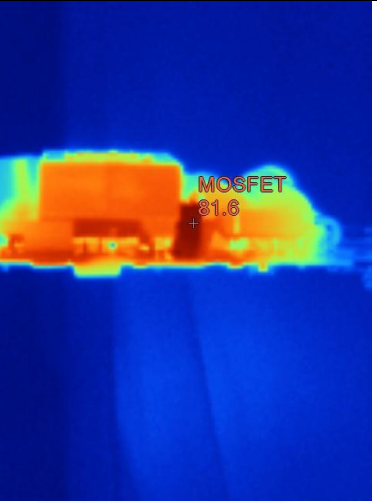
							
9 V/1.67 A	MOSFET	Output Diode	Secondary Side Snubber	Transformer Wire	Transformer Core		
230V _{AC}	80.1°C	98.4°C	98.8°C	79.4°C	71.2°C		
							
12 V/1.25 A	MOSFET	Output Diode	Secondary Side Snubber	Transformer Wire	Transformer Core	Primary Snubber Diode	VDD BJT
115 V _{AC}	82°C	82.3°C	85.4°C	72.1°C	64.4°C	79.4°C	79.8°C

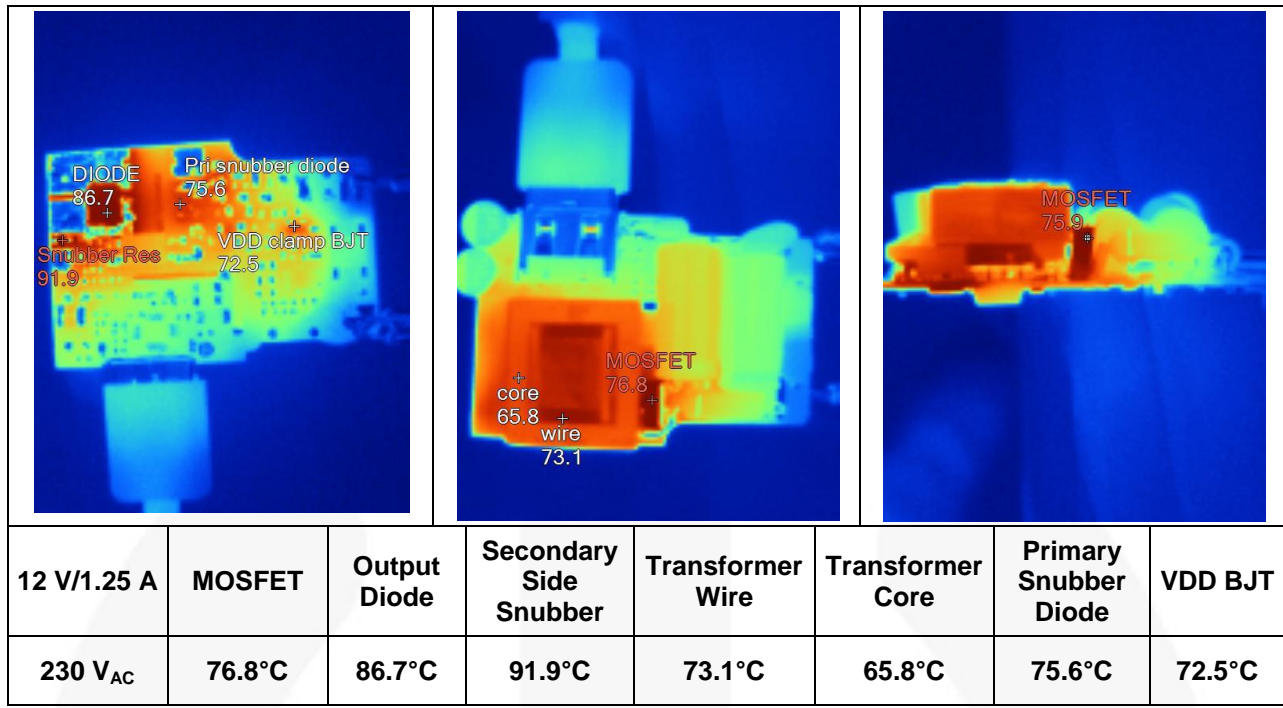



10. Appendix

10.1. Test for 1.5 A Output Current (Fixed Output Current)

Test Condition:

QP resistance (R36) is shorted and QN resistance (R34) is left open to program for 1.5 A constant output current condition in 5 V and 9 V mode. Only in 12 V mode, the maximum current is 1.1 A.

Table 20. Different Current Mode with QP QN Section

	QP	QN	Max. Current Level
Variable CC	0	0	5 V / 2 A, 9 V / 1.67 A, 12 V / 1.25 A
Fixed CC at 1.5 A	0	1	5 V / 1.5 A, 9 V / 1.5 A, 12 V / 1.1 A

Table 21. Efficiency Measurement at Fixed Output Current Setting

V _O = 5 V							
Input Voltage	10%	25%	50%	75%	100%	Avg.	Specification
90 V _{AC} / 60 Hz	82.40%	84.32%	84.35%	84.97%	83.66%	84.33%	CoC Tier2: 115 V _{AC} /230 V _{AC} Average >76.88% 10% >67.65%
115 V _{AC} / 60 Hz	82.43%	84.43%	84.19%	83.56%	84.46%	84.16%	
230 V _{AC} / 50 Hz	80.00%	82.22%	82.46%	83.45%	84.19%	83.08%	
264 V _{AC} / 50 Hz	79.17%	81.28%	81.73%	82.65%	83.39%	82.26%	
V _O = 9 V							
Input Voltage	10%	25%	50%	75%	100%	Avg.	Specification
90 V _{AC} / 60 Hz	80.73%	82.57%	85.82%	86.07%	85.70%	85.04%	CoC Tier2: 115 V _{AC} /230 V _{AC} Average >83.93% 10% >73.59%
115 V _{AC} / 60 Hz	81.79%	83.97%	86.36%	87.37%	86.37%	86.02%	
230 V _{AC} / 50 Hz	80.43%	83.19%	85.80%	87.00%	87.13%	85.78%	
264 V _{AC} / 50 Hz	79.65%	82.53%	85.06%	86.42%	86.54%	85.14%	
V _O = 12 V							
Input Voltage	10%	25%	50%	75%	100%	Avg.	Specification
90 V _{AC} / 60 Hz	77.67%	81.35%	85.73%	87.01%	86.80%	85.22%	CoC Tier2: 115 V _{AC} /230 V _{AC} Average >83.8% 10% >73.47%
115 V _{AC} / 60 Hz	79.77%	83.98%	85.74%	86.40%	87.96%	86.02%	
230 V _{AC} / 50 Hz	77.99%	82.61%	85.71%	87.64%	87.98%	85.99%	
264 V _{AC} / 50 Hz	77.40%	81.97%	85.04%	87.20%	87.43%	85.41%	

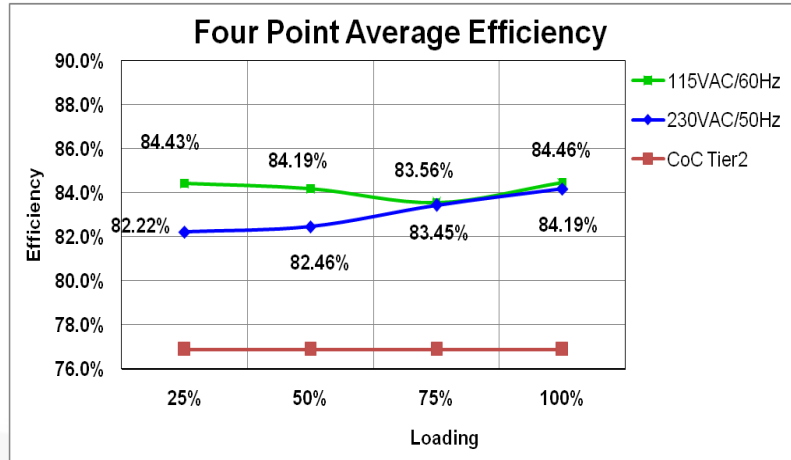

Figure 69. Efficiency at 5 V/1.5 A (Fixed Output Current Setting)

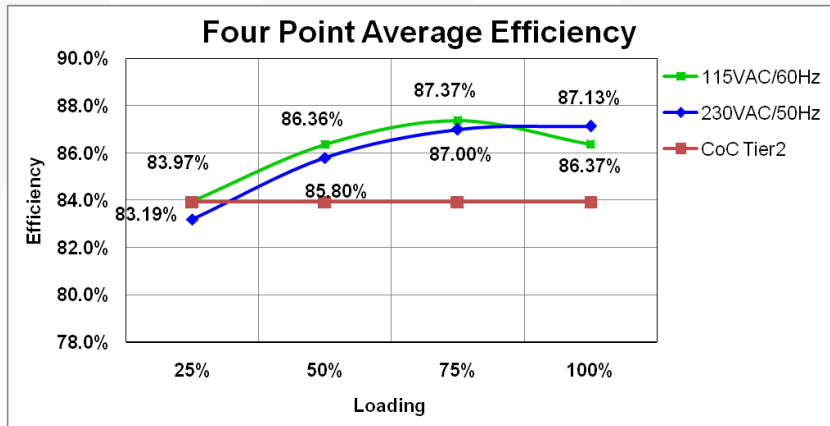

Figure 70. Efficiency at 9 V/1.5 A (Fixed Output Current Setting)

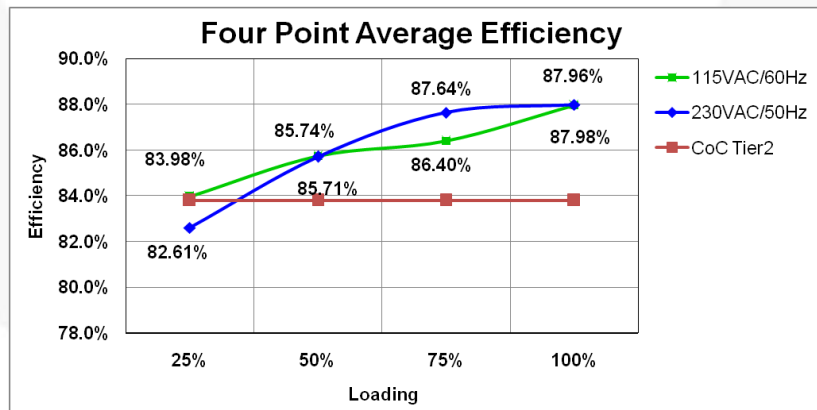

Figure 71. Efficiency at 12 V/1.1 A (Fixed Output Current Setting)



11. Revision History

Rev.	Date	Description
1.0	July 2014	Initial Release

WARNING AND DISCLAIMER

Replace components on the Evaluation Board only with those parts shown on the parts list (or Bill of Materials) in the Users' Guide. Contact an authorized Fairchild representative with any questions.

This board is intended to be used by certified professionals, in a lab environment, following proper safety procedures. Use at your own risk. The Evaluation board (or kit) is for demonstration purposes only and neither the Board nor this User's Guide constitute a sales contract or create any kind of warranty, whether express or implied, as to the applications or products involved. Fairchild warrants that its products meet Fairchild's published specifications, but does not guarantee that its products work in any specific application. Fairchild reserves the right to make changes without notice to any products described herein to improve reliability, function, or design. Either the applicable sales contract signed by Fairchild and Buyer or, if no contract exists, Fairchild's standard Terms and Conditions on the back of Fairchild invoices, govern the terms of sale of the products described herein.

DISCLAIMER

FAIRCHILD SEMICONDUCTOR RESERVES THE RIGHT TO MAKE CHANGES WITHOUT FURTHER NOTICE TO ANY PRODUCTS HEREIN TO IMPROVE RELIABILITY, FUNCTION, OR DESIGN. FAIRCHILD DOES NOT ASSUME ANY LIABILITY ARISING OUT OF THE APPLICATION OR USE OF ANY PRODUCT OR CIRCUIT DESCRIBED HEREIN; NEITHER DOES IT CONVEY ANY LICENSE UNDER ITS PATENT RIGHTS, NOR THE RIGHTS OF OTHERS.

LIFE SUPPORT POLICY

FAIRCHILD'S PRODUCTS ARE NOT AUTHORIZED FOR USE AS CRITICAL COMPONENTS IN LIFE SUPPORT DEVICES OR SYSTEMS WITHOUT THE EXPRESS WRITTEN APPROVAL OF THE PRESIDENT OF FAIRCHILD SEMICONDUCTOR CORPORATION.

As used herein:

1. Life support devices or systems are devices or systems which, (a) are intended for surgical implant into the body, or (b) support or sustain life, or (c) whose failure to perform when properly used in accordance with instructions for use provided in the labeling, can be reasonably expected to result in significant injury to the user.
2. A critical component is any component of a life support device or system whose failure to perform can be reasonably expected to cause the failure of the life support device or system, or to affect its safety or effectiveness.

ANTI-COUNTERFEITING POLICY

Fairchild Semiconductor Corporation's Anti-Counterfeiting Policy. Fairchild's Anti-Counterfeiting Policy is also stated on our external website, www.fairchildsemi.com, under Sales Support.

Counterfeiting of semiconductor parts is a growing problem in the industry. All manufacturers of semiconductor products are experiencing counterfeiting of their parts. Customers who inadvertently purchase counterfeit parts experience many problems such as loss of brand reputation, substandard performance, failed applications, and increased cost of production and manufacturing delays. Fairchild is taking strong measures to protect ourselves and our customers from the proliferation of counterfeit parts. Fairchild strongly encourages customers to purchase Fairchild parts either directly from Fairchild or from Authorized Fairchild Distributors who are listed by country on our web page cited above. Products customers buy either from Fairchild directly or from Authorized Fairchild Distributors are genuine parts, have full traceability, meet Fairchild's quality standards for handling and storage and provide access to Fairchild's full range of up-to-date technical and product information. Fairchild and our Authorized Distributors will stand behind all warranties and will appropriately address any warranty issues that may arise. Fairchild will not provide any warranty coverage or other assistance for parts bought from Unauthorized Sources. Fairchild is committed to combat this global problem and encourage our customers to do their part in stopping this practice by buying direct or from authorized distributors.

EXPORT COMPLIANCE STATEMENT

These commodities, technology, or software were exported from the United States in accordance with the Export Administration Regulations for the ultimate destination listed on the commercial invoice. Diversion contrary to U.S. law is prohibited.

U.S. origin products and products made with U.S. origin technology are subject to U.S. Re-export laws. In the event of re-export, the user will be responsible to ensure the appropriate U.S. export regulations are followed.