

## Phase leg MOSFET Power Module

$V_{DSS} = 200V$   
 $R_{DSon} = 10m\Omega \text{ typ @ } T_j = 25^\circ C$   
 $I_D = 175A \text{ @ } T_c = 25^\circ C$

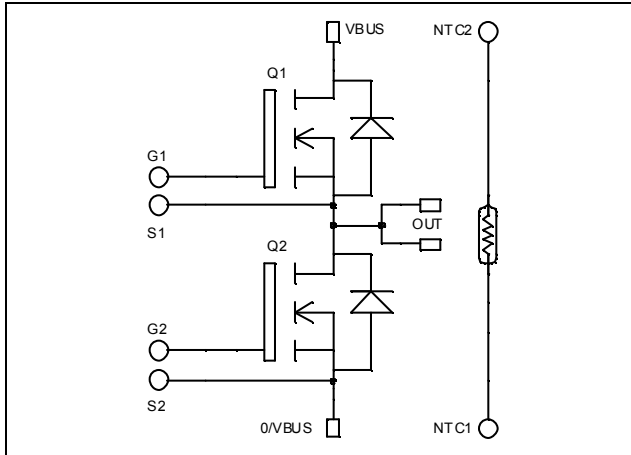

### Application

- Welding converters
- Switched Mode Power Supplies
- Uninterruptible Power Supplies

### Features

- Power MOS 7<sup>®</sup> FREDFETs
  - Low  $R_{DSon}$
  - Low input and Miller capacitance
  - Low gate charge
  - Fast intrinsic reverse diode
  - Avalanche energy rated
  - Very rugged
- Kelvin source for easy drive
- Very low stray inductance
  - Symmetrical design
  - Lead frames for power connections
- Internal thermistor for temperature monitoring
- High level of integration

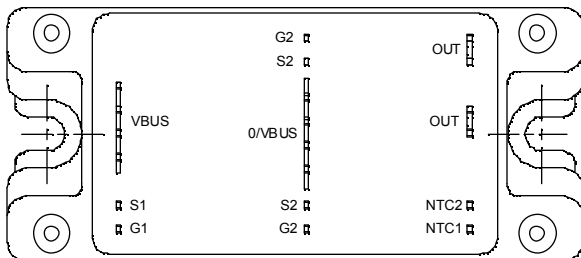

### Benefits

- Outstanding performance at high frequency operation
- Direct mounting to heatsink (isolated package)
- Low junction to case thermal resistance
- Solderable terminals both for power and signal for easy PCB mounting
- Low profile
- RoHS Compliant

### Absolute maximum ratings

Symbol	Parameter	Max ratings	Unit
$V_{DSS}$	Drain - Source Breakdown Voltage	200	V
$I_D$	Continuous Drain Current	$T_c = 25^\circ C$	175
		$T_c = 80^\circ C$	131
$I_{DM}$	Pulsed Drain current	700	A
$V_{GS}$	Gate - Source Voltage	$\pm 30$	V
$R_{DSon}$	Drain - Source ON Resistance	12	$m\Omega$
$P_D$	Maximum Power Dissipation	$T_c = 25^\circ C$	694
$I_{AR}$	Avalanche current (repetitive and non repetitive)	89	A
$E_{AR}$	Repetitive Avalanche Energy	50	mJ
$E_{AS}$	Single Pulse Avalanche Energy	2500	

**CAUTION:** These Devices are sensitive to Electrostatic Discharge. Proper Handling Procedures Should Be Followed. See application note APT0502 on [www.microsemi.com](http://www.microsemi.com)

All ratings @  $T_j = 25^\circ\text{C}$  unless otherwise specified

**Electrical Characteristics**

Symbol	Characteristic	Test Conditions	Min	Typ	Max	Unit
$I_{DSS}$	Zero Gate Voltage Drain Current	$V_{GS} = 0\text{V}, V_{DS} = 200\text{V}$			200	$\mu\text{A}$
		$V_{GS} = 0\text{V}, V_{DS} = 160\text{V}$			1000	
$R_{DS(on)}$	Drain – Source on Resistance	$V_{GS} = 10\text{V}, I_D = 87.5\text{A}$		10	12	$\text{m}\Omega$
$V_{GS(th)}$	Gate Threshold Voltage	$V_{GS} = V_{DS}, I_D = 5\text{mA}$	3		5	V
$I_{GSS}$	Gate – Source Leakage Current	$V_{GS} = \pm 30\text{V}, V_{DS} = 0\text{V}$			$\pm 150$	nA

**Dynamic Characteristics**

Symbol	Characteristic	Test Conditions	Min	Typ	Max	Unit
$C_{iss}$	Input Capacitance	$V_{GS} = 0\text{V}$ $V_{DS} = 25\text{V}$ $f = 1\text{MHz}$		13.7		nF
$C_{oss}$	Output Capacitance			4.36		
$C_{rss}$	Reverse Transfer Capacitance			0.19		
$Q_g$	Total gate Charge	$V_{GS} = 10\text{V}$ $V_{Bus} = 100\text{V}$ $I_D = 150\text{A}$		224		nC
$Q_{gs}$	Gate – Source Charge			86		
$Q_{gd}$	Gate – Drain Charge			94		
$T_{d(on)}$	Turn-on Delay Time	<b>Inductive switching @ <math>125^\circ\text{C}</math></b> $V_{GS} = 15\text{V}$ $V_{Bus} = 133\text{V}$ $I_D = 150\text{A}$ $R_G = 2.5\Omega$		28		ns
$T_r$	Rise Time			56		
$T_{d(off)}$	Turn-off Delay Time			81		
$T_f$	Fall Time			99		
$E_{on}$	Turn-on Switching Energy	<b>Inductive switching @ <math>25^\circ\text{C}</math></b> $V_{GS} = 15\text{V}, V_{Bus} = 133\text{V}$ $I_D = 150\text{A}, R_G = 2.5\Omega$		926		$\mu\text{J}$
$E_{off}$	Turn-off Switching Energy			910		
$E_{on}$	Turn-on Switching Energy	<b>Inductive switching @ <math>125^\circ\text{C}</math></b> $V_{GS} = 15\text{V}, V_{Bus} = 133\text{V}$ $I_D = 150\text{A}, R_G = 2.5\Omega$		1216		$\mu\text{J}$
$E_{off}$	Turn-off Switching Energy			1062		

**Source - Drain diode ratings and characteristics**

Symbol	Characteristic	Test Conditions	Min	Typ	Max	Unit
$I_S$	Continuous Source current (Body diode)		$T_c = 25^\circ\text{C}$		175	A
			$T_c = 80^\circ\text{C}$		131	
$V_{SD}$	Diode Forward Voltage	$V_{GS} = 0\text{V}, I_S = -150\text{A}$			1.3	V
$dv/dt$	Peak Diode Recovery ①				8	V/ns
$t_{rr}$	Reverse Recovery Time	$I_S = -150\text{A}$ $V_R = 133\text{V}$	$T_j = 25^\circ\text{C}$		220	ns
			$T_j = 125^\circ\text{C}$		420	
$Q_{rr}$	Reverse Recovery Charge	$di/dt = 200\text{A}/\mu\text{s}$	$T_j = 25^\circ\text{C}$	2.14		$\mu\text{C}$
			$T_j = 125^\circ\text{C}$	5.8		

 ①  $dv/dt$  numbers reflect the limitations of the circuit rather than the device itself.

$$I_S \leq -150\text{A} \quad di/dt \leq 700\text{A}/\mu\text{s} \quad V_R \leq V_{DSS} \quad T_j \leq 150^\circ\text{C}$$

## Thermal and package characteristics

Symbol	Characteristic	Min	Typ	Max	Unit	
R <sub>thJC</sub>	Junction to Case Thermal Resistance			0.18	°C/W	
V <sub>ISOL</sub>	RMS Isolation Voltage, any terminal to case t=1 min, I <sub>isol</sub> <1mA, 50/60Hz	2500			V	
T <sub>J</sub>	Operating junction temperature range	-40		150	°C	
T <sub>STG</sub>	Storage Temperature Range	-40		125		
T <sub>C</sub>	Operating Case Temperature	-40		100		
Torque	Mounting torque	To Heatsink	M5	2.5	4.7	N.m
Wt	Package Weight				160	g

## Temperature sensor NTC (see application note APT0406 on www.microsemi.com for more information).

Symbol	Characteristic	Min	Typ	Max	Unit
R <sub>25</sub>	Resistance @ 25°C		50		kΩ
B <sub>25/85</sub>	T <sub>25</sub> = 298.15 K		3952		K

$$R_T = \frac{R_{25}}{\exp\left[B_{25/85}\left(\frac{1}{T_{25}} - \frac{1}{T}\right)\right]}$$

T: Thermistor temperature  
 R<sub>T</sub>: Thermistor value at T

## SP4 Package outline (dimensions in mm)

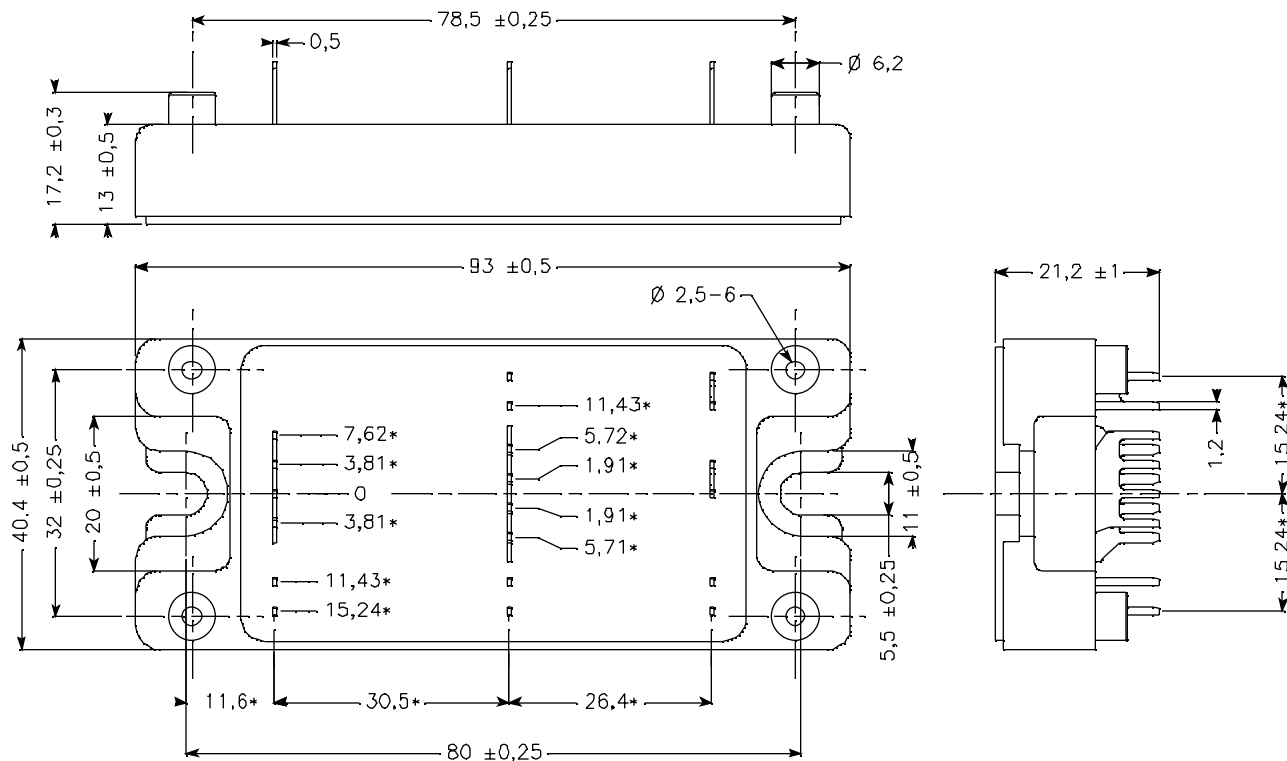

ALL DIMENSIONS MARKED "\*" ARE TOLERANCED AS:  $\boxed{\oplus \ominus 0.1}$

See application note APT0501 - Mounting Instructions for SP4 Power Modules on www.microsemi.com

## Typical Performance Curve

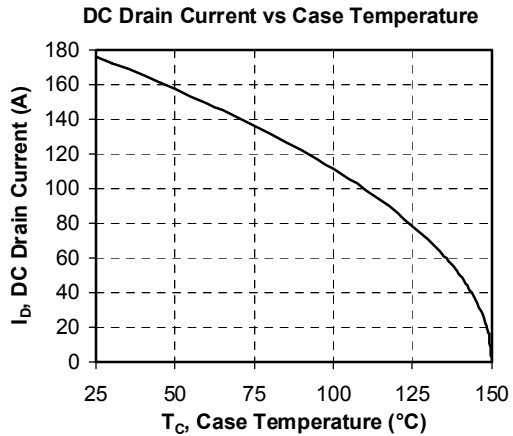
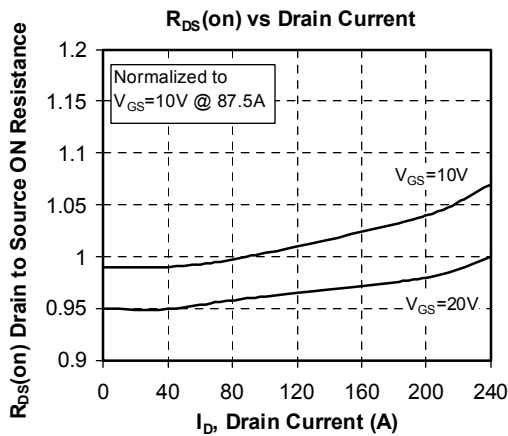
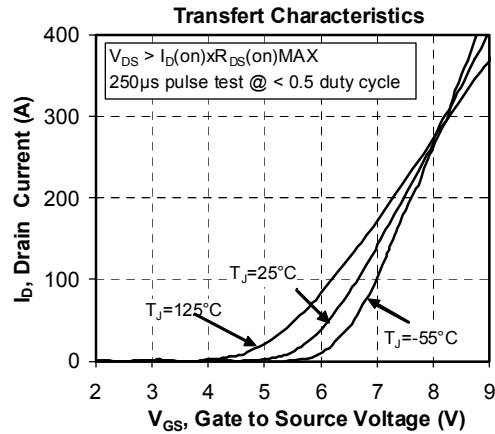
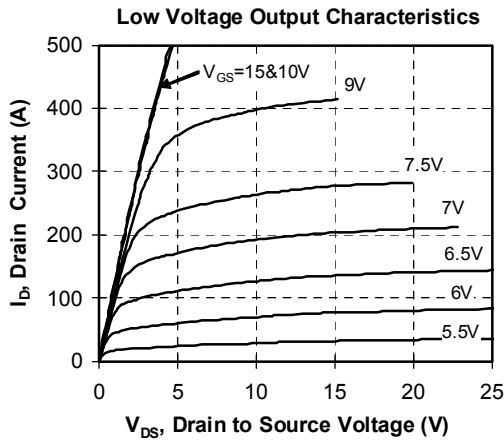
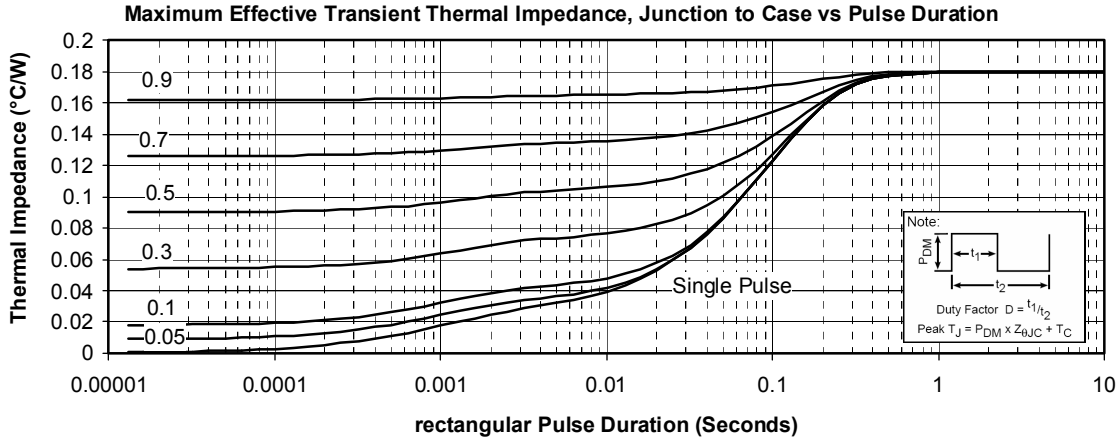

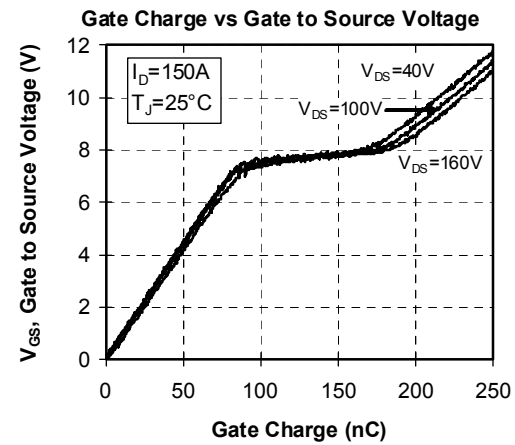
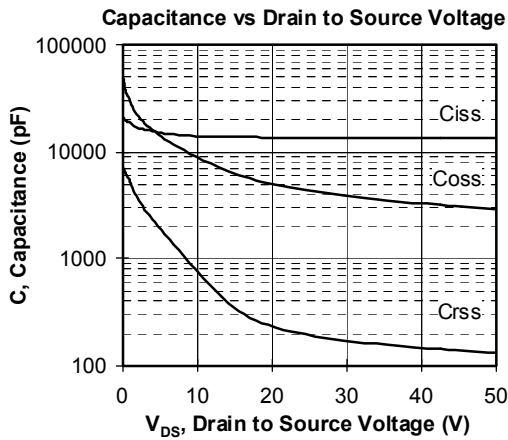
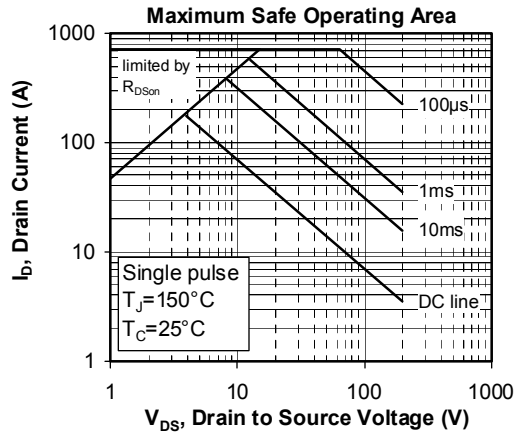
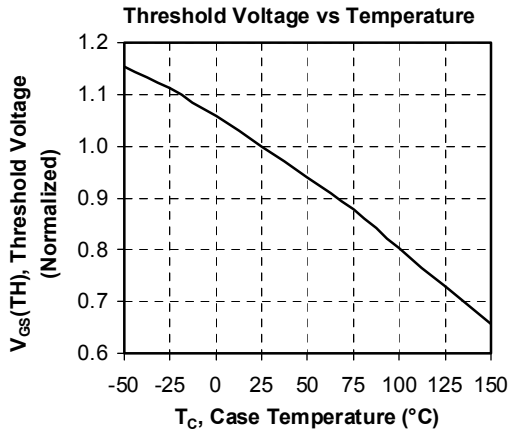
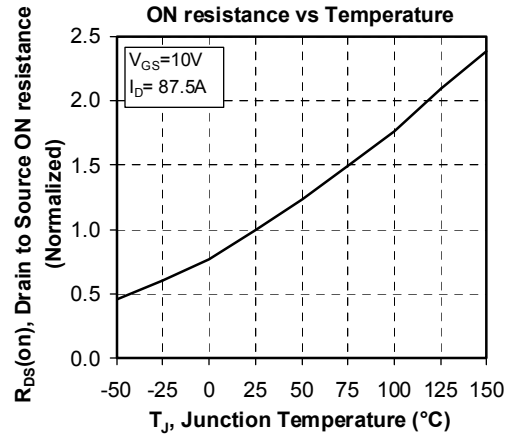
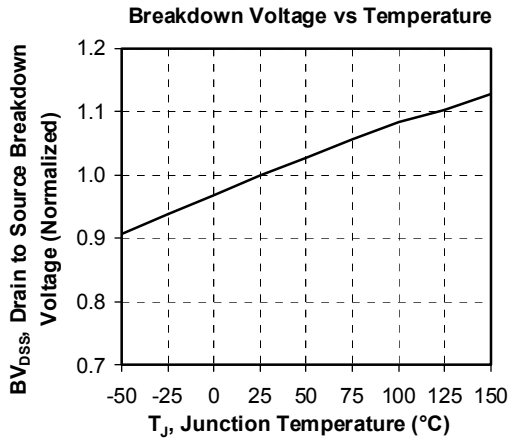

**Delay Times vs Current**

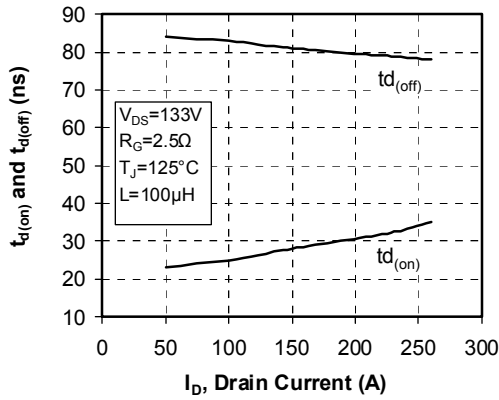

**Rise and Fall times vs Current**

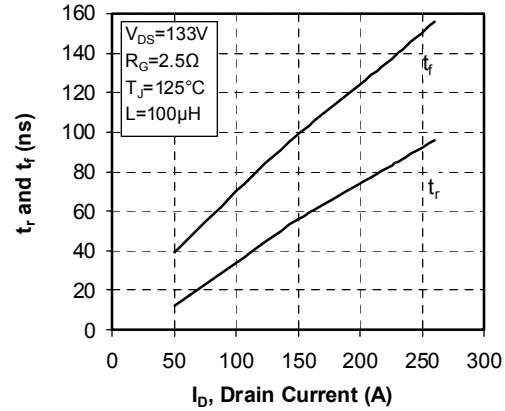

**Switching Energy vs Current**

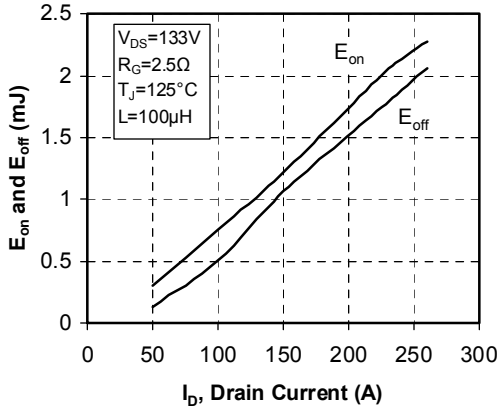

**Switching Energy vs Gate Resistance**

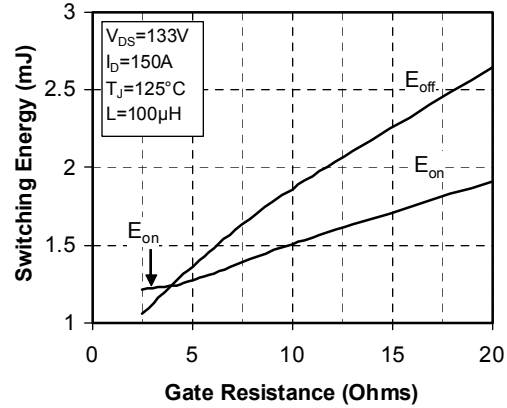

**Operating Frequency vs Drain Current**

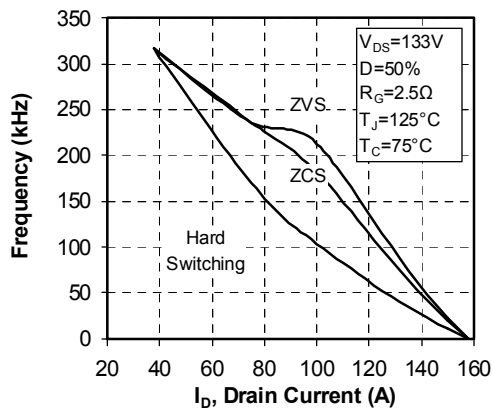

**Source to Drain Diode Forward Voltage**

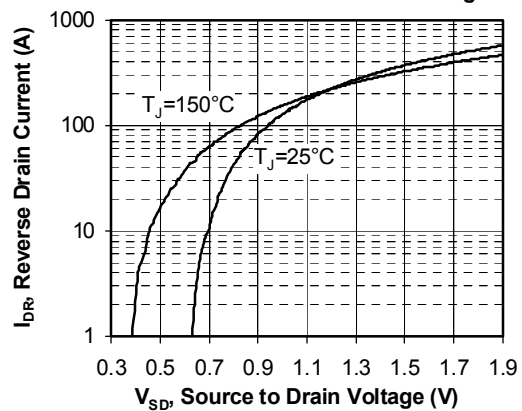

Microsemi reserves the right to change, without notice, the specifications and information contained herein

Microsemi's products are covered by one or more of U.S. patents 4,895,810 5,045,903 5,089,434 5,182,234 5,019,522 5,262,336 6,503,786 5,256,583 4,748,103 5,283,202 5,231,474 5,434,095 5,528,058 and foreign patents. U.S. and Foreign patents pending. All Rights Reserved.