

FAN1589

2.7A, 1.2V Low Dropout Linear Regulator for VRM8.5

Features

- Fast transient response
- Low dropout voltage at up to 2.7A
- Load regulation: 0.05% typical
- Trimmed current limit
- On-chip thermal limiting
- Standard TO-220, TO-263, TO-263 center cut and TO-252 (DPAK) packages

Applications

- A GTL+ bus supply for VRM 8.5
- Low voltage logic supply
- Post regulator for switching supply

Description

The FAN1589 is a low dropout three-terminal regulator with 2.7A output current capability. This device has been optimized for VTT bus termination, where transient response and minimum input voltage are critical. The FAN1589 offers fixed 1.2V with 2.7A current capability for a GTL+ bus VTT termination.

Current limit is trimmed to ensure specified output current and controlled short-circuit current. On-chip thermal limiting provides protection against any combination of overload and ambient temperature that would create excessive junction temperatures.

The FAN1589 is available in the industry-standard TO-220, TO-263, TO-263 center cut and TO-252 (DPAK) power packages.

Typical Application

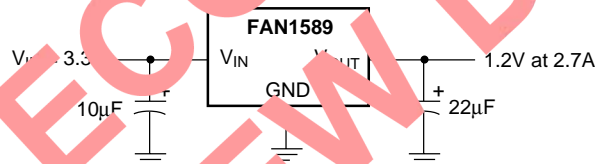

Pin Assignments

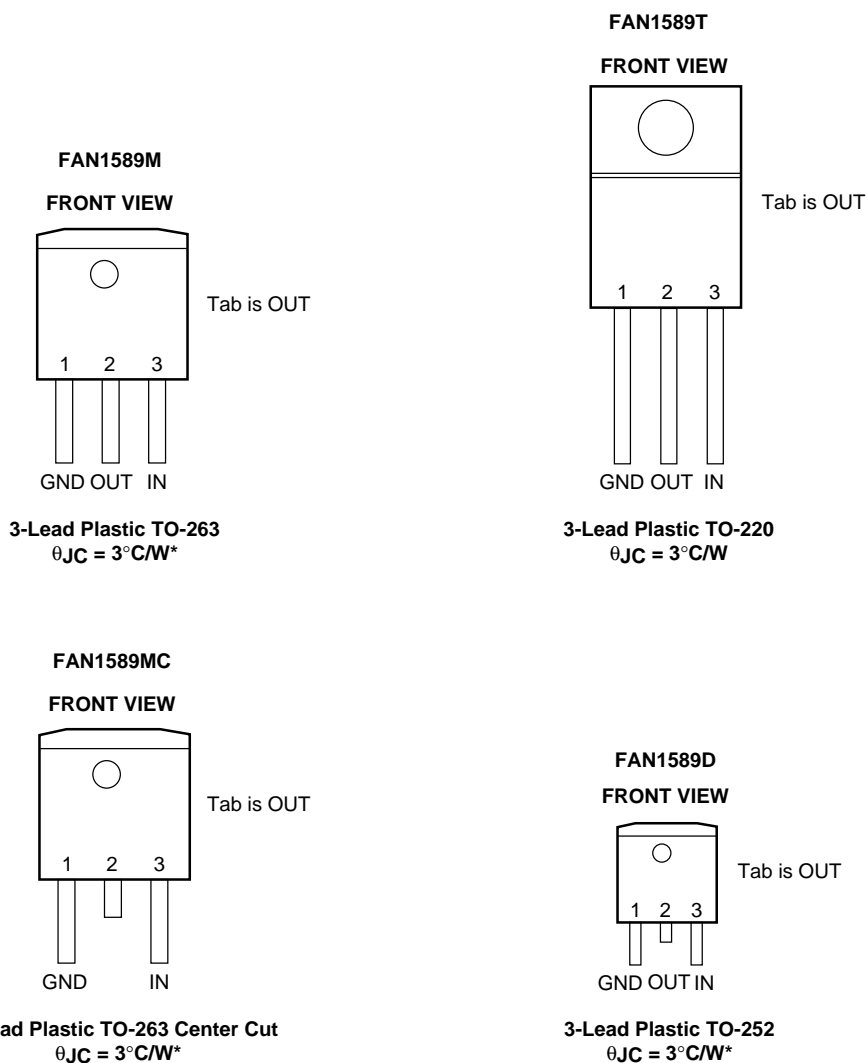

*With package soldered to 0.5 square inch copper area over backside ground plane or internal power plane, Θ_{JA} can vary from 30°C/W to more than 40°C/W . Other mounting techniques can provide a thermal resistance lower than 30°C/W .

Absolute Maximum Ratings

| Parameter | Min. | Max. | Unit |
|---------------------------------------|------|------|------|
| V _{IN} | | 7 | V |
| Operating Junction Temperature Range | 0 | 125 | °C |
| Storage Temperature Range | -65 | 150 | °C |
| Lead Temperature (Soldering, 10 sec.) | | 300 | °C |

Electrical Characteristics

T_j = 25°C unless otherwise specified.

The • denotes specifications which apply over the specified operating temperature range.

| Parameter | Conditions | | Min. | Typ. | Max | Units |
|--|---|---|-------|-------|-------|-------|
| Output Voltage | $3.3V \leq V_{IN} \leq 7V$ $10mA \leq I_{OUT} \leq 2.7A$ | • | 1.176 | 1.200 | 1.224 | V |
| Line Regulation ^{1, 2} | $(V_{OUT} + 1.5V) \leq V_{IN} \leq 7V$, $I_{OUT} = 10mA$ | • | | 0.005 | 0.2 | % |
| Load Regulation ^{1, 2} | $(V_{IN} - V_{OUT}) = 3V$ $10mA \leq I_{OUT} \leq 2.7A$ | • | | 0.15 | 1.5 | % |
| Dropout Voltage | $\Delta V_{REF} = 1\%$, $I_{OUT} = 2.7A$ | • | | 1.150 | 1.300 | V |
| Current Limit | $(V_{IN} - V_{OUT}) = 2V$ | • | 3.1 | 4 | | A |
| Minimum Load Current | $1.5V \leq (V_{IN} - V_{OUT}) \leq 5.75V$ | • | 10 | | | mA |
| Quiescent Current | $V_{IN} = 5V$ | • | | 4 | 13 | mA |
| Ripple Rejection | $f = 120Hz$, $C_{OUT} = 22\mu F$ Tantalum, $(V_{IN} - V_{OUT}) = 3V$, $I_{OUT} = 2.7A$ | | 60 | 72 | | dB |
| Thermal Regulation | $T_A = 25^\circ C$, 30ms pulse | | | 0.004 | 0.02 | %/W |
| Temperature Stability | | • | | 0.5 | | % |
| Long-Term Stability | $T_A = 125^\circ C$, 1000 hrs. | | | 0.03 | 1.0 | % |
| RMS Output Noise (% of V _{OUT}) | $T_A = 25^\circ C$, $10Hz \leq f \leq 10kHz$ | | | 0.003 | | % |
| Thermal Resistance, Junction to Case | TO-220 | | | 3 | | °C/W |
| | TO-263, TO-252 | | | 3 | | °C/W |
| Thermal Shutdown | | | | 150 | | °C |

Notes:

- See thermal regulation specifications for changes in output voltage due to heating effects. Load and line regulation are measured at a constant junction temperature by low duty cycle pulse testing.
- Line and load regulation are guaranteed up to the maximum power dissipation (18W). Power dissipation is determined by input/output differential and the output current. Guaranteed maximum output power will not be available over the full input/output voltage range.

Typical Performance Characteristics

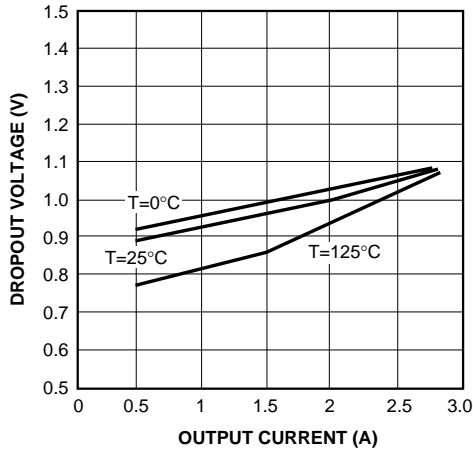

Figure 1. Dropout Voltage vs. Output Current

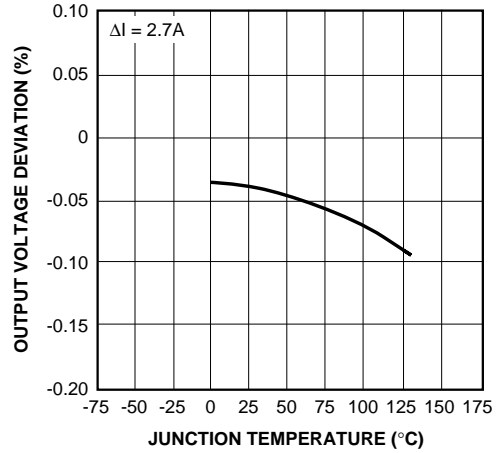

Figure 2. Load Regulation vs. Temperature

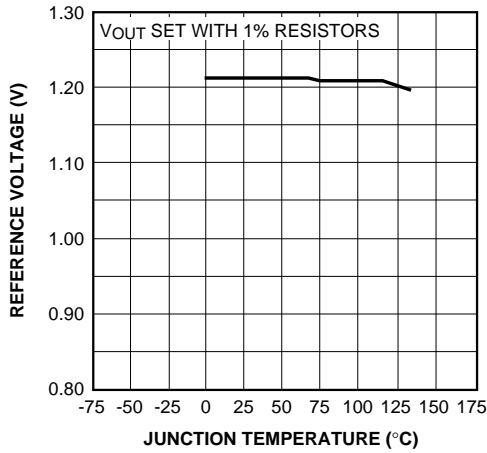

Figure 3. Output Voltage vs. Temperature

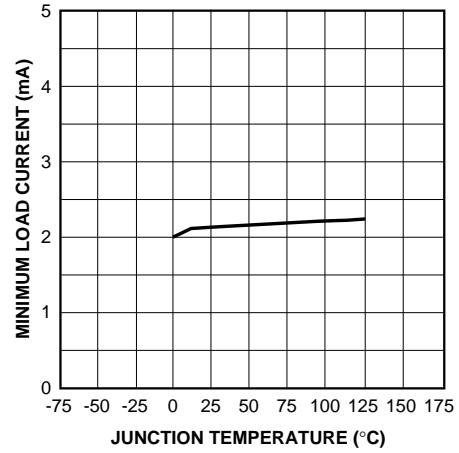

Figure 4. Minimum Load Current vs. Temperature

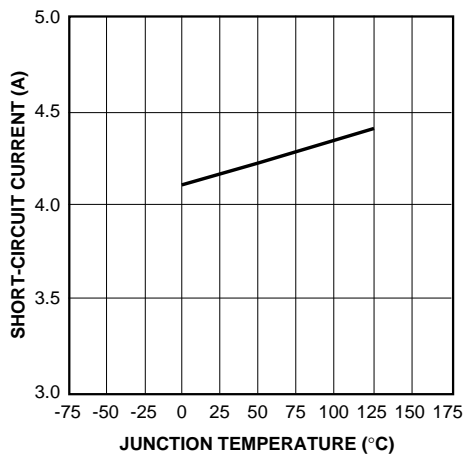

Figure 5. Short-Circuit Current vs. Temperature

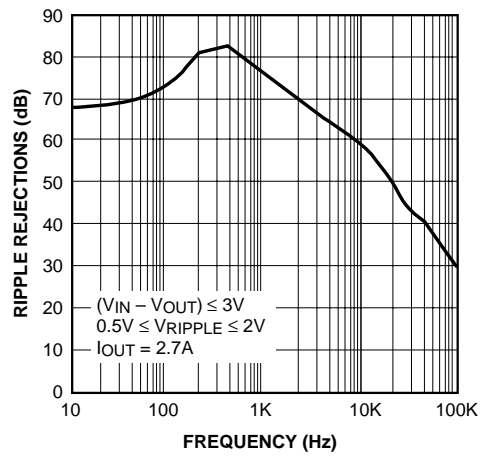

Figure 6. Ripple Rejection vs. Frequency

Typical Performance Characteristics (continued)

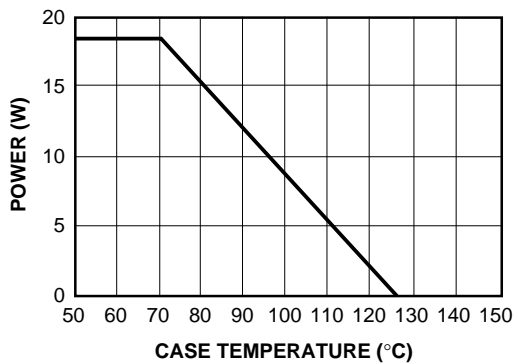

Figure 7. Maximum Power Dissipation

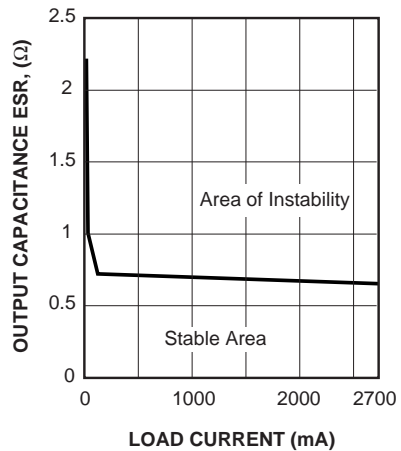

Figure 9. Stability Region

Applications Information

General

The FAN1589 is a three-terminal regulator optimized for a GTL+ VTT termination applications. It is short-circuit protected, and offers thermal shutdown to turn off the regulator when the junction temperature exceeds about 150°C. The FAN1589 provides low dropout voltage and fast transient response. Frequency compensation uses capacitors with low ESR while still maintaining stability. This is critical in addressing the needs of low voltage high speed microprocessor buses like a GTL+.

Stability

The FAN1589 requires an output capacitor as a part of the frequency compensation. It is recommended to use a 22µF solid tantalum or a 100µF aluminum electrolytic on the output to ensure stability. The frequency compensation of these devices optimizes the frequency response with low ESR capacitors. In general, it is suggested to use capacitors with an ESR of <1Ω.

Protection Diodes

In normal operation, the FAN1589 does not require any protection diodes.

A protection diode between the input and output pins is usually not needed. An internal diode between the input and output pins on the FAN1589 can handle microsecond surge currents of 50A to 100A. Even with large value output capacitors it is difficult to obtain those values of surge currents in normal operation. Only with large values of output capacitance, such as 1000µF to 5000µF, and with the input pin instantaneously shorted to ground can damage occur. A crowbar circuit at the input can generate those levels of current; a diode from output to input is then recommended, as shown in Figure 9. Usually, normal power supply cycling or system “hot plugging and unplugging” will not generate current large enough to do any damage.

As with any IC regulator, exceeding the maximum input-to-output voltage differential causes the internal transistors to break down and none of the protection circuitry is then functional.

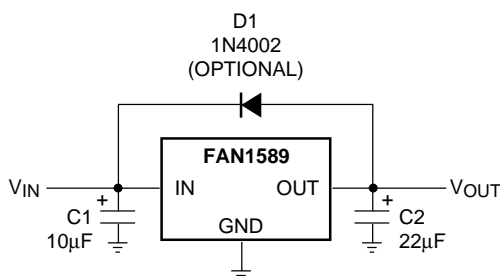

Figure 8. Optional Protection

Load Regulation

It is not possible to provide true remote load sensing because the FAN1589 is a three-terminal device. Load regulation is limited by the resistance of the wire connecting the regulators to the load. Load regulation per the data sheet specification is measured at the bottom of the package.

For fixed voltage devices, negative side sensing is a true Kelvin connection with the ground pin of the device returned to the negative side of the load. This is illustrated in Figure 10.

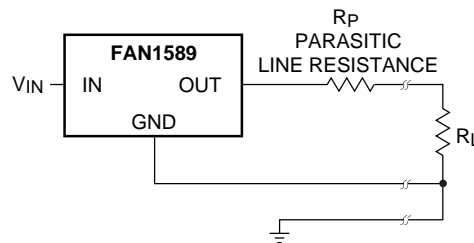

Figure 9. Connection for Best Load Regulation

Thermal Considerations

The FAN1589 protects itself under overload conditions with internal power and thermal limiting circuitry. However, for normal continuous load conditions, do not exceed maximum junction temperature ratings. It is important to consider all sources of thermal resistance from junction-to-ambient. These sources include the junction-to-case resistance, the case-to-heat sink interface resistance, and the heat sink resistance. Thermal resistance specifications have been developed to more accurately reflect device temperature and ensure safe operating temperatures.

For example, look at using an FAN1589 to generate 2.7A @ 1.2V ± 2% from a 3.3V source (3.2V to 3.6V).

Assumptions:

- $V_{IN} = 3.6V$ worst case
- $V_{OUT} = 1.176V$ worst case
- $I_{OUT} = 2.7A$ continuous
- $T_A = 70^\circ C$
- $\theta_{Case-to-Ambient} = 3^\circ C/W$ (assuming both a heatsink and a thermally conductive material)

The power dissipation in this application is:

$$P_D = (V_{IN} - V_{OUT}) * (I_{OUT}) = (3.6 - 1.18) * (2.7) = 6.53W$$

From the specification table:

$$T_J = T_A + (P_D) * (\theta_{Case-to-Ambient} + \theta_{JC}) \\ = 70 + (6.53) * (3 + 3) = 109^\circ C$$

The junction temperature is below the maximum rating.

Junction-to-case thermal resistance is specified from the IC junction to the bottom of the case directly below the die. This is the lowest resistance path for heat flow. Proper mounting ensures the best thermal flow from this area of the package to the heat sink. Use of a thermally conductive material at the case-to-heat sink interface is recommended. Use a thermally conductive spacer if the case of the device must be electrically isolated and include its contribution to the total thermal resistance. The case of the FAN1589 is directly connected to the output of the device.

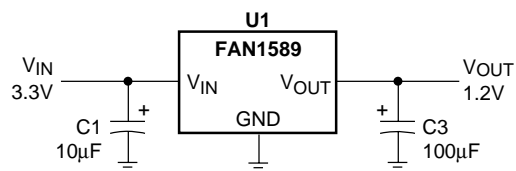

Figure 10. Application Circuit (FAN1589)

Table 1. Bill of Materials for Application Circuit for the FAN1589

| Item | Quantity | Manufacturer | Part Number | Description |
|------|----------|--------------|-------------|---------------------|
| C1 | 1 | Xicon | L10V10 | 10µF, 10V Aluminum |
| C3 | 1 | Xicon | L10V100 | 100µF, 10V Aluminum |
| U1 | 1 | Fairchild | FAN1589T | 2.7A Regulator |

Mechanical Dimensions

3-Lead TO-263 Package

| Symbol | Inches | | Millimeters | | Notes |
|----------|----------|------|-------------|-------|-------|
| | Min. | Max. | Min. | Max. | |
| A | .160 | .190 | 4.06 | 4.83 | |
| b | .020 | .036 | 0.51 | 0.91 | |
| b2 | .049 | .051 | 1.25 | 1.30 | |
| c2 | .045 | .055 | 1.14 | 1.40 | |
| D | .340 | .380 | 8.64 | 9.65 | |
| E | .380 | .405 | 9.65 | 10.29 | |
| e | .100 BSC | | 2.54 BSC | | |
| L | .575 | .625 | 14.61 | 15.88 | |
| L1 | .090 | .110 | 2.29 | 2.79 | |
| L2 | — | .055 | — | 1.40 | |
| R | .017 | .019 | 0.43 | 0.78 | |
| α | 0° | 8° | 0° | 8° | |

Notes:

1. Dimensions are exclusive of mold flash and metal burrs.
2. Standoff-height is measured from lead tip with ref. to Datum -B-.
3. Foot length is measured with ref. to Datum -A- with lead surface (at inner R).
4. Dimension exclusive of dambar protrusion or intrusion.
5. Formed leads to be planar with respect to one another at seating place -C-.

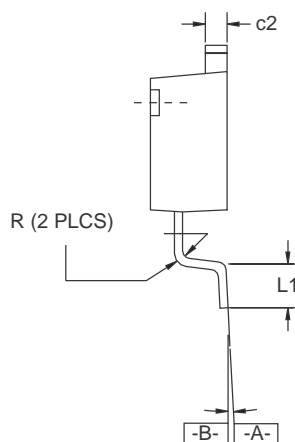
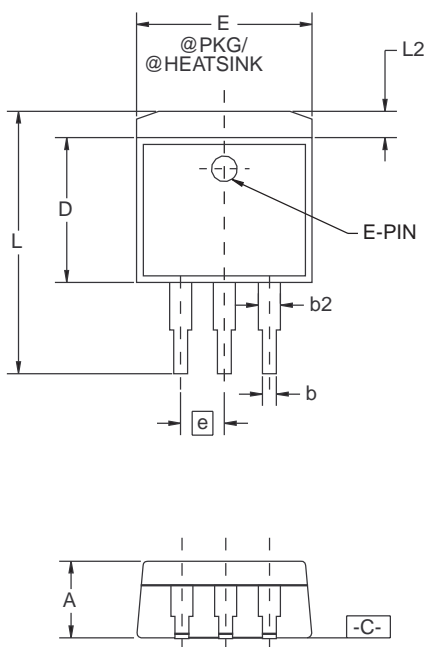

Mechanical Dimensions (continued)

3-Lead TO-263 Center Cut Package

| Symbol | Inches | | Millimeters | | Notes |
|----------|----------|------|-------------|-------|-------|
| | Min. | Max. | Min. | Max. | |
| A | .160 | .190 | 4.06 | 4.83 | |
| b | .020 | .036 | 0.51 | 0.91 | |
| b2 | .049 | .051 | 1.25 | 1.30 | |
| c2 | .045 | .055 | 1.14 | 1.40 | |
| D | .340 | .380 | 8.64 | 9.65 | |
| E | .380 | .405 | 9.65 | 10.29 | |
| e | .100 BSC | | 2.54 BSC | | |
| L | .575 | .625 | 14.61 | 15.88 | |
| L1 | .090 | .110 | 2.29 | 2.79 | |
| L2 | — | .055 | — | 1.40 | |
| L3 | .050 | .070 | 1.27 | 1.78 | |
| R | .017 | .019 | 0.43 | 0.78 | |
| α | 0° | 8° | 0° | 8° | |

Notes:

1. Dimensions are exclusive of mold flash and metal burrs.
2. Standoff-height is measured from lead tip with ref. to Datum -B-.
3. Foot length is measured with ref. to Datum -A- with lead surface (at inner R).
4. Dimension exclusive of dambar protrusion or intrusion.
5. Formed leads to be planar with respect to one another at seating place -C-.

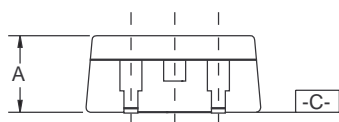
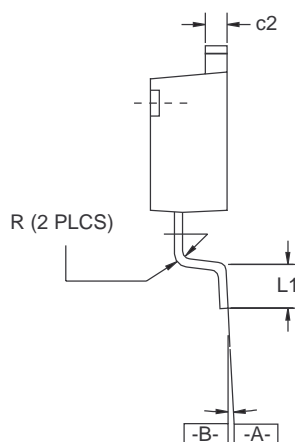
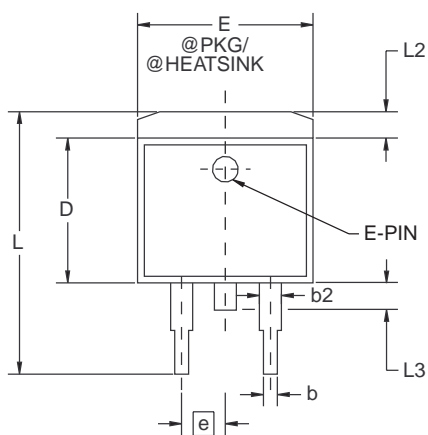

Mechanical Dimensions (continued)

3-Lead TO-220 Package

| Symbol | Inches | | Millimeters | | Notes |
|--------|----------|------|-------------|-------|-------|
| | Min. | Max. | Min. | Max. | |
| A | .140 | .190 | 3.56 | 4.83 | |
| b | .015 | .040 | .38 | 1.02 | |
| b1 | .045 | .070 | 1.14 | 1.78 | |
| c1 | .014 | .022 | .36 | .56 | |
| øP | .139 | .161 | 3.53 | 4.09 | |
| D | .560 | .650 | 14.22 | 16.51 | |
| E | .380 | .420 | 9.65 | 10.67 | |
| e | .090 | .110 | 2.29 | 2.79 | |
| e1 | .190 | .210 | 4.83 | 5.33 | |
| e3 | .045 | — | 1.14 | — | |
| F | .020 | .055 | .51 | 1.40 | |
| H1 | .230 | .270 | 5.94 | 6.87 | |
| J1 | .080 | .115 | 2.04 | 2.92 | |
| L | .500 | .580 | 12.70 | 14.73 | |
| L1 | .250 BSC | | 6.35 BSC | | |
| Q | .100 | .135 | 2.54 | 3.43 | |
| α | 3° | 7° | 3° | 7° | |

Notes:

1. Dimension c1 apply for lead finish.

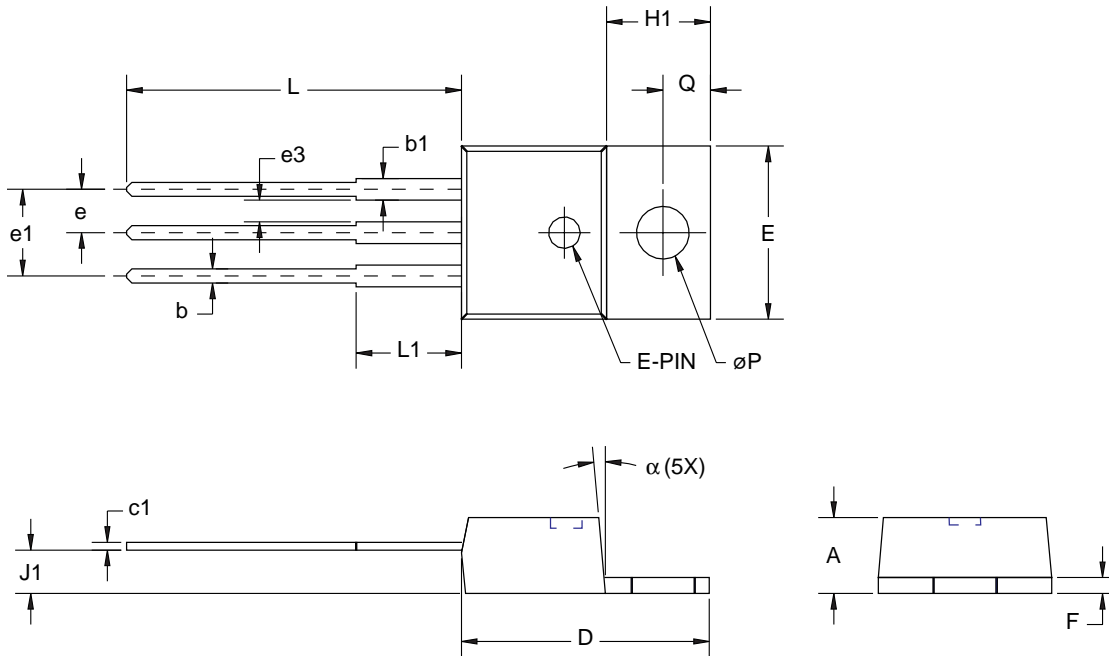

Mechanical Dimensions (continued)

3-Lead TO-252 Package

| Symbol | Inches | | Millimeters | | Notes |
|--------|----------|------|-------------|-------|-------|
| | Min. | Max. | Min. | Max. | |
| A | .086 | .094 | 2.19 | 2.39 | |
| b | .025 | .035 | 0.64 | 0.89 | |
| b2 | .030 | .045 | 0.76 | 1.14 | |
| b3 | .205 | .215 | 5.21 | 5.46 | 4 |
| c | .018 | .024 | 0.46 | 0.61 | |
| c2 | .018 | .023 | 0.46 | 0.58 | |
| D | .210 | .245 | 5.33 | 6.22 | 1 |
| E | .250 | .265 | 6.35 | 6.73 | 1 |
| e | .090 BSC | | 2.29 BSC | | |
| H | .370 | .410 | 9.40 | 10.41 | |
| L | .055 | .070 | 1.40 | 1.78 | 3 |
| L1 | .108 REF | | 2.74 REF | | |
| L3 | .035 | .080 | 0.89 | 2.03 | 4 |
| L4 | .025 | .040 | 0.64 | 1.02 | |

Notes:

1. Dimensions are exclusive of mold flash, metal burrs or interlead protrusion.
2. Stand off-height is measured from lead tip with ref. to Datum -B-.
3. Foot length is measured with ref. to Datum -A- with lead surface.
4. Thermal pad contour optional within dimension b3 and L3.
5. Formed leads to be planar with respect to one another at seating place -C-.
6. Dimensions and tolerances per ASME Y14.5M-1994.

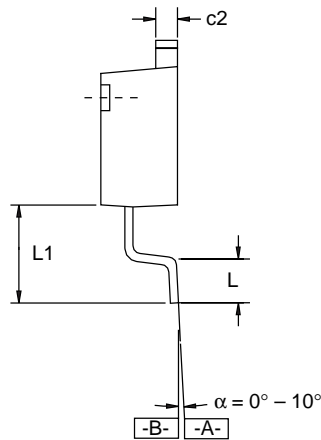
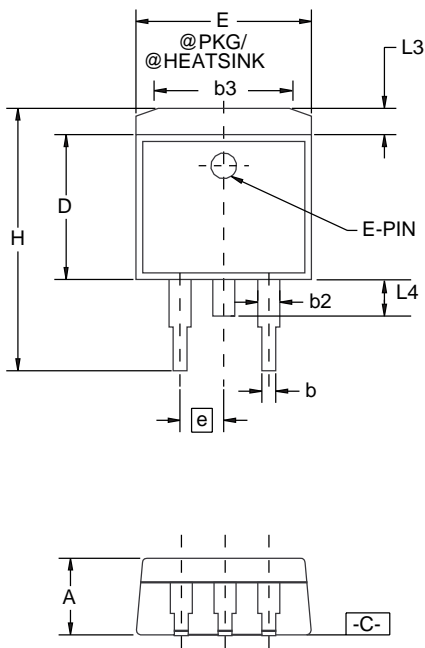

Ordering Information

| Product Number | Package |
|----------------|------------------------------------|
| FAN1589MX | TO-263 in tape and reel |
| FAN1589MCX | TO-263 center cut in tape and reel |
| FAN1589T | TO-220 |
| FAN1589DX | TO-252 in tape and reel |

DISCLAIMER

FAIRCHILD SEMICONDUCTOR RESERVES THE RIGHT TO MAKE CHANGES WITHOUT FURTHER NOTICE TO ANY PRODUCTS HEREIN TO IMPROVE RELIABILITY, FUNCTION OR DESIGN. FAIRCHILD DOES NOT ASSUME ANY LIABILITY ARISING OUT OF THE APPLICATION OR USE OF ANY PRODUCT OR CIRCUIT DESCRIBED HEREIN; NEITHER DOES IT CONVEY ANY LICENSE UNDER ITS PATENT RIGHTS, NOR THE RIGHTS OF OTHERS.

LIFE SUPPORT POLICY

FAIRCHILD'S PRODUCTS ARE NOT AUTHORIZED FOR USE AS CRITICAL COMPONENTS IN LIFE SUPPORT DEVICES OR SYSTEMS WITHOUT THE EXPRESS WRITTEN APPROVAL OF THE PRESIDENT OF FAIRCHILD SEMICONDUCTOR CORPORATION. As used herein:

1. Life support devices or systems are devices or systems which, (a) are intended for surgical implant into the body, or (b) support or sustain life, and (c) whose failure to perform when properly used in accordance with instructions for use provided in the labeling, can be reasonably expected to result in a significant injury of the user.
2. A critical component in any component of a life support device or system whose failure to perform can be reasonably expected to cause the failure of the life support device or system, or to affect its safety or effectiveness.