

QUICK START GUIDE FOR DEMONSTRATION CIRCUIT 617

ISOLATED SYNCHRONOUS FORWARD CONVERTER - QUARTER BRICK

LT3781 and LTC1698

DESCRIPTION

Demonstration circuit 617 is an isolated synchronous forward converter featuring the LT3781 and LTC1698 controllers. DC617 is designed to be a board level replacement for "quarter-brick" DC/DC converters. The design can provide an isolated 2.5V at 20A from a 48V (36V to 72V) input. Isolation voltage is 1500VDC. The circuit features low input capacitance, over temperature protection, soft start with input undervoltage

and overvoltage lockout. Cycling short circuit protection minimizes thermal stress. The output overvoltage circuit provides protection for the load should a fault occur on the sense lines. The standard footprint allows for immediate on board evaluation by plugging directly into the modules' socket.

Design files for this circuit board are available. Call the LTC factory.

Table 1. Performance Summary. $T_A = 25^\circ\text{C}$, $V_{IN} = 48\text{V}$, full load, ON/OFF and TRIM pins open, +SENSE shorted to +VOUT, -SENSE shorted to -VOUT, unless otherwise specified.

PARAMETER	CONDITION	MIN	TYP	MAX	UNITS
Input Voltage Range		36	48	72	V
Maximum Input Current	$V_{IN} = 36\text{V}$, Full Load		1.6		A
Inrush Transient	$V_{IN} = 72\text{V}$			0.2	A^2s
Reflected Ripple Current			100		$\text{mA}_{\text{P-P}}$
Output Voltage		2.40	2.50	2.60	V
Output Regulation	Line			0.1	%
	Load			0.2	%
Output Current				20	A
Output Current Limit			24		A
Output Short Circuit	Cycling, Auto-restart		1000		ms
Output Ripple and Noise	RMS		15		mV_{RMS}
	Peak-to-peak (5Hz to 20MHZ)		40	60	$\text{mV}_{\text{P-P}}$
Efficiency			86.1		%
Dynamic Response	Peak Deviation		50	100	mV
Load Step 50% to 100%	Settling Time (to within 10mV of set point)		100	200	μs
Output Voltage Trim	$V_{\text{TRIM}} = 3.3\text{V}$	4	5	6	%
	$V_{\text{TRIM}} = 0\text{V}$	-6	-5	-4	%
Output Overvoltage			2.70		V
On/Off Control	Logic Low Voltage– Off	0		0.6	V
	Logic High Voltage– On	1.0			V
	Logic Low Current – Off		0.2		mA
	Quiescent Current – Off		1.4		mA
	Start-up Inhibit Period		7.5		ms
	Turn on Time		10	15	ms

QUICK START GUIDE FOR DEMONSTRATION CIRCUIT 617

ISOLATED SYNCHRONOUS FORWARD CONVERTER - QUARTER BRICK

PARAMETER	CONDITION	MIN	TYP	MAX	UNITS
Thermal Shutdown	At RT1		100		°C
Isolation Voltage				1500	VDC
Isolation Resistance		10			MΩ
Isolation Capacitance			2200		pF

OPERATING PRINCIPLES

CIRCUIT OVERVIEW

This two-transistor forward converter operates at a nominal switching frequency of 240kHz. Pulse width modulation control is done by U3, the LT3781 synchronous forward controller. Galvanic isolation is met with transformers T1, T2 and optocoupler ISO1. C10 is used as a local bypass to reduce common mode currents.

The main switching power path is comprised of C2 and C3 feeding the primary winding of T1, with Q1 and Q3 as the primary switches. MOSFETs Q4, 5, 6, and 7 are the secondary synchronous rectifiers. L3 and C4-7 are the secondary output filter. Power is transferred during the on cycle of Q1 and Q3. D1 and D2 recover energy stored in the leakage inductance of T1 during the off cycle. The input inductor L1 was chosen for its relatively low parallel impedance, which helps to damp the input filter. C1 bypasses the input terminals. For large values of input inductance, an external 12μF 100V low ESR aluminum electrolytic capacitor will damp the input filter and provide adequate stability. See Linear Technology's application note AN19 for a discussion on input filter stability analysis.

When the primary switches turn off, the transformer voltage reverses, with D1 and D2 conducting to reset the transformer during normal operation. A startup or transient to no load can cause the pulse width modulation to narrow, with insufficient energy to force the reset diodes into conduction. When this occurs, the charge on C20 gets depleted and the top gate drive shuts off. This will result in the converter cycling on and off. To overcome this, Q10 provides a return path to refresh the top gate boost capacitor C20.

Secondary side bias supply power is provided by T3, a small inexpensive gate drive transformer. This steps up the voltage across the output inductor L3 producing about 7V. Feedback control of the output voltage and synchronous drive is done using U2, the LTC1698. The LTC1698 synchronizes with the LT3781 via T2, a small pulse transformer. The LTC1698 includes an error amplifier and optocoupler drive buffer, eliminating the output feed-forward path associated with '431 type references. U2 also provides output overvoltage protection. The margin pin allows the output voltage to be adjusted $\pm 5\%$.

During an output short circuit condition, the primary bias supply at Vcc collapses. This results in the converter harmlessly cycling on and off, keeping power dissipation to a minimum. The cycling rate is nominally 1Hz with 48V input. When the short is removed, the converter returns to normal operation.

The demo board uses all surface mount devices and will deliver 15A at room temperature with no airflow. To prevent thermal shutdown, utilize the curve in Figure 11. The thermal shutdown at RT1 is set for 100°C. To run at 20A out with 50°C ambient will require at least 200LFM of airflow. Figure 6 through Figure 10 show other component temperature rise. Building the circuit on a multi-layer system board can provide improved thermal performance. Typical efficiency is shown in Figure 5.

For -48V inputs requiring hot swap capability, the LT4250H negative voltage hot swap controller provides a seamless interface.

OPTIONAL FAST START CIRCUIT

When power is first applied, Vcc must rise to 15V for the LT3781 to turn on. The bias supply turn on

threshold and hysteresis are set internally by U3. R8 and R9 charge the 100 μ F capacitor C25, and are gated by Q9. With 200 Ω resistance, the charge time is 7.5ms at 48V in. The values for R8 and R9 can be adjusted in order to change the turn on delay. Values lower than 100 Ω for each resistor will result in abnormally high peak power, and possible component failure. Once the LT3781 turns on, the 5Vref charges C12 causing Q11 to turn off Q9. Bias supply power is delivered through L2 by a winding on T1. In the event of an output short circuit, the voltage on the transformer bias winding collapses. Restart time is determined by C12 and R15, and is set to approximately 1 second.

The optional fast start circuit can be removed, and a 20k Ω resistor installed for R25. The peak bias supply voltage is self limiting by an internal 18V clamp on the LT3781 Vcc pin. R25 will trickle charge C25, resulting in a turn on delay of approximately 750ms at 48V in.

OPTIONAL DIFFERENTIAL SENSE

The LT1783 operational amplifier U1 provides true differential remote sense. If this feature is not required the circuit can be removed. To maintain voltage regulation, a zero ohm resistor must be installed for R28.

FORWARD CONVERTER DESIGN EQUATIONS

The two-transistor forward converter is a good choice for 48V telecom applications. The maximum duty cycle is limited to 50% with the two-transistor forward. This topology is used quite extensively in many modular designs. Unlike the flyback, energy is not intentionally stored in the power transformer. This allows for a much smaller transformer design.

The forward converter has pulsating current in the input capacitor, and continuous current in the out

put capacitor. Worst case ripple current for the input capacitor occurs at 50% duty cycle. Two 0.82 μ F ceramic capacitors, C2 and C3 are used for the input filter. An aluminum electrolytic type can be substituted as long as it is rated for at least 1.9A RMS. The

basic two-transistor synchronous forward converter diagram is shown in Figure 3. The idealized equations for duty cycle relationships are shown below.

Basic Duty Cycle Equation:

$$V_{OUT} = V_{IN} \cdot DC \cdot \frac{N_S}{N_P}$$

Input Capacitor RMS Current:

$$I_{RMS} = I_{OUT} \cdot \frac{N_S}{N_P} \cdot \sqrt{DC - DC^2}$$

Output Capacitor RMS Current:

$$I_{RMS} = \frac{I_L(pk-pk)}{\sqrt{12}}$$

Inductor Ripple Current:

$$I_L(pk-pk) = \frac{(V_{OUT} + V_D) \cdot (1 - DC) \cdot f_{sw}}{L}$$

Primary RMS Current:

$$I_{RMS} = I_{OUT} \cdot \frac{N_S}{N_P} \cdot \sqrt{DC}$$

Secondary RMS Current:

$$I_{RMS} = I_{OUT} \cdot \sqrt{DC}$$

SAFETY AND ISOLATION

The demo board is designed to meet the requirements of UL 60950, 3rd edition for basic insulation in secondary circuits. The input is considered to be a TNV-2 circuit, and the output is SELV. The optocoupler and bridging capacitor both have agency file numbers. A 3A fast blow type fuse must be placed in series with the ungrounded (hot) input line.

The transformer is designed to meet the basic insulation requirement, with an isolation voltage of 1500VDC. The core is considered to be part of the

QUICK START GUIDE FOR DEMONSTRATION CIRCUIT 617

ISOLATED SYNCHRONOUS FORWARD CONVERTER - QUARTER BRICK

secondary circuit. As currently built, the transformer uses a class A material insulating system.

CONDUCTED EMI

Tests for conducted emissions were performed for the demo board. A small external PI filter using a 12 μ F aluminum electrolytic capacitor, 15 μ H inductor and 10 μ F film capacitor allows the converter to meet the CISPR 22 class B limit. See Figure 12 and Figure 13 for test results. No tests for radiated RFI were performed because the radiation is application specific. Proper grounding and layout technique must be ob-

served to minimize radiation. See Figure 4 for test setup.

RELIABILITY

Reliability prediction for the circuit has been calculated using the Telcordia (formerly Bellcore) SR-332. The black box technique was used. The calculation was made assuming a ground, fixed, controlled environment and quality level II. A 50% electrical stress at 40°C yields an MTBF (mean time between failures) of 1.5 million hours.

QUICK START PROCEDURE

Demonstration circuit 617 is easy to set up to evaluate the performance of the LT3781 and LTC1698. Refer to Figure 1 for proper measurement equipment setup and follow the procedure below:

NOTE: When measuring the input or output voltage ripple, care must be taken to avoid a long ground lead on the oscilloscope probe. Measure the input or output voltage ripple by touching the probe tip directly across the Vin or Vout and GND terminals. See Figure 2 for proper scope probe technique.

1. For normal operation, leave the On/Off pin open. Shorting this pin to $-V_{in}$ will turn off the converter.
2. Connect -Sense to $-V_{out}$ and +Sense to $+V_{out}$. The Trim pin should be left floating.

3. Connect the power supply and meters to the Vin pins.
4. Connect the load and meters to the Vout pins.
5. After all connections are made, turn on the input power and verify the output voltage, regulation, ripple voltage, efficiency and other parameters.

See Figure 5 to Figure 13 for expected performance.

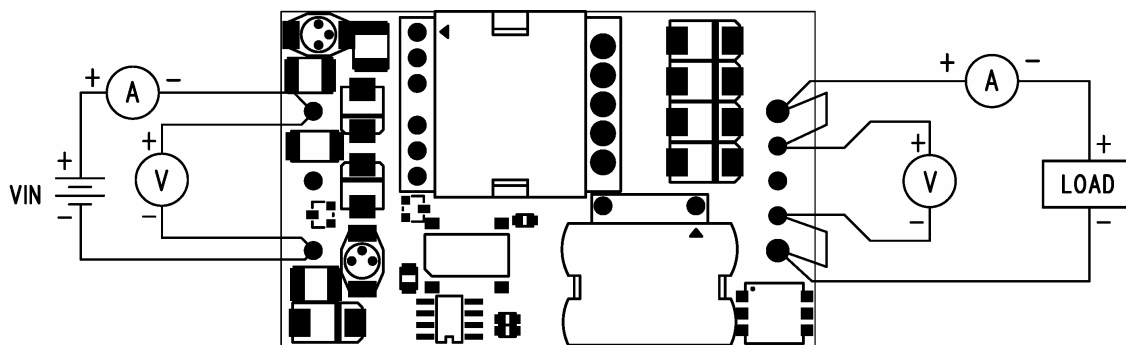

Figure 1. Proper Measurement Equipment Setup

QUICK START GUIDE FOR DEMONSTRATION CIRCUIT 617

ISOLATED SYNCHRONOUS FORWARD CONVERTER - QUARTER BRICK

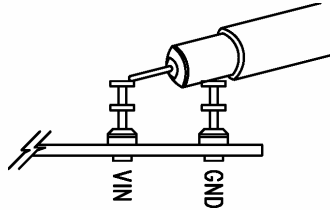

Figure 2. Measuring Input or Output Ripple

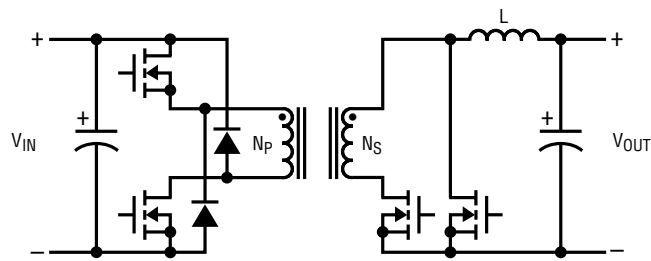

Figure 3. Basic Two-transistor Forward Converter

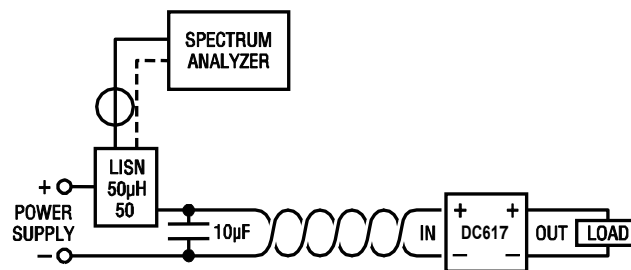

Figure 4. EMI Test Setup

QUICK START GUIDE FOR DEMONSTRATION CIRCUIT 617

ISOLATED SYNCHRONOUS FORWARD CONVERTER - QUARTER BRICK

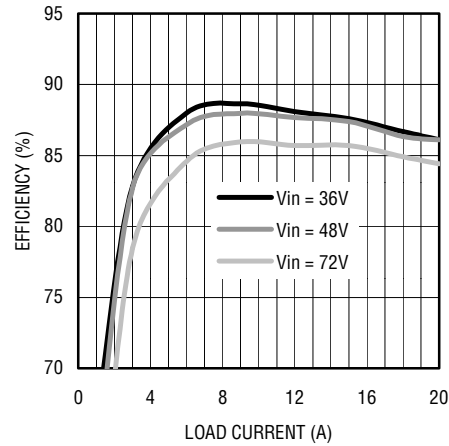

Figure 5. Typical Efficiency

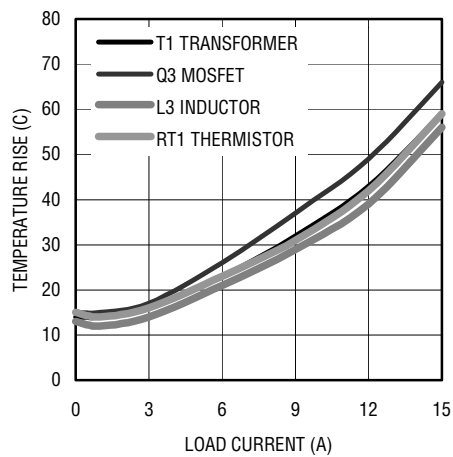

Figure 6. Temperature Rise at $V_{in} = 36V$, No Airflow

QUICK START GUIDE FOR DEMONSTRATION CIRCUIT 617

ISOLATED SYNCHRONOUS FORWARD CONVERTER - QUARTER BRICK

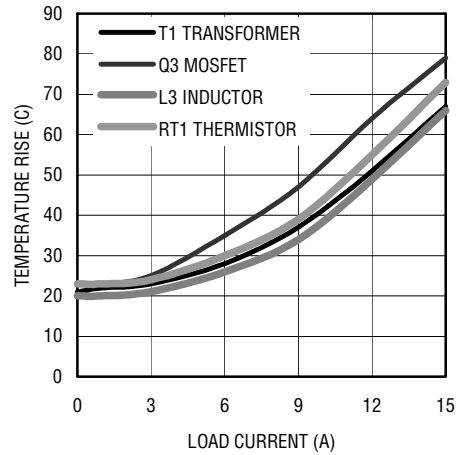

Figure 7. Temperature Rise at $V_{in} = 72V$, No Airflow

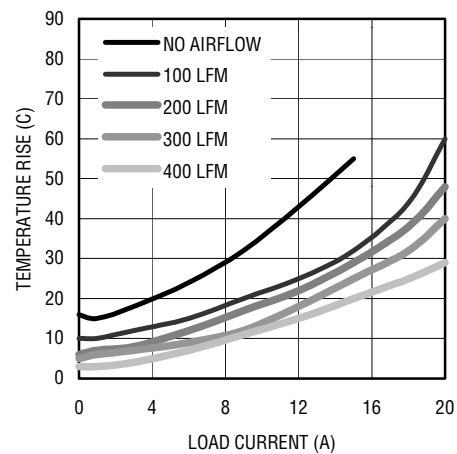

Figure 8. T1 Temperature Rise at $V_{in} = 48V$

QUICK START GUIDE FOR DEMONSTRATION CIRCUIT 617

ISOLATED SYNCHRONOUS FORWARD CONVERTER - QUARTER BRICK

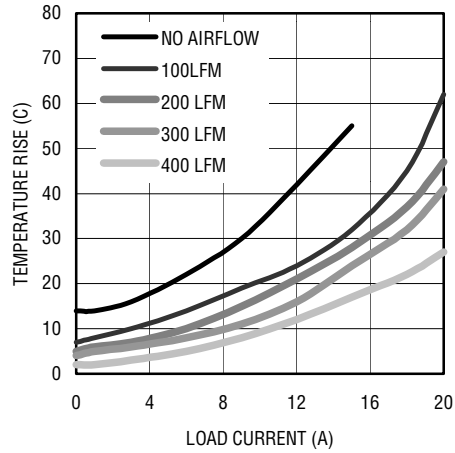

Figure 9. L3 Temperature Rise at $V_{in} = 48V$

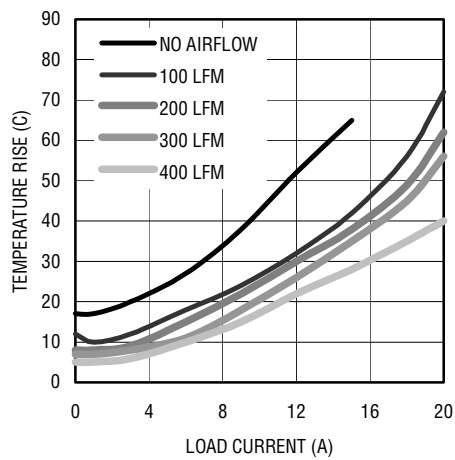

Figure 10. Q3 Temperature Rise at $V_{in} = 48V$ (Hottest PCB Spot)

QUICK START GUIDE FOR DEMONSTRATION CIRCUIT 617

ISOLATED SYNCHRONOUS FORWARD CONVERTER - QUARTER BRICK

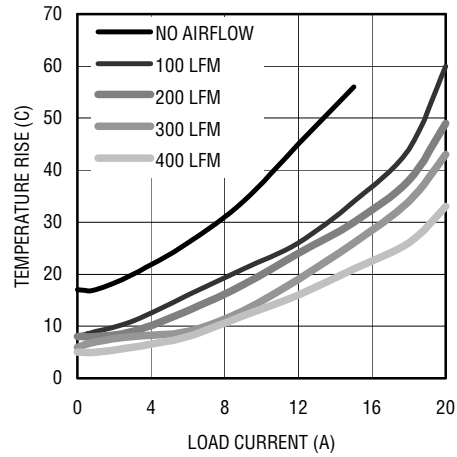

Figure 11. RT1 Temperature Rise at $V_{in} = 48V$

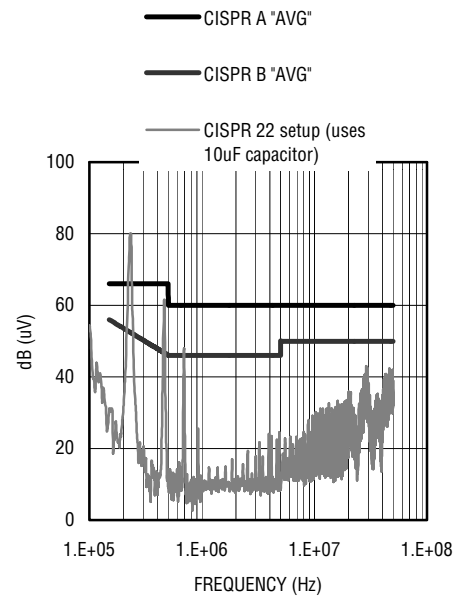

Figure 12. Conducted Emissions at $V_{in} = 48V$

QUICK START GUIDE FOR DEMONSTRATION CIRCUIT 617

ISOLATED SYNCHRONOUS FORWARD CONVERTER - QUARTER BRICK

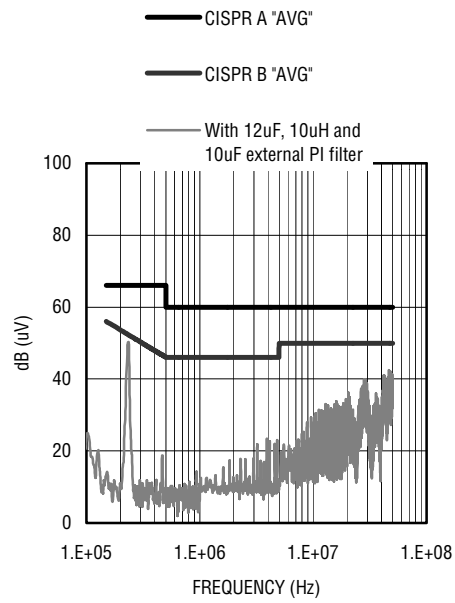
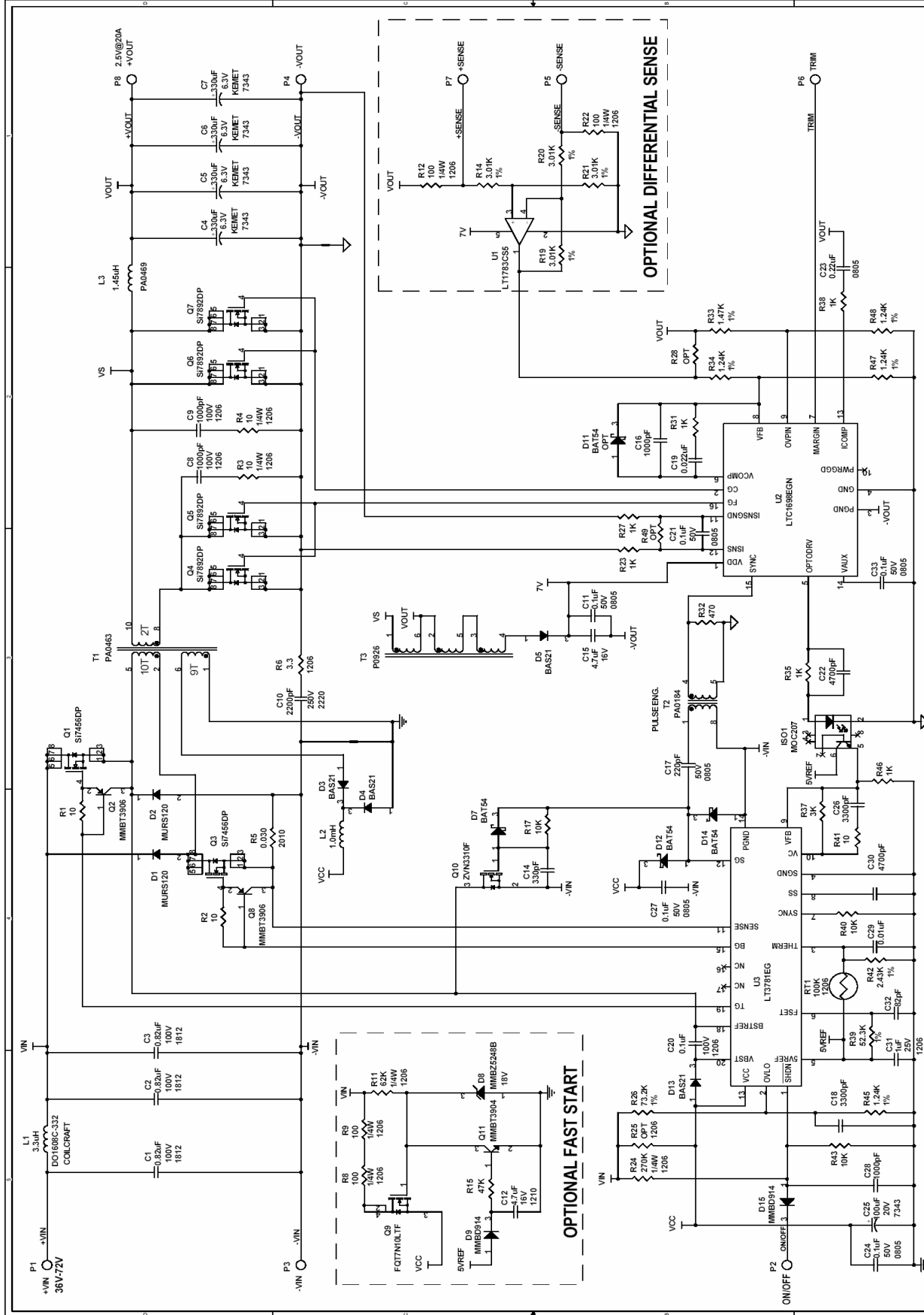

Figure 13. Conducted Emissions at $V_{in} = 48V$ with External PI Filter

QUICK START GUIDE FOR DEMONSTRATION CIRCUIT 617

ISOLATED SYNCHRONOUS FORWARD CONVERTER - QUARTER BRICK



CONTRACT NO.	1530 MCG-4111 BML
APPROVALS	LINEAR TECHNOLOGY
DRAWN	11/04/02
CHECKED	11/04/02
APPROVED	11/04/02
ENGINEER	11/04/02
DESIGNER	11/04/02
TITLE	ISOLATED SYNCHRONOUS FORWARD CONVERTER
DWG NO.	DC617A
SIZE	A
REV	1
DATE	Thursday, October 17, 2002
SHEET	1 OF 1

NOTES: UNLESS OTHERWISE SPECIFIED

- TO DISABLE OPTIONAL FAST START:
REMOVE C12, D8, D9, R8, R9, R11, R15, Q9, Q11; ADD R25 = 20K.
- TO DISABLE OPTIONAL DIFFERENTIAL SENSE:
REMOVE R12, R14, R19-ZZ, U1; ADD R28 = 0 OHM.
- ALL RES. ARE IN OHMS, 0603. ALL CAP. ARE 0603.
ALL DIODES ARE MMBD914BL-T1.
ALL NPNs ARE MMBT3904LT1.
ALL PNP's ARE MMBT3906LT1.

LINEAR TECHNOLOGY	11
-------------------	----