

| NO. | MASSE / DIMENSION |
|-----|-------------------|
| A | 43.1 |
| B | 1 3/16-18UNEF-2A |
| C | 61 |
| D | 24.6 |
| E | 30 |
| F | 9.4 |

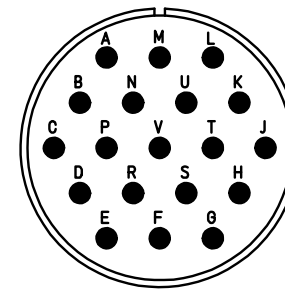
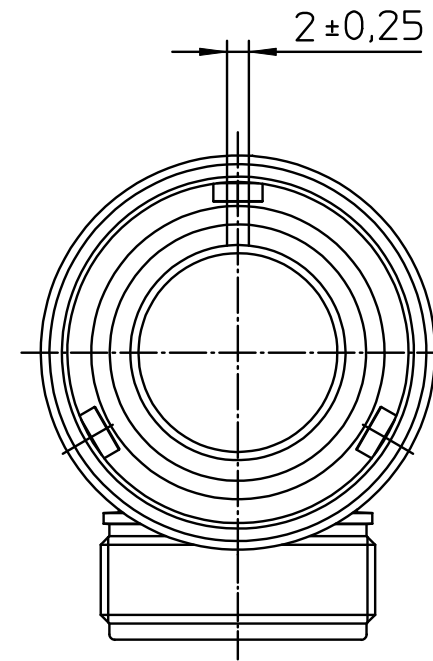
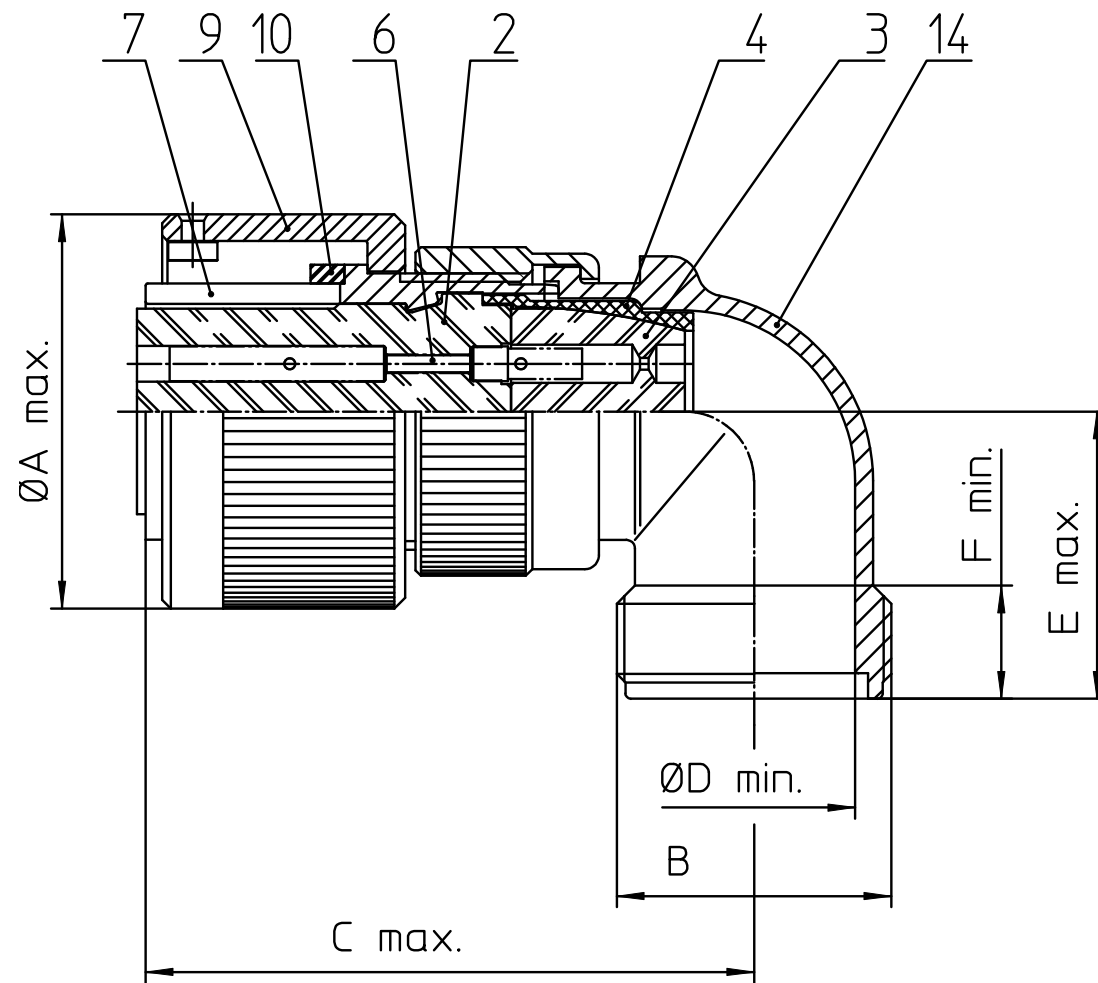

| NO. | BESCHREIBUNG / DESCRIPTION |
|-----|---|
| 2 | ISOLIERKÖRPER BUCHSE / INSULATOR SOCKET |
| 3 | DICHTKÖRPER / GROMMET |
| 4 | ENDRING / ENDRING |
| 6 | KONTAKTBUCHSE / CONTACT SOCKET |
| 7 | ZYLINDERGHÄUSE / BARREL |
| 9 | ÜBERWURFMUTTER / COUPLING NUT |
| 10 | DICHTRING FRONT / FRONT SEALING RING |
| 11 | SCHIRMKRANZ/SHIELDING BRAID |
| 14 | F-ENDGEHÄUSE / F-ENDBELL |

Note: Due to an automatic nomenclature system, numbers generated may not be sequential.
 Specification and Dimensions subject to change
 Drawings illustrate normal insulator positioning

| Material Specification: | |
|-------------------------|---|
| Shell Material: | Aluminium alloy |
| Shell Plating: | Olive drab chromate over cadmium (conductive) |
| Insulator Material: | CR-Elastomere |
| Contact Material: | Copper alloy |
| Contact Plating: | Hard silver |

all dimensions are in mm
 Dimensions without tolerance indications are general tolerances in acc. with DIN7168m

drawing for
 CUSTOMER



description CA3108F22-14S-B-15
 Plug, 90° shielded
 Shielded with endbell for shielded braids & heat shrinkable boots
 AWG Crimp / Socket / Layout: 22-14