

**Pushbutton Switches, Splashproof Boot Seals**

A wide selection of stock boot seals for pushbuttons are available in a variety of styles and thread sizes. ALCOSWITCH seals replace standard mounting hardware to provide environmental seal. Fabricated of Neoprene in black and optional red or gray. Custom colors and thread sizes are also available on special order.



BP10480

**10-48 PUSHBUTTON BOOT SEALS**

Splashproof seal designed for "TINY" pushbutton switches having a 10-48 bushing and .14" long button actuators. The hex nut is molded-in to the Neoprene seal. No O-Ring is required. Custom colors are available on special order.

Part Number					
Tyco Electronics	Alcoswitch	Mount Color	Boot Color	Thread Size	Use with Switch Types
1-1437626-4	BP10480	Black	Black	10-48	TP Series
1-1437626-5	BP10482	Red	Red	10-48	TP Series
1-1437626-6	BP10488	Gray	Gray	10-48	TP Series

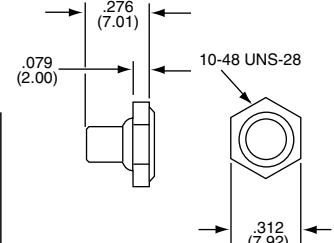

BPA14400



BP14400

**1/4-40 PUSHBUTTON BOOT SEALS**

Splashproof seals for miniature pushbuttons having a 1/4-40 bushing. The two models allow use with buttons that extend up to .17" (BPA) or up to .33" (BP). The hex nut is molded-in and no O-Ring is required.

Part Number					
Tyco Electronics	Alcoswitch	Mount Color	Boot Color	Thread Size	Use with Switch Types
1-1437626-7	BP14400	Black	Black	1/4-40	MSPM, MPA3, MPS and TP Series
1-1437626-8	BP14402	Red	Red	1/4-40	MSPM, MPA3, MPS and TP Series
1-1437626-9	BP14408	Gray	Gray	1/4-40	MSPM, MPA3, MPS and TP Series
2-1437626-7	BPA14400	Black	Black	1/4-40	MSPMBS, MSPMCS, MSP3, MPA3, TP Series
2-1437626-8	BPA14402	Red	Red	1/4-40	MSPMBS, MSPMCS, MSP3, MPA3, TP Series
2-1437626-9	BPA14408	Gray	Gray	1/4-40	MSPMBS, MSPMCS, MSP3, MPA3, TP Series

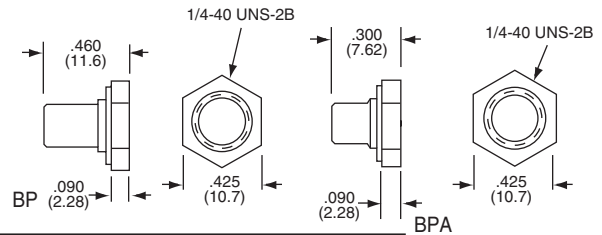

BP20100



BP1900

**1/4-40 PUSHBUTTON BOOT SEALS**

Splashproof seals having 1/4-40 blind nuts integrally mounted to the black Neoprene seal. Supplied with a captive O-Ring to complete the panel seal. Used with actuators up to .37" long. Choice of two-tone with nickel finish knurled ring or all black.

Part Number					
Tyco Electronics	Alcoswitch	Mount Color	Boot Color	Thread Size	Use with Switch Types
2-1437626-3	BP1900	Nickel	Black	1/4-40	MSPM, MSP3, MPA3 and TP Series
2-1437626-4	BP2010	Black	Black	1/4-40	MSPM, MSP3, MPA3 and TP Series

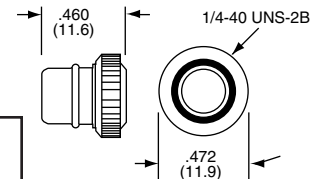

BP15320

**15/32-32 PUSHBUTTON BOOT SEALS**

Splashproof seals incorporating a molded-in hex nut for water tight and dust tight protection. Replaces standard hardware usually supplied. Recommended for large size pushbutton switches with actuators extending up to .31" long.

Part Number					
Tyco Electronics	Alcoswitch	Mount Color	Boot Color	Thread Size	Use with Switch Types
2-1437626-0	BP15320	Black	Black	15/32-32	MSPF and MPG Series
2-1437626-1	BP15322	Red	Red	15/32-32	MSPF and MPG Series
2-1437626-2	BP15328	Gray	Gray	15/32-32	MSPF and MPG Series

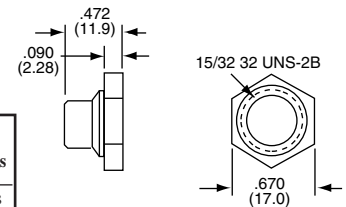

BP5900



BP5890

**15/32-32 PUSHBUTTON BOOT SEALS**

Splashproof seals having 15/32-32 hex shape mounts integrally bonded onto the black Neoprene seal. Supplied with a captive O-Ring for use against the panel. Readily accepts actuators up to .38" in length. Available in two tone with nickel finish hex-mount, or all black.

Part Number					
Tyco Electronics	Alcoswitch	Mount Color	Boot Color	Thread Size	Use with Switch Types
2-1437626-5	BP5890	Nickel	Black	15/32-32	MSPF and MPG Series
2-1437626-6	BP5900	Black	Black	15/32-32	MSPF and MPG Series

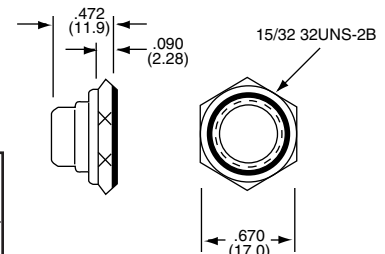

**Pushbutton Switches, Accessories**

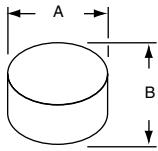

**CAPS**



C5

C22

Model	ID.	Description	Use Guard	Color	"A" Diameter	B Height
C5(*)	Snapfit	Small plastic cap for MPA3 Series	-	(0), (2), (5), (9)	.195	.120
C8(*)	Snapfit	Large plastic cap for MPA3 Series	-	(0), (2), (5), (9)	.310	.160
C9(*)	Snapfit	Spare color cap for MPG Series	-	(0), (2), (6), (9)	.354	.138
C22(*)	Snapfit	MPS/MSPM/MPE/MPA6	G12	(0), (2), (3), (4), (5), (6), (9)	.394	.315
C23(*)	Snapfit	MPS/MSPM/MPE/MPA6	G13	(0), (2), (3), (4), (5), (6), (9)	.590	.394
C33(*)	Snapfit	Square button for MSPR	-	(0), (2), (6), (9)	.378SQ.	.201

(\*) Specify color by adding suffix number: (0) Black, (2) Red, (3) Orange, (4) Yellow, (5) Green, (6) Blue, (9) White.

D  
Accessories

Part Number		Type	Color	Finish	Can be Used with Cap
Tyco Electronics	Alcoswitch				
7-1437627-6	G11A	10-48	Clear aluminum	Plain	C22 —
7-1437627-7	G11B	10-48	Black aluminum	Plain	C22 —
7-1437627-8	G11C	10-48	Chromed Brass	Plain	C22 —
8-1437627-1	G12A	1/4-40	Clear aluminum	Plain	C12 C22
8-1437627-2	G12B	1/4-40	Black aluminum	Plain	C12 C22
8-1437627-3	G12C	1/4-40	Chromed brass	Plain	C12 C22
8-1437627-4	G12KA	1/4-40	Clear aluminum	Knurled	C12 C22
8-1437627-5	G12KB	1/4-40	Black aluminum	Knurled	C12 C22
8-1437627-6	G12KC	1/4-40	Chromed brass	Knurled	C12 C22
8-1437627-7	G13A	1/4-40	Clear aluminum	Plain	C13 C23
8-1437627-8	G13B	1/4-40	Black aluminum	Plain	C13 C23
8-1437627-9	G13C	1/4-40	Chromed brass	Plain	C13 C23
9-1437627-0	G13KA	1/4-40	Clear aluminum	Knurled	C13 C23
9-1437627-1	G13KB	1/4-40	Black aluminum	Knurled	C13 C23
9-1437627-2	G13KC	1/4-40	Chromed brass	Knurled	C13 C23
9-1437627-3	G15*	15/32"	Chromed brass	Plain	C13 C23

\*G15 Model used on the MSPF Series

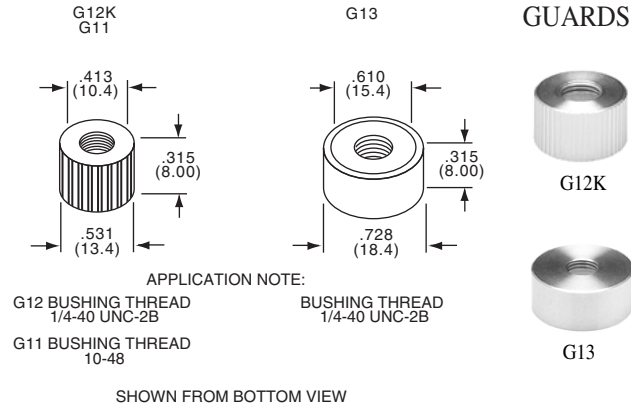

**DECORATIVE HARDWARE**

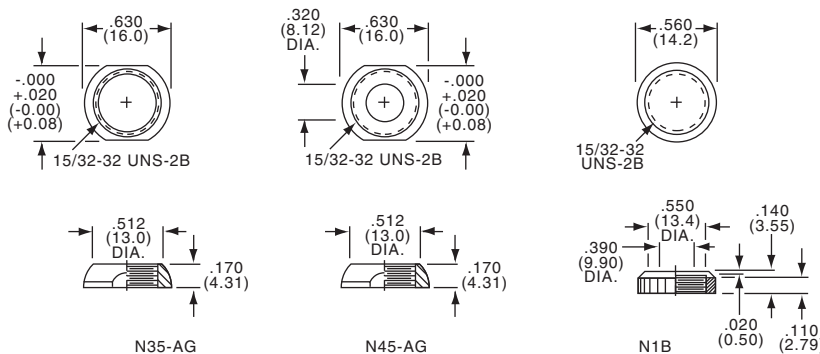

Part Number		Type	Description
Tyco Electronics	Alcoswitch		
1-1437628-0	N1B	15/32"	"Perfect Fit" knurled nut
1-1437628-4	N35-AG	15/32"	Decorative nut (supplied on switch)
1-1437628-7	N45-AG	15/32"	"Perfect Fit" decorative nut

**Pushbutton Switches, Panel Seal**

**FEATURES**

The BP Series offers a unique means of sealing pushbutton switches, using a standard 1/4-40 threading bushing, to almost any thickness panel. Simply install the BP adaptor into a 15/32" dia. or 1/2" dia. panel opening and secure with its hex nut. The switch is then threaded into the previously mounted adaptor and tightened into place. A complete and decorative panel seal is the result of the simple process.

**MATERIALS**

The flexible panel seal is custom molded of Neoprene rubber for long life, flexibility and chemical resistance. The threaded plastic adaptor is molded of ABS thermoplastic, is impact resistant and designed for ease of mounting.

**BPM**

**For use with Miniature Pushbutton**

The BPM seal adaptor accommodates all AUGAT/ALCOSWITCH MPA Series of pushbutton switches utilizing the 1/4-40 threaded bushing.



BPM15320

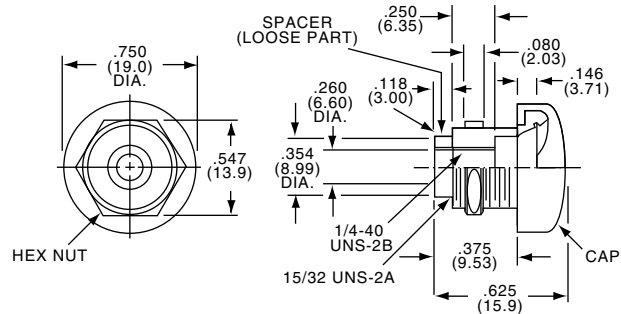

Part Number		
Tyco Electronics	Alcoswitch	Color* of Seal
3-1437626-0	BPM15320	Black
3-1437626-1	BPM15322	Red
3-1437626-2	BPM15328	Gray

(\* Custom seal colors are available upon special request.

**BPT**

**For use with Tiny Series TPF Pushbutton**

The BPT seal adaptor accommodates all AUGAT/ALCOSWITCH TPF Series Tiny Pushbutton switches utilizing the 1/4-40 threading bushing.



BPT15328

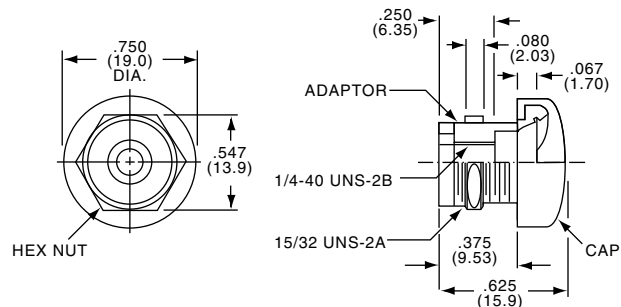

Part Number		
Tyco Electronics	Alcoswitch	Color* of Seal
3-1437626-3	BPT15320	Black
3-1437626-4	BPT15322	Red
3-1437626-5	BPT15328	Grey

(\* Custom seal colors are available upon special request.

**Engineering Notes**



**D**  
Engineering Notes