

# IB IL AI/TEMP 4 RTD-XC-PAC

**Inline analog input terminal,  
version for extreme conditions,  
4 inputs, 2-wire connection method**

Data sheet  
8360\_en\_00

© PHOENIX CONTACT 2016-01-25

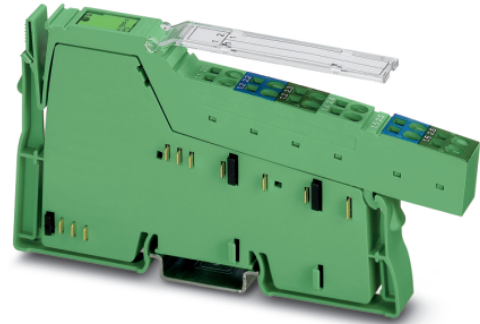

## 1 Function description

The terminal is designed for use within an Inline station. The terminal has four inputs that may be configured independently of each other and either for measuring voltages or resistances or for RTDs.

The sensors are connected using the 2-wire connection method, so that a nominal resistance of at least 1000  $\Omega$  is recommended when sensors with a relatively small temperature coefficient (e.g., platinum sensors) are used.

The resistance measurement with conversion into temperature values can be used for the temperature measurement with NTC resistors. The advantage of these resistors is a large temperature coefficient.

Thanks to special engineering measures and tests, the terminal can be used under extreme ambient conditions.

## Features

- Four measuring inputs that can be configured as
  - Voltage inputs 0 V ... 10 V
  - Inputs for resistance measurements up to 300 k $\Omega$  with output either in ohms or percent (potentiometer measurement)
  - Input for temperature measurements
- The terminal supports
  - Platinum sensors according to DIN EN 60751/ IEC 60751 and the SAMA guideline
  - Nickel sensors according to DIN 43760 and the SAMA guideline
  - KTY81-110, KTY81-210, KTY84 sensors
  - Viessmann Ni 500, Viessmann NTC10 k sensors
  - Siemens LG-Ni 1000 sensor
- Connection of sensors in 2-wire technology
- Communication via process data
- Channels are configured independently of one another using the bus system.
- Diagnostic indicators
- Can be used under extreme ambient conditions
- Painted PCBs
- Extended temperature range of -40°C ... +70°C (see "Tested successfully: Use under extreme ambient conditions" on page 5)



This data sheet is only valid in association with the IL SYS INST UM E user manual.



Make sure you always use the latest documentation.  
It can be downloaded at [phoenixcontact.net/products](http://phoenixcontact.net/products).

---

## Table of contents

1	Function description .....	1
2	Ordering data.....	3
3	Technical data .....	3
4	Tested successfully: Use under extreme ambient conditions .....	5
5	Internal circuit diagram.....	6
6	Local diagnostic indicator .....	7
7	Terminal point assignment.....	7
8	Installation instructions .....	8
9	Connection notes .....	8
10	Connection examples .....	8
11	Process data.....	9
11.1	Process data output words OUT .....	9
11.2	Process data input words IN.....	12
12	Formats for representing measured values.....	13
12.1	IB IL format (default setting) .....	13
12.2	IB ST format .....	14
12.3	S7-compatible format .....	15
12.4	Standardized representation format .....	16
13	Diagnostic codes in the in formats IB IL and standardized representation .....	16
14	Selecting measuring ranges and sensors .....	17
14.1	Systematic errors .....	17
14.2	Tolerance and drift .....	17

## 2 Ordering data

### Terminal blocks

Description	Type	Order No.	Pcs. / Pkt.
Inline analog input terminal, version for extreme conditions, complete with accessories (connector and labeling field), 4 inputs, 0-10 V, resistance temperature detector (RTD), 2-wire connection technology	IB IL AI/TEMP 4 RTD-XC-PAC	2701165	1

### Accessories

Description	Type	Order No.	Pcs. / Pkt.
Connector as replacement item	IB IL SCN-12-OCP	2727624	10

### Documentation

Description	Type	Order No.	Pcs. / Pkt.
"Automation terminals of the Inline product range" user manual	IL SYS INST UM E	2698724	1

## 3 Technical data

### Dimensions (nominal sizes in mm)

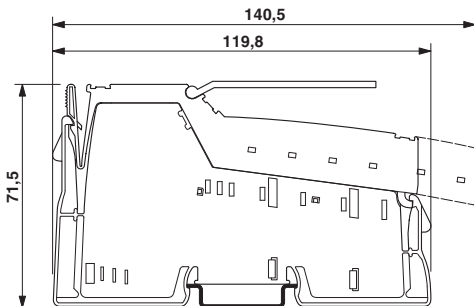

Housing dimensions (width x height x depth)	12.2 x 140.5 x 71.5 mm
---	------------------------

### General data

Color	Green
Weight	68 g (with connector)
Operating mode	Process data mode with 2 words
Connection method for sensors	2-wire technology
Ambient temperature (operation)	-25°C ... +55°C (Standard) -40 °C ... +70°C (Extended, see also the "Tested successfully: Use under extreme ambient conditions" section of the data sheet).
Ambient temperature (storage/transport)	-40 °C ... +85°C
Permissible humidity (operation/storage/transport)	10% ... 95%, according to DIN EN 61131-2
Permissible air pressure (operation/storage/transport)	70 kPa ... 106 kPa (up to 3000 m above sea level)
Degree of protection	IP20
Protection class	III, IEC 61140, EN 61140, VDE 0140-1

**Connection data**

Designation	Inline connector
Connection method	Spring-cage connection
Conductor cross section, solid/stranded	0.08 mm <sup>2</sup> ... 1.5 mm <sup>2</sup>
Conductor cross section [AWG]	28 ... 16

**Inline local bus interface**

Connection method	Inline data jumper
Transmission speed	500 kbps

**Power consumption**

Communications power $U_L$	7.5 V
Current consumption from $U_L$	≤ 60 mA (typical)
Total power consumption	≤ 0.45 W (typical)

**Supply of the module electronics and I/O through bus coupler/power terminal**

Connection method	Potential routing
-------------------	-------------------

**Analog inputs**

Number	4
Connection of signals	2-wire, shielded sensor cable
Sensor types that can be used	Pt, Ni, KTY, voltage 0 V ... 10 V
Standards for characteristic curves	According to DIN EN 60751: 07/1996/ according to SAMA RC 21-4-1966
Conversion time of the A/D converter	150 ms
Process data update time of all four channels	600 ms

**Protective equipment**

None

**Electrical isolation**

The terminal is only supplied with power from the logic circuit (communications power  $U_L = 7.5$  V). All four analog inputs refer to one potential that is electrically isolated from all other circuits ( $U_L$ , main circuit  $U_M$ , segment circuit  $U_S$ , analog circuit  $U_{ANA}$ ). FE (functional earth ground) is a separate potential area that is connected with shield and analog ground via a coupling network consisting of a 1 MΩ resistor and a 1 nF capacitor connected in parallel.

**Separate potentials in the IB IL AI/TEMP 4 RTD-XC-PAC terminal**

Test distance	Test voltage
Analog inputs / $U_L$ , $U_M$ , $U_S$ , $U_{ANA}$	500 V AC, 50 Hz, 1 min

**Error messages to the higher-level control or computer system**

None

**Error messages via process data**

Peripheral fault/user error	Yes (see page 16)
-----------------------------	-------------------

**Mechanical requirements**

Vibration, IEC 60068-2-6; EN 60068-2-6	5g
Shock, IEC 60068-2-27; EN 60068-2-27	30g

**Programming data**

Local bus (INTERBUS)	
ID code	5F <sub>hex</sub> (95 <sub>dec</sub> )
Length code	02 <sub>hex</sub>
Input address area	2 words
Output address area	2 words
Parameter channel (PCP)	0 bytes
Register length (bus)	2 words



For the programming data/configuration data of other bus systems, please refer to the corresponding electronic device data sheet (e.g., GSD, EDS).

**Approvals**

For the latest approvals, please visit [www.phoenixcontact.net/catalog](http://www.phoenixcontact.net/catalog).

**4 Tested successfully: Use under extreme ambient conditions**

XC terminals have been tested successfully over 250 temperature change cycles in accordance with IEC 61131-2 in the range from -40°C to +70°C.

The following conditions were observed:

- The Inline devices for all connecting cables were connected with a minimum conductor cross section of 0.5 mm<sup>2</sup>
- The Inline station was installed on a wall-mounted horizontal DIN rail
- Fans were used to ensure continuous movement of air in the control cabinet
- The Inline station was not exposed to vibration or shock
- The Inline station was operated with a maximum of 24.5 V (ensured by using regulated power supply units)

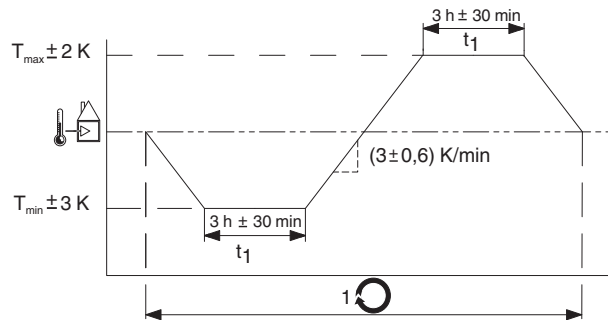

Figure 1 Temperature change cycle



Temperature in the control cabinet/ambient temperature



Cycle



**WARNING:**

The terminal is not approved for use in potentially explosive areas.

The terminal is not approved for use in safety technology.

## 5 Internal circuit diagram

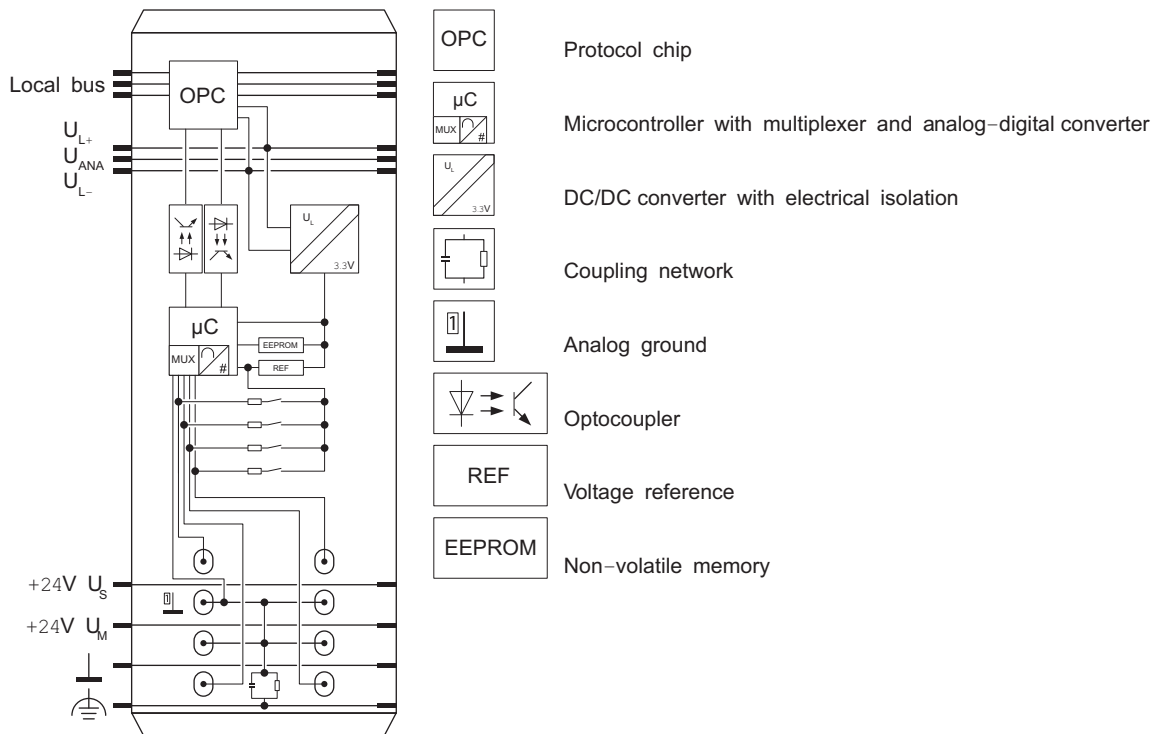

Figure 2 Internal circuit diagram



Other symbols used are explained in the IL SYS INST UM E user manual.

## 6 Local diagnostic indicator



Figure 3 Local diagnostic indicator

Des.	Color	Meaning
D	Green	Diagnostics

### Function identification

Green

## 7 Terminal point assignment

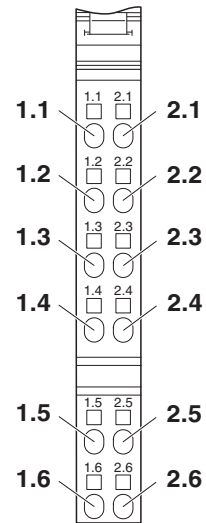

Figure 4 Terminal point assignment

### 2-wire connection

Terminal points	Signal	Assignment
1.1	+AI <sub>1</sub>	Resistance/voltage input of channel 1
1.2	AGND*	Sensor ground of channel 1
1.3	Shield*	Shield connection of channel 1
1.4	+AI <sub>2</sub>	Resistance/voltage input of channel 3
1.5	AGND*	Sensor ground of channel 3
1.6	Shield*	Shield connection of channel 3
2.1	+AI <sub>3</sub>	Resistance/voltage input of channel 2
2.2	AGND*	Sensor ground of channel 2
2.3	Shield*	Shield connection of channel 2
2.4	+AI <sub>4</sub>	Resistance/voltage input of channel 4
2.5	AGND*	Sensor ground of channel 4
2.6	Shield*	Shield connection of channel 4

\* AGND and shield are connected internally.

## 8 Installation instructions

High current flowing through potential jumpers  $U_M$  and  $U_S$  leads to a temperature rise in the potential jumpers and inside the terminal. To keep the current flowing through the potential jumpers of the analog terminals as low as possible, always place the analog terminals after all the other terminals at the end of the main circuit (for the sequence of the Inline terminals, see also IL SYS INST UM E user manual).

## 9 Connection notes

- i
Always connect the analog sensors using shielded, twisted pair cables.
- i
A shield may reduce the influence of electromagnetic interference. Connect the shield at one end with the shield connection of the terminal and insulate it at the sensor.
- i
Connect unused sensor inputs with sensor ground.
- i
Connect the shield externally in areas with strong EMI, and insulate it at the device and the sensor

## 10 Connection examples

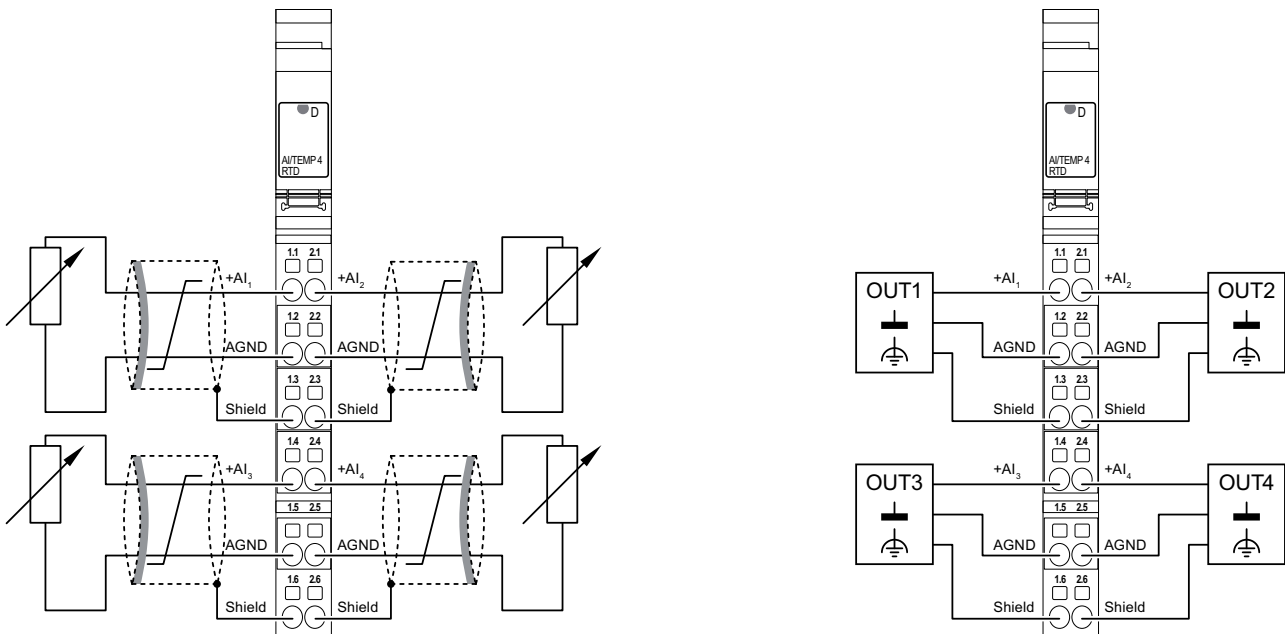

Figure 5 Examples for connecting RTDs and sensors for voltage measurement



## 11 Process data

### 11.1 Process data output words OUT

Two process data output words are available.

Configure the terminal channels via the process data output words OUT1 and OUT2. In this context, the output word OUT1 contains the command and output word OUT2 contains the parameters belonging to this command.

The configuration settings are stored in a volatile memory.

If you change the configuration, the message "Measured value invalid" appears (diagnostic code 8004<sub>hex</sub>), until new measured values are available.



Please note that extended diagnostics is only possible if the IB IL format or standardized representation are configured as the format for representing the measured values. As the IB IL format is preset on the terminal, it is available immediately after the voltage has been applied.

#### 11.1.1 Output word OUT1 (control word)

		OUT1															
Bit		15	14	13	12	11	10	9	8	7	6	5	4	3	2	1	0
Assignment		Command code								0	0	0	0	0	0	0	0

Bit 15 to bit 8 (command code):

Bit 15 to bit 8	OUT1	Command function
0 0 0 0 0 0 C C	0x00 <sub>hex</sub>	Read measured value in IN2 channel-by-channel.
0 0 0 1 0 0 C C	1x00 <sub>hex</sub>	Read configuration in IN2 channel-by-channel.
0 0 1 1 1 1 0 0	3C00 <sub>hex</sub>	Read firmware version and module ID in IN2.
0 1 0 0 0 0 C C	4x00 <sub>hex</sub>	Configure channel, configuration in OUT2.
0 1 0 1 0 0 C C	5x00 <sub>hex</sub>	Configure channel and read measured value of the channel, configuration in OUT2, measured value in IN2.
1 0 0 1 0 0 C C	9x00 <sub>hex</sub>	Read and write R <sub>0</sub> value of the channel.

CC = Channel number

Bit 9 and bit 8: Channel number

Code		Channel number
dec	bin	
0	00	Channel 1
1	01	Channel 2
2	10	Channel 3
3	11	Channel 4

**11.1.2 Output word OUT2 (parameter word)**

The parameters for the commands 4x00<sub>hex</sub>, 5x00<sub>hex</sub>, and 9x00<sub>hex</sub> must be specified in OUT2. This parameter word is only evaluated for these commands.



The parameter word is only evaluated when the control word contains a valid command code. Reserved parameters may not be used.

Commands 4x00<sub>hex</sub>, 5x00<sub>hex</sub>:

		OUT2															
Bit		15	14	13	12	11	10	9	8	7	6	5	4	3	2	1	0
Assignment		R <sub>0</sub>				Filter		Resolution		Format		Sensor type				Measurement mode	

Command 9x00<sub>hex</sub>:

		OUT2															
Bit		15	14	13	12	11	10	9	8	7	6	5	4	3	2	1	0
Assignment		R <sub>0</sub> value, 1 Ω increments															

The following configurations are possible:

Configuration	Short designation	Default
Value of reference resistance R <sub>0</sub>	R <sub>0</sub>	1000 Ω
Selection of mean value generation (filtering)	Filter	No mean value
Resolution settings	Resolution	0.1 Ω/0.01%/0.01 K
Selection of formats for the representation of measured values	Format	IB IL format
Sensor type setting	Sensor type	0 V ... 10 V
Setting the measurement mode	Measurement mode	Voltage measurement 0 V ... 10 V

**R<sub>0</sub>**  
 Selecting the resistance of the sensor at 0°C; The configurable nominal resistance R<sub>0</sub> is taken for the temperature calculation based on nickel and platinum sensors. Should the desired resistance not be found in the code table, the nominal resistance of 1 Ω to 65535 Ω can be configured with increments of 1 Ω. To do this, use the command 9x00<sub>hex</sub> with the R<sub>0</sub> value in the OUT2 process data word.

**Filter**  
 Selection of mean value generation. After every conversion, the measured value is saved in a mean value memory via which the mean value is generated. The memory size can be selected with the filter option. E.g.,

for a 16-sample mean value, the mean value is generated using the last 16 measured values.

**Resolution**  
 Quantization of the measured value, select between °Celsius or °Fahrenheit.



The resolution for voltage measurements depends only on the transmission format.

**Format**  
 Representation of the measured value in the IN process data

**Sensor type**  
 Sensor type setting; The configurable sensor type determines the conversion of the electrical signal present at the input into a physical size. Sensor type and measurement mode must be set for a sensor to be connected to receive a measuring result with a suitable accuracy. If, for instance, a Pt 1000 sensor is to be connected, a resistance measurement for the range from 0 Ω ... 3 kΩ can be used as a measurement mode. Also, a resistance measurement would be possible for the range from 0 Ω ... 300 kΩ, however, this measurement mode provides a considerably lower accuracy in the resistance range relevant for Pt 1000.

**Measurement mode**  
 Setting the selected measurement mode; The measuring mode determines the signal conditioning by the configurable inputs. Every input can be configured for voltage or resistance measurement as desired. For the resistance measurement, an auxiliary current that generates a voltage drop over the resistance to be measured is generated. The current supply is deactivated for the voltage measurement.

### 11.1.3 Parameters for configuration

The values in **bold** are default settings.

Bit 15 to bit 13

Code			Nominal resistance $R_0$ [ $\Omega$ ]
dec	bin	hex	
<b>0</b>	<b>000</b>	<b>0</b>	<b>1000</b>
1	001	1	100
2	010	2	500
3	011	3	2000
4	100	4	5000
5	101	5	10000
6	110	6	Reserved
7	111	7	20000 (can be set)

Bit 12 and bit 11

Code		Filter
dec	bin	
<b>0</b>	<b>00</b>	<b>No mean value</b>
1	01	8-sample mean value
2	10	32-sample mean value
3	11	Reserved

Bit 10 and bit 9

Code		Resolution for sensor type		
dec	bin	1 (Resistance [ $\Omega$ ])	2 (Potentio- meter [%])	3 ... 12 (Tempe- rature)
<b>0</b>	<b>00</b>	<b>0.1</b>	<b>0.01</b>	<b>0.01°C</b>
1	01	1	0.1	0.1°C
2	10	10	1	0.01°F
3	11	Reserved		0.1°F

Bit 8 and bit 7

Code		Format
dec	bin	
<b>0</b>	<b>00</b>	<b>IB IL (15 bits + sign bit with extended diagnostics)</b>
1	01	IB ST (12 bits + sign bit + 3 diagnostic bits)
2	10	S7-compatible (15 bits + sign bit)
3	11	Standardized representation (15 bits + sign bit with extended diagnostics)

Bit 6 to bit 3:

Code		Sensor type
dec	bin	
<b>0</b>	<b>0000</b>	<b>0 V ... 10 V</b>
1	0001	Resistor
2	0010	Potentiometer [%]
3	0011	Pt DIN
4	0100	Pt SAMA
5	0101	Ni DIN
6	0110	Ni SAMA
7	0111	KTY 81-110
8	1000	KTY 81-210
9	1001	KTY 84
10	1010	Ni 1000 (Siemens LG)
11	1011	Ni 500 (Viessmann)
12	1100	NTC 10 k (Viessmann)
13	1101	Reserved
14	1110	Reserved
15	1111	Not configured

Bit 2 to bit 0:

Code		Measurement mode
dec	bin	
0	000	Voltage measurement 0 V ... 10 V
1	001	Reserved
2	010	Reserved
3	011	Resistance measurement 0 $\Omega$ ... 3 k $\Omega$
4	100	Resistance measurement 0 $\Omega$ ... 300 k $\Omega$
5	101	Reserved
6	110	Reserved
<b>7</b>	<b>111</b>	<b>Not configured</b>

**11.2 Process data input words IN**

**11.2.1 Input word IN1 (status word)**

The IN1 word is a copy of the OUT1 process data word.

	IN1															
Bit	15	14	13	12	11	10	9	8	7	6	5	4	3	2	1	0
Assignment	Mirroring of the command code								0	0	0	0	0	0	0	0

**Mirroring of the command code:**

A command code mirrored from the control word.

**11.2.2 Input word IN2**

The measured values, the configuration or the firmware version are transmitted to the controller board or the PC via the process data input word IN2 according to the configuration.

For control word 3C00<sub>hex</sub>, IN2 provides the firmware version and the module ID.

**Example: Firmware version 1.23:**

	IN2															
Bit	15	14	13	12	11	10	9	8	7	6	5	4	3	2	1	0
Assignment (hex)	1				2				3				E <sub>hex</sub>			
Meaning	Firmware version 1.23												Module ID			

For control word 9x00<sub>hex</sub>, IN2 provides the configuration and R<sub>0</sub>.

	IN2															
Bit	15	14	13	12	11	10	9	8	7	6	5	4	3	2	1	0
Assignment	Configuration / R <sub>0</sub>															

Basically four formats are available for the representation of the measured values. For more detailed information on the formats, please refer to "Formats for representing measured values" on page 13.

**IB IL, S7-compatible, standardized representation formats**

	IN2															
Bit	15	14	13	12	11	10	9	8	7	6	5	4	3	2	1	0
Assignment	Analog value															

**IB ST format**

	IN2															
Bit	15	14	13	12	11	10	9	8	7	6	5	4	3	2	1	0
Assignment	Analog value												0	OC	OR	

- MSB Most significant bit
- LSB Least significant bit
- SB Sign bit
- 0 Reserved
- OC Open circuit
- OR Overrange

## 12 Formats for representing measured values

### 12.1 IB IL format (default setting)

The measured value is represented in bits 14 to 0. An additional bit (bit 15) is available as a sign bit. This format supports extended diagnostics. Values  $>8000_{\text{hex}}$  and  $<8100_{\text{hex}}$  indicate an error (see “Diagnostic codes in the in formats IB IL and standardized representation” on page 16).

Measured value representation in IB IL format, 15 bits

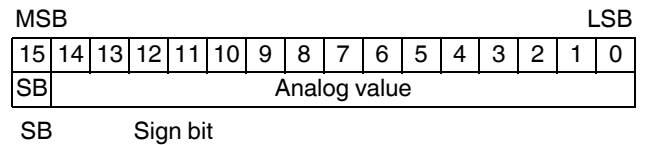

### Typical analog values

Sensor type		Voltage	Resistance	Potentiometer	Temperature
Sensor/code		0	1	2	3 ... 12
Resolution (bits 10 and 9)		-	00 <sub>bin</sub>	01 <sub>bin</sub>	01 <sub>bin</sub> /11 <sub>bin</sub>
Process data item (= analog value)		[V]	[Ω]	[%]	[°C]/[°F]
hex	dec				
8001	-32767	> 10.837	> 3251.2 <sup>1</sup>	> 3251.2	> 3251.2
7F00	32512	10.837	3251.2 <sup>1</sup>	3251.2	3251.2
7530	30000	10.000	3000.0	3000.0	3000.0
0001	1	0.333 mV	0.1	0.1	0.1
0000	0	0	0	0	0
FFFF	-1	-0.333 mV	-	-	-0.1
F448	-3000	-1.000	-	-	-
8080	-32640	< -1.000	-	-	< -273.2

<sup>1</sup> In the resistance measurement mode 0 Ω 3 kΩ is limited to 3000.0 Ω.

**12.2 IB ST format**

The measured value is represented in bits 14 to 3. The remaining 4 bits are sign and error bits.

Measured value representation in IB ST format, 12 bits

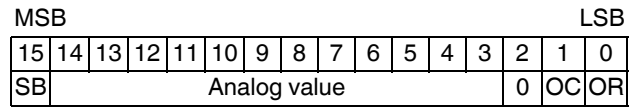

- SB      Sign bit
- 0        Reserved
- OC      Open circuit/short circuit
- OR      Overrange

**Typical analog values**

Sensor type		Voltage	Resistance	Potentiometer	Temperature
Sensor/code		0	1	2	3 ... 12
Resolution (bits 10 and 9)		-	00 <sub>bin</sub>	01 <sub>bin</sub>	01 <sub>bin</sub> /11 <sub>bin</sub>
Process data item (= analog value)		[V]	[Ω]	[%]	[°C]/[°F]
hex	dec				
7FF9	32761	Value is outside the valid range			
7FF8	32760	9.999	3276.0 <sup>1</sup>	3276.0	3276.0
4000	16384	5.000	1638.4	1638.4	1638.4
2710	10000	3.052	1000.0	1000.0	1000.0
0008	8	2.441 mV	0.8	0.8	0.8
0002	2	-	Open circuit		
0001	1	Value is outside the valid range			
0000	0	0.000	0.0	0.0	0.0
FFF8	-8	-2.441 mV	-	-	-0.8
FC18	-1000	-0.305	-	-	-100.0
F333	-3277	-1.000	-	-	-
8001	-32767	Value is outside the valid range			

<sup>1</sup> In the resistance measurement mode 0 Ω 3 kΩ is limited to 3000.0 Ω.



If the measured value is outside the representation area of the process data, bit 0 is set to 1.  
 In the event of an open/short circuit, bit 1 is set to 1.

**12.3 S7-compatible format**

The measured value is represented in bits 14 to 0. An additional bit (bit 15) is available as a sign bit.

Overrange or underrange are indicated with the values 7FFF<sub>hex</sub> or 8000<sub>hex</sub>.

Measured value representation in S7-compatible format; 15 bits

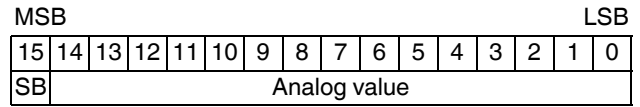

SB Sign bit

**Typical analog values**

Sensor type		Voltage	Resistance	Potentiometer	Temperature
Sensor/code		0	1	2	3 ... 12
Resolution (bits 10 and 9)		-	00 <sub>bin</sub>	01 <sub>bin</sub>	01 <sub>bin</sub> /11 <sub>bin</sub>
Process data item (= analog value)		[V]	[Ω]	[%]	[°C]/[°F]
Hex	Dec				
7FFF	32767	Overrange			
6C00	27648	10.000	2764.8	2764.8	2764.8
2710	10000	3.617	1000.0	1000.0	1000.0
03E8	1000	0.362	100.0	100.0	100.0
0001	1	3.617 mV	0.1	0.1	0.1
0000	0	0.000	0.0	0.0	0.0
FFFF	-1	-3.617 mV	-	-	-0.1
FC18	-1000	-0.362	-	-	-100.0
F535	-2764	-1.000	-	-	-
8000	32768	Underrange			

### 12.4 Standardized representation format

The measured value is represented in bits 14 to 0. An additional bit (bit 15) is available as a sign bit.

The data is standardized with regard to measuring range and resolution and does not need to be converted. The setting of the resolution is 1 Ω for resistance measurements and 1°C for temperature measurements. It has no influence on voltage measurements.

This format supports extended diagnostics. Values >8000<sub>hex</sub> and <8100<sub>hex</sub> indicate an error (see “Diagnostic

codes in the in formats IB IL and standardized representation” on page 16).

Measured value representation in S7-compatible format, 15 bits

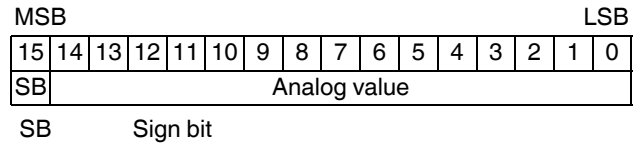

### Typical analog values

Resolution 0.1

Sensor type		Voltage	Resistance	Potentiometer	Temperature
Sensor/code		0	1	2	3 ... 12
Resolution (bits 10 and 9)		-	00 <sub>bin</sub>	01 <sub>bin</sub>	01 <sub>bin</sub> /11 <sub>bin</sub>
Process data item (= analog value)		[V]	[Ω]	[%]	[°C]/[°F]
hex	dec				
8001	32769	>10.837	-	-	-
2710	10000	10.000	1000.0	1000.0	1000.0
0001	1	0.001	0.1	0.1	0.1
0000	0	0.000	0.0	0.0	0.0
FFFF	-1	-	-	-	-0.1
FF00	-256	-	-	-	-25.6
FC18	-1000	-1.000	-	-	-100.0
8080	-32640	<-1.000	-	-	< -273.2

## 13 Diagnostic codes in the in formats IB IL and standardized representation

The following diagnostic codes are possible:

Code (hex)	Error
8001	Overrange
8002	Open circuit (only for resistance measurements)
8004	Measured value invalid/no valid measured value available (e.g., because channel was not configured)
8010	Configuration invalid (after a reset or with an invalid configuration)
8040	Terminal faulty
8080	Underrange



## 14 Selecting measuring ranges and sensors

### 14.1 Systematic errors

Systematic errors can cause large measuring error when measuring resistances and also with temperature measurements with RTDs.

The largest systematic error for resistance measurements with 2-wire connection method is the influence of the sensor connecting cables and contact resistances. Measuring errors may be more or less large depending on the resistance ratio between sensor supply cable and the coefficient of the sensor. This error can only be compensated to a limited extent by subsequent calibration since the resistance of the connecting cable depends on the temperature.

The temperature coefficient of Pt 100 sensors is approximately  $0.385 \Omega/\text{K}$ . The resistance of a 10 m connecting cable with a cross-section of  $0.5 \text{ mm}^2$  is approximately  $0.712 \Omega$  and, therefore, falsifies the measuring result by almost 2 K. In addition there is the temperature-dependent change of the cable and contact resistances.

For Pt 1000, the temperature coefficient is 10 times higher than for Pt 100 and the effect of cable and contact resistances is 10 times lower. Other temperature coefficients, such as NTC sensors, offer considerably higher temperature coefficients.



Select sensor types with the greatest possible temperature coefficients to minimize the influence of systematic measuring errors. We recommend sensors of the appropriate type (preferably NTC) or sensors with a nominal resistance of more than  $1000 \Omega$  (with Ni or Pt).

### 14.2 Tolerance and drift

The influence of measuring errors resulting from tolerance and drift of the measuring circuit can be minimized by selecting appropriate measuring ranges and sensor types. Basically the same recommendations apply as for the systematic errors. The table "Tolerances of the measurement modes" on page 18 provides an overview of the tolerances and drift of the measuring ranges of the device.

The table "Selected sensor parameters" on page 19 gives an overview of temperature coefficients of selected sensor types so that in connection with table "Tolerances of the measurement modes" on page 18 it can be estimated which errors might result for certain sensor measuring combinations.



Please note the information given under "Installation instructions" on page 8 to minimize a temperature rise of the terminal within the Inline station and a temperature drift of the terminal.

**Tolerances of the measurement modes**

Measurement mode	Range <sup>1</sup>	Tolerance			
		Typical		Maximum	
		Absolute	Relative <sup>2</sup>	Absolute	Relative <sup>2</sup>
<b>T<sub>A</sub> = 25°C</b>					
0 V ... 10 V	0 V ... 10 V	±20 mV	±0.2%	±50 mV	±0.5%
0 Ω ... 3 kΩ	0 Ω 2.2 kΩ <sup>3</sup>	±1 Ω	±0.1%	±3.0 Ω	±0.2%
0 Ω ... 300 kΩ	0 kΩ - 5 kΩ	±5 Ω	±0.1%	±10 Ω	±0.2%
	5 kΩ - 20 kΩ	±20 Ω	±0.1%	±40 Ω	±0.2%
	20 kΩ - 100 kΩ	±300 Ω	±0.3%	±600 Ω	±0.6%
	100 kΩ - 300 kΩ	±2500 Ω	±0.8%	±5000 Ω	±1.7%
<b>T<sub>A</sub> in the range from -25°C to +55°C</b>					
0 V ... 10 V	0 V - 10 V	±50 mV	±0.5%	±150 mV	±1.5%
0 Ω ... 3 kΩ	0 kΩ - 2.2 kΩ <sup>3</sup>	±2 Ω	±0.1%	±8 Ω	±0.4%
0 Ω ... 300 kΩ	0 kΩ - 5 kΩ	±10 Ω	±0.2%	±20 Ω	±0.4%
	5 kΩ - 20 kΩ	±80 Ω	±0.4%	±160 Ω	±0.8%
	20 kΩ - 100 kΩ	±1500 Ω	±1.5%	±3000 Ω	±3.0%
	100 kΩ - 300 kΩ	±12000 Ω	±4.0%	±24000 Ω	±8.0%

- 1 A measuring mode may cover several virtual ranges. Each is considered separately since the accuracy highly varies across the entire range.
- 2 Relative data refers to the upper limit of the respective measuring range.
- 3 Tolerances only valid up to 2.2 kΩ.



The percentage tolerance values refer to the respective positive measuring range final value. Unless stated otherwise, nominal operation (nominal voltage, preferred mounting position, default format, default filter setting, identical measuring range setting for channels) is used as the basis. The tolerance values refer to the operating temperature range specified in the tables. The operable range outside this range is not taken into consideration. Please also observe the values for temperature drift and the tolerances under influences of electromagnetic interference.

The maximum tolerance values represent the worst case measurement inaccuracy. They contain the theoretical maximum possible tolerances in the corresponding measuring ranges as well as the theoretical maximum possible tolerances of the calibration and test equipment.

Selected sensor parameters

Sensor type	Temperature range		Resistance range		Temperature coefficient at 25°C
	From	To	From	To	
NTC10 k, B = 3988	0°C	70°C	32650.0 Ω	1752.0 Ω	-461.00
NTC20 k, B = 4300	0°C	70°C	71126.0 Ω	3061.0 Ω	-996.00
Pt 1000 DIN	-100°C	850°C	603.4 Ω	3904.8 Ω	3.88
Pt 1000 SAMA	-200°C	600°C	166.6 Ω	3118.7 Ω	3.88
Ni 1000 DIN	-60°C	180°C	695.2 Ω	2232.2 Ω	5.81
Ni 1000 SAMA Type I	-40°C	200°C	779.0 Ω	2490.2 Ω	6.11
KTY81-110	-55°C	150°C	490.0 Ω	2211.0 Ω	7.80
KTY81-210	-55°C	150°C	980.0 Ω	4280.0 Ω	15.60
KTY84	-40°C	300°C	359.0 Ω	2624.0 Ω	4.40
Siemens LG Ni 1000	-30°C	160°C	871.7 Ω	1863.6 Ω	4.70
Viessmann Ni 500	-40°C	40°C	412.0 Ω	576.0 Ω	2.40
Viessmann NTC 10 k	10°C	110°C	20000.0 Ω	400.0 Ω	-625.00