

CKT. SIZE	DIM. A	DIM. B (MAX.)
2	(2.54)	(5.05)
	.100	.199
3	(5.08)	(7.59)
	.200	.299
4	(7.62)	(10.13)
	.300	.399
5	(10.16)	(12.67)
	.400	.499
6	(12.70)	(15.21)
	.500	.599
7	(15.24)	(17.75)
	.600	.699
8	(17.78)	(20.29)
	.700	.799
9	(20.32)	(22.83)
	.800	.899
10	(22.86)	(25.37)
	.900	.999
11	(25.40)	(27.91)
	1.000	1.099
12	(27.94)	(30.45)
	1.100	1.199
13	(30.48)	(32.99)
	1.200	1.299
14	(33.02)	(35.53)
	1.300	1.399
15	(35.56)	(38.07)
	1.400	1.499
16	(38.10)	(40.61)
	1.500	1.599
17	(40.64)	(43.15)
	1.600	1.699
18	(43.18)	(45.69)
	1.700	1.799
19	(45.72)	(48.23)
	1.800	1.899
20	(48.26)	(50.77)
	1.900	1.999
21	(50.80)	(53.31)
	2.000	2.099
22	(53.34)	(55.85)
	2.100	2.199
23	(55.88)	(58.39)
	2.200	2.299
24	(58.42)	(60.93)
	2.300	2.399
25	(60.96)	(63.47)
	2.400	2.499

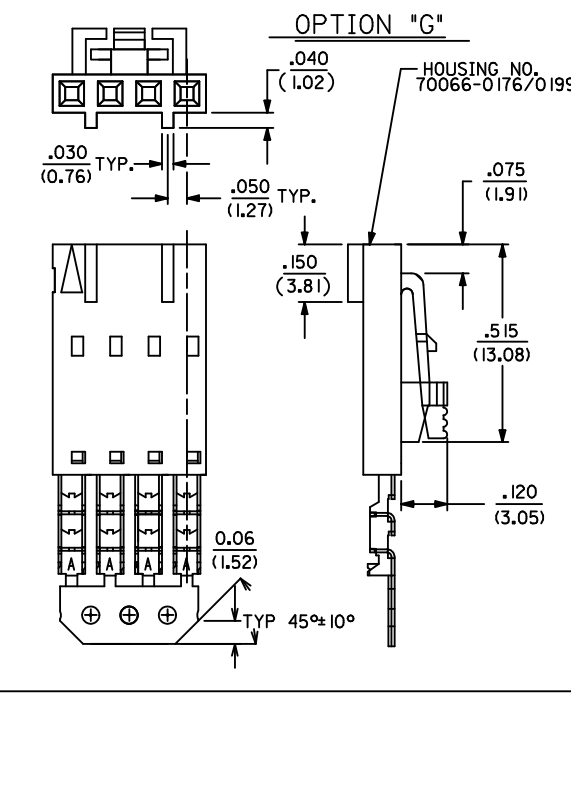

- NOTES:
1. TO BE USED WITH #22-#28 AWG STRANDED WIRE WITH .053/(1.35) DIAMETER MAXIMUM INSULATION
 2. SEE TABLE FOR CIRCUIT SIZES
 3. FOR OPTIONS A, C, D, AND G: STANDARD PACKAGING PER PK-70873-0001
 4. FOR APPLICATION SPECIFICATION, REFER TO SDES-70400
 5. ALL DIMENSIONS ARE REFERENCE ONLY
 6. REFER TO PRODUCT SPECIFICATION PS-70400
 7. SEE SHEET 3 FOR OPTIONAL HOUSING DETAILS
 8. 2 CIRCUIT ASSEMBLIES SUPPLIED AS GROUPED PAIRS

* REFER TO SHEET 2 FOR PART NUMBERS, PLATINGS AND WIRE SIZE

ENG. NO. TO EDP NO. EC NO: UCP2011-1110 DRWINMSI BARRA 2010/11/18 CHKD:JORGAN 2010/11/18 APPR:SMILLER 2010/11/24	QUALITY SYMBOLS ∇=0 ∇=0 ∇=0	GENERAL TOLERANCES (UNLESS SPECIFIED)		DIMENSION STYLE IN/MM		SCALE 4:1	DESIGN UNITS INCH	THIRD ANGLE PROJECTION	
		mm INCH	DRAWN BY JAS	DATE 1987/06/02	TITLE ASSEMBLY CONNECTOR BOX I.D. SINGLE ROW .100 GRID		MOLEX INCORPORATED		SHEET NO. 1 OF 3
DRAFT WHERE APPLICABLE MUST REMAIN WITHIN DIMENSIONS		APPROVED BY SMILLER		DATE 2010/11/24		DOCUMENT NO. SDA-70400-****		THIS DRAWING CONTAINS INFORMATION THAT IS PROPRIETARY TO MOLEX INCORPORATED AND SHOULD NOT BE USED WITHOUT WRITTEN PERMISSION	

OPTION "A"

OPTION "C"

OPTION "D"

ENG. NO.	PLATING	WIRE SIZE
14-56-6XX9	TIN	22
14-60-0XX1	TIN	24
14-60-0XX3	TIN	26
14-60-0XX5	TIN	28
14-56-7XX4	15 GOLD	22
14-56-2XX1	15 GOLD	24
14-56-2XX3	15 GOLD	26
14-56-2XX5	15 GOLD	28
14-56-7XX9	30 GOLD	22
14-56-2XX7	30 GOLD	24
14-56-2XX9	30 GOLD	26
14-56-3XX2	30 GOLD	28

ENG. NO.	PLATING	WIRE SIZE
14-56-7XX0	TIN	22
14-60-0XX7	TIN	24
14-60-0XX9	TIN	26
14-60-1XX1	TIN	28
14-56-7XX5	15 GOLD	22
14-56-3XX5	15 GOLD	24
14-56-3XX6	15 GOLD	26
14-56-3XX8	15 GOLD	28
14-56-8XX0	30 GOLD	22
14-56-4XX0	30 GOLD	24
14-56-4XX2	30 GOLD	26
14-56-4XX4	30 GOLD	28

ENG. NO.	PLATING	WIRE SIZE
14-56-7XX1	TIN	22
14-60-0XX8	TIN	24
14-60-1XX0	TIN	26
14-60-1XX2	TIN	28
14-56-7XX6	15 GOLD	22
14-56-3XX4	15 GOLD	24
14-56-3XX7	15 GOLD	26
14-56-3XX9	15 GOLD	28
14-56-8XX1	30 GOLD	22
14-56-4XX1	30 GOLD	24
14-56-4XX3	30 GOLD	26
14-56-4XX5	30 GOLD	28
14-60-5XX3	50 GOLD	26

*SPECIAL NOTE:
XX = CIRCUIT SIZE FROM 02 TO 25

*SPECIAL NOTE:
XX = CIRCUIT SIZE FROM 02 TO 25

*SPECIAL NOTE:
XX = CIRCUIT SIZE FROM 02 TO 25

OPTION "G"

ENG. NO.	PLATING	WIRE SIZE
14-56-7XX2	TIN	22
14-60-0XX2	TIN	24
14-60-0XX4	TIN	26
14-60-0XX6	TIN	28
14-56-7XX7	15 GOLD	22
14-56-2XX2	15 GOLD	24
14-56-2XX4	15 GOLD	26
14-56-2XX6	15 GOLD	28
14-56-8XX2	30 GOLD	22
14-56-2XX8	30 GOLD	24
14-56-3XX1	30 GOLD	26
14-56-3XX3	30 GOLD	28

*SPECIAL NOTE:
XX = CIRCUIT SIZE FROM 02 TO 25

PLATING PER ES-88:

- TIN - 150 MICROINCHES/(3.81 MICROMETERS) MINIMUM TIN OVER NICKEL UNDERPLATE OVERALL
- 15 GOLD - 15 MICROINCHES/(0.38 MICROMETERS) MINIMUM GOLD OVER 75 MICROINCHES/(1.91 MICROMETERS) MINIMUM TIN OVER NICKEL UNDERPLATE OVERALL
- 30 GOLD - 30 MICROINCHES/(0.76 MICROMETERS) MINIMUM GOLD OVER 75 MICROINCHES/(1.91 MICROMETERS) MINIMUM TIN OVER NICKEL UNDERPLATE OVERALL
- 50 GOLD - 50 MICROINCHES/(1.27 MICROMETERS) MINIMUM GOLD OVER 75 MICROINCHES/(1.91 MICROMETERS) MINIMUM TIN OVER NICKEL UNDERPLATE OVERALL
- TIN (P) - 150 MICROINCHES/(3.81 MICROMETERS) MINIMUM TIN OVER NICKEL UNDERPLATE OVERALL (PRE-PLATE)
- TIN DIP - 20 MICROINCHES/(0.51 MICROMETERS) MINIMUM HOT TIN DIP (PRE-PLATE)

ENG NO. TO EDP NO. EC NO: UCP2011-1110 DRWN:MSIBARRA 2010/11/18 CHKD:JORGAN 2010/11/18 APPR:SMILLER 2010/11/24	QUALITY SYMBOLS ∇=0 ∇=0 ∇=0	GENERAL TOLERANCES (UNLESS SPECIFIED)		DIMENSION STYLE IN/MM		SCALE 1:1	DESIGN UNITS INCH	THIRD ANGLE PROJECTION	
				DRAWN BY DATE JAS 1987/06/02		TITLE ASSEMBLY CONNECTOR BOX I.D. SINGLE ROW .100 GRID		 MOLEX INCORPORATED	
				CHECKED BY DATE MJM 1987/06/02		APPROVED BY DATE SMILLER 2010/11/24			
				1 PLACE ± 0.35 ± ---		MATERIAL NO. SEE TABLE		DOCUMENT NO. SDA-70400-****	
		ANGULAR ±1/2°		DRAFT WHERE APPLICABLE MUST REMAIN WITHIN DIMENSIONS		THIS DRAWING CONTAINS INFORMATION THAT IS PROPRIETARY TO MOLEX INCORPORATED AND SHOULD NOT BE USED WITHOUT WRITTEN PERMISSION			

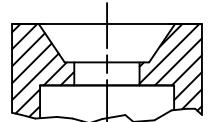
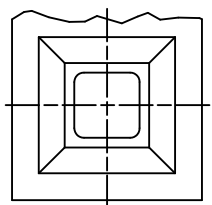

OPTIONAL PIN WINDOW DETAIL
SCALE 20:1

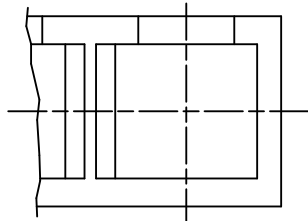
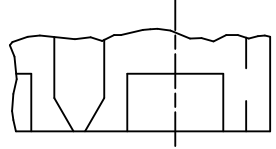

OPTIONAL KNOCK-OUT DETAIL
SCALE 20:1

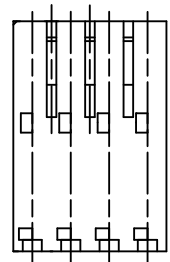
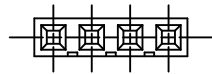

OPTIONAL CORE-OUT FOR HOUSING OPTIONS A,B,C,&D
CKT. SIZES 2-25
(FOR CONTROL OF BOW)

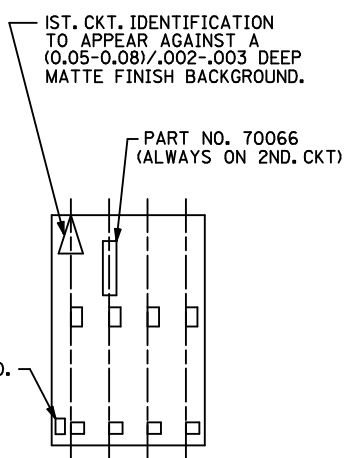

OPTIONAL FIRST CIRCUIT IDENTIFICATION

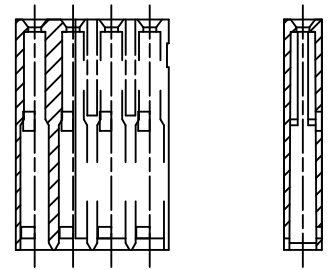

OPTIONAL INNER CORE CORE-OUT

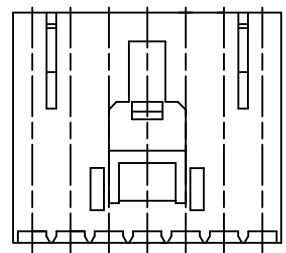
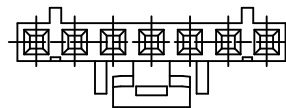

OPTIONAL CORE-OUT FOR HSG. OPTION "G" -CKT. SIZES 5,7,9,11,13,15,17,19,21,23,&25 (7 CKT. SHOWN)
(FOR CONTROL OF BOW)

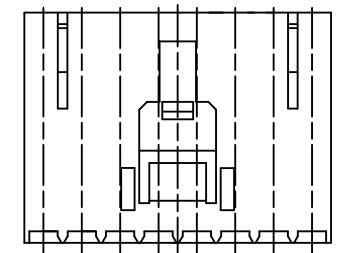
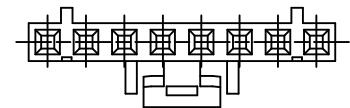

OPTIONAL CORE-OUT FOR HSG. OPTION "G" -CKT. SIZES 6,8,10,12,14,16,18,20,22,&24 (8 CKT. SHOWN)
(FOR CONTROL OF BOW)

SEE SHEET 1 EC NO: UCP2011-110 2010/11/18 DRWN:MS BARRA 2010/11/18 CHKD:DMORGAN 2010/11/18 APPR:SMILLER 2010/11/24	QUALITY SYMBOLS = 0 = 0 = 0 = 0	GENERAL TOLERANCES (UNLESS SPECIFIED) <table border="1"> <tr> <th></th> <th>mm</th> <th>INCH</th> </tr> <tr> <td>4 PLACES</td> <td>± .---</td> <td>± .---</td> </tr> <tr> <td>3 PLACES</td> <td>± .---</td> <td>± .010</td> </tr> <tr> <td>2 PLACES</td> <td>± 0.25</td> <td>± .014</td> </tr> <tr> <td>1 PLACE</td> <td>± 0.35</td> <td>± .---</td> </tr> </table>		mm	INCH	4 PLACES	± .---	± .---	3 PLACES	± .---	± .010	2 PLACES	± 0.25	± .014	1 PLACE	± 0.35	± .---	DIMENSION STYLE IN/MM DRAWN BY DATE JAS 1987/06/02 CHECKED BY DATE MJM 1987/06/02 APPROVED BY DATE SMILLER 2010/11/24	SCALE 4:1 DESIGN UNITS INCH THIRD ANGLE PROJECTION	TITLE ASSEMBLY CONNECTOR BOX I.D. SINGLE ROW .100 GRID MOLEX INCORPORATED MATERIAL NO. SDA-70400-**** DOCUMENT NO.	SHEET NO. 3 OF 3
		mm	INCH																		
	4 PLACES	± .---	± .---																		
	3 PLACES	± .---	± .010																		
2 PLACES	± 0.25	± .014																			
1 PLACE	± 0.35	± .---																			
DRAFT WHERE APPLICABLE MUST REMAIN WITHIN DIMENSIONS	SEE TABLE	THIS DRAWING CONTAINS INFORMATION THAT IS PROPRIETARY TO MOLEX INCORPORATED AND SHOULD NOT BE USED WITHOUT WRITTEN PERMISSION																			

	13	12	11	10	9	8	7	6	5	4	3	2	1
	OPTION "A"				OPTION "C"				OPTION "D"				
J	ENG. NO.	PLATING	WIRE SIZE		ENG. NO.	PLATING	WIRE SIZE		ENG. NO.	PLATING	WIRE SIZE		
	A-70400-3000-3023	TIN	22		A-70400-3035-3058	TIN	22		A-70400-3070-3093	TIN	22		
	A-70400-0001-0024	TIN	24		A-70400-0036-0059	TIN	24		A-70400-0071-0094	TIN	24		
	A-70400-0176-0199	TIN	26		A-70400-0211-0234	TIN	26		A-70400-0246-0269	TIN	26		
	A-70400-0351-0374	TIN	28		A-70400-0386-0409	TIN	28		A-70400-0421-0444	TIN	28		
I	A-70400-3175-3198	15 GOLD	22		A-70400-3210-3233	15 GOLD	22		A-70400-3245-3268	15 GOLD	22		
	A-70400-0526-0549	15 GOLD	24		A-70400-0561-0584	15 GOLD	24		A-70400-050 GOLD-0619	15 GOLD	24		
	A-70400-0701-0724	15 GOLD	26		A-70400-0736-0759	15 GOLD	26		A-70400-0771-0794	15 GOLD	26		
	A-70400-0876-0899	15 GOLD	28		A-70400-0911-0934	15 GOLD	28		A-70400-0946-0969	15 GOLD	28		
	A-70400-3350-3373	30 GOLD	22		A-70400-3385-3408	30 GOLD	22		A-70400-3420-3443	30 GOLD	22		
	A-70400-1051-1074	30 GOLD	24		A-70400-1086-1109	30 GOLD	24		A-70400-1121-1144	30 GOLD	24		
	A-70400-1226-1249	30 GOLD	26		A-70400-1261-1284	30 GOLD	26		A-70400-1296-1319	30 GOLD	26		
H	A-70400-1401-1424	30 GOLD	28		A-70400-1436-1459	30 GOLD	28		A-70400-1471-1494	30 GOLD	28		
									A-70400-4050-4073	50 GOLD	26		
G													
F	OPTION "G"				<p>PLATING PER ES-88:</p> <p>TIN - .000150 MINIMUM TIN OVER .000050 MINIMUM NICKEL PLATE.</p> <p>15 GOLD - .000015 MINIMUM GOLD PLATE IN SELECT AREA, .000075 MINIMUM TIN PLATE IN SELECT AREA, .000050 MINIMUM NICKEL PLATE OVERALL.</p> <p>30 GOLD - .000030 MINIMUM GOLD PLATE IN SELECT AREA, .000075 MINIMUM TIN PLATE IN SELECT AREA, .000050 MINIMUM NICKEL PLATE OVERALL.</p> <p>50 GOLD - .000050 MINIMUM GOLD PLATE IN SELECT AREA, .000075 MINIMUM TIN PLATE IN SELECT AREA, .000050 MINIMUM NICKEL PLATE OVERALL.</p> <p>TIN (P) - .000150 MINIMUM TIN OVER .000050 MINIMUM NICKEL PLATE. (PRE-PLATE)</p> <p>TIN DIP - .000020 MINIMUM HOT TIN DIP. (PRE-PLATE)</p>								
	ENG. NO.	PLATING	WIRE SIZE										
	A-70400-3140-3163	TIN	22										
	A-70400-0141-011N	TIN	24										
E	A-70400-0316-0339	TIN	26										
	A-70400-0491-0514	TIN	28										
	A-70400-2976-2999	15 GOLD	22										
	A-70400-0666-0689	15 GOLD	24										
	A-70400-0841-0864	15 GOLD	26										
	A-70400-1016-1039	15 GOLD	28										
	A-70400-3490-3513	30 GOLD	22										
D	A-70400-1191-1214	30 GOLD	24										
	A-70400-1366-1389	30 GOLD	26										
	A-70400-1541-1564	30 GOLD	28										
C													
B													
A													

REMOVE OPTION "E" EC NO: UCP2007-1643 DRAWN: DANIELLEY 2007/01/30 CHKD: BORGAN 2007/02/01 APPR: SMILLER 2007/02/06 REV: N	QUALITY SYMBOLS 	GENERAL TOLERANCES (UNLESS SPECIFIED)		DIMENSION STYLE		SCALE	DESIGN UNITS	THIRD ANGLE PROJECTION		
				IN/MM		4:1	INCH			
				DRAWN BY DATE		TITLE				
				JAS 1987/11/28		ASSEMBLY CONNECTOR BOX /I.D. SINGLE ROW - .100 GRID				
		3 PLACES ± --- ± .010		CHECKED BY DATE				MOLEX INCORPORATED		
		2 PLACES ± 0.25 ± .014		MJM 1987/11/28						
		1 PLACE ± 0.35 ± ---		APPROVED BY DATE						
		ANGULAR ±1/2°		WAZ 1987/11/28				DOCUMENT NO. SDA-70400-**** SHEET NO. 2 OF 3		
		DRAFT WHERE APPLICABLE MUST REMAIN WITHIN DIMENSIONS		SEE TABLE						
				MATERIAL NO.						
				SIZE						
				C						

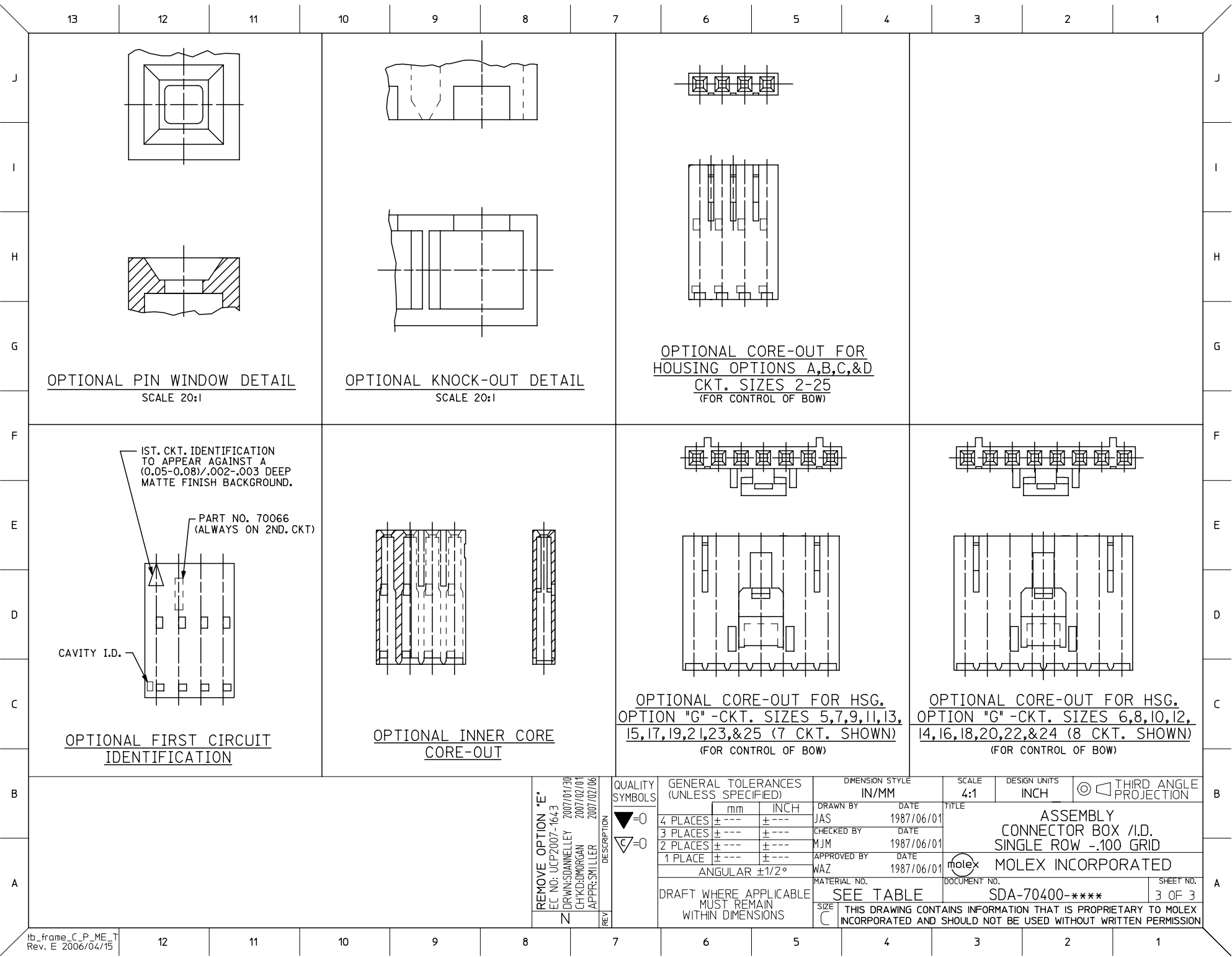

OPTIONAL PIN WINDOW DETAIL
SCALE 20:1

OPTIONAL KNOCK-OUT DETAIL
SCALE 20:1

OPTIONAL CORE-OUT FOR HOUSING OPTIONS A,B,C,&D
CKT. SIZES 2-25
(FOR CONTROL OF BOW)

OPTIONAL FIRST CIRCUIT IDENTIFICATION

IST. CKT. IDENTIFICATION TO APPEAR AGAINST A (0.05-0.08)/.002-.003 DEEP MATTE FINISH BACKGROUND.

PART NO. 70066 (ALWAYS ON 2ND. CKT.)

CAVITY I.D.

OPTIONAL INNER CORE CORE-OUT

OPTIONAL CORE-OUT FOR HSG. OPTION "G" -CKT. SIZES 5,7,9,11,13,15,17,19,21,23,&25 (7 CKT. SHOWN)
(FOR CONTROL OF BOW)

OPTIONAL CORE-OUT FOR HSG. OPTION "G" -CKT. SIZES 6,8,10,12,14,16,18,20,22,&24 (8 CKT. SHOWN)
(FOR CONTROL OF BOW)

REMOVE OPTION "E"
FC NO: UCP2007-1643
DRAWN: DANIELLEY 2007/01/30
CHKD: BORGAN 2007/02/01
APPR: SMILLER 2007/02/06

QUALITY SYMBOLS

 DESCRIPTION

GENERAL TOLERANCES (UNLESS SPECIFIED)	
mm	INCH
4 PLACES ± ---	± ---
3 PLACES ± ---	± ---
2 PLACES ± ---	± ---
1 PLACE ± ---	± ---
ANGULAR ±1/2°	

DRAFT WHERE APPLICABLE MUST REMAIN WITHIN DIMENSIONS

DIMENSION STYLE	
IN/MM	
DRAWN BY	DATE
JAS	1987/06/01
CHECKED BY	DATE
MJM	1987/06/01
APPROVED BY	DATE
WAZ	1987/06/01
MATERIAL NO.	
SEE TABLE	

SCALE	DESIGN UNITS	THIRD ANGLE PROJECTION
4:1	INCH	
ASSEMBLY CONNECTOR BOX I.D. SINGLE ROW -.100 GRID		
MOLEX INCORPORATED		SHEET NO. 3 OF 3
DOCUMENT NO. SDA-70400-****		

OPTION A



NOTES:

- MATERIAL:
HOUSING: POLYESTER(PBT), GLASS FILLED, UL94 V-0;
COLOR: BLACK
TERMINAL: PHOSPHOR BRONZE
- FINISH:
TIN: 3.81 MICROMETERS/150 MICROINCHES MINIMUM TIN OVER NICKEL UNDERPLATE OVERALL
- TO BE USED WITH 22 AWG STRANDED WIRE WITH (1.35)/.053 DIAMETER MAXIMUM INSULATION
- SEE TABLE FOR AVAILABLE CIRCUIT SIZES
- STANDARD PACKAGING PER PK-70873-0001. OPTIONAL PACKAGING MAY BE AVAILABLE, REQUEST DRAWING PK-70400
- PARTS STACKABLE END TO END ON (2.54)/.100 CENTERS
- PRODUCT SPECIFICATION: PS-70400
- SEE DRAWING SDA-70400-**** (SHEET 3) FOR OPTIONAL HOUSING DETAILS
- 4 CIRCUIT SHOWN
- TO MATE WITH MOLEX 2.54/.100 CENTERLINE HEADERS
- 2 CIRCUIT ASSEMBLIES SUPPLIED AS GROUPED PAIRS

CKT. SIZE	A	B	EDP. NO.
2	(2.54) .100	(5.05) .199	14-56-6029
3	(5.08) .200	(7.59) .299	14-56-6039
4	(7.62) .300	(10.13) .399	14-56-6049
5	(10.16) .400	(12.67) .499	14-56-6059
6	(12.70) .500	(15.21) .599	14-56-6069
7	(15.24) .600	(17.75) .699	14-56-6079
8	(17.78) .700	(20.29) .799	14-56-6089
9	(20.32) .800	(22.83) .899	14-56-6099
10	(22.86) .900	(25.37) .999	14-56-6109
11	(25.40) 1.000	(27.91) 1.099	14-56-6119
12	(27.94) 1.100	(30.45) 1.199	14-56-6129
13	(30.48) 1.200	(32.99) 1.299	14-56-6139
14	(33.02) 1.300	(35.53) 1.399	14-56-6149
15	(35.56) 1.400	(38.07) 1.499	14-56-6159
16	(38.10) 1.500	(40.61) 1.599	14-56-6169
17	(40.64) 1.600	(43.15) 1.699	14-56-6179
18	(43.18) 1.700	(45.69) 1.799	14-56-6189
19	(45.72) 1.800	(48.23) 1.899	14-56-6199
20	(48.26) 1.900	(50.77) 1.999	14-56-6209
21	(50.80) 2.000	(53.31) 2.099	14-56-6219
22	(53.34) 2.100	(55.85) 2.199	14-56-6229
23	(55.88) 2.200	(58.39) 2.299	14-56-6239
24	(58.42) 2.300	(60.93) 2.399	14-56-6249
25	(60.96) 2.400	(63.47) 2.499	14-56-6259

CIRCUIT NO. 1
SLOT OR ARROW

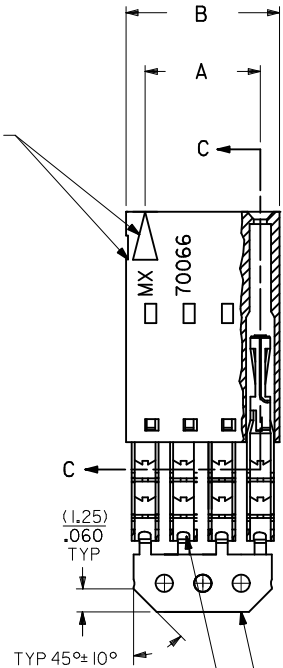

SECTION C-C



PRE-LOADED ASSEMBLY

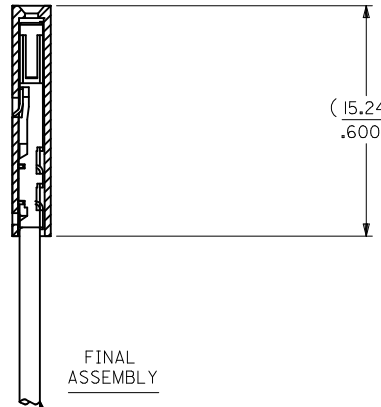

FINAL ASSEMBLY

WIRE (SEE NOTE 3)

I.D. SLOT CODE TO WIRE GAUGE CHART	
I.D. SLOT CODE	WIRE GAUGE
D	22 AWG.

PLATING CODE (STRIPE ON CARRIER STRIP)	
PLATING	COLOR
TIN	NONE

REMOVE ENG NO. EC NO: UCP2011-110 TDRWINHISBARRA 2010/10/19 CHKD:MORGAN 2010/10/19 APPR:SMILLER 2010/11/24	QUALITY SYMBOLS ▽=0 ▽=0 ▽=0	GENERAL TOLERANCES (UNLESS SPECIFIED)		DIMENSION STYLE MM/IN		SCALE	DESIGN UNITS	THIRD ANGLE PROJECTION			
		4 PLACES ± --- ± --- 3 PLACES ± --- ± .010 2 PLACES ± 0.25 ± .014 1 PLACE ± 0.35 ± ---		DRAWN BY DATE MSIBARRA 2010/10/20		TITLE	ASSEMBLY, SL CONNECTOR SINGLE ROW 2.54/.100 GRID				
		ANGULAR ±1/2°		CHECKED BY DATE WAZ 1987/10/26		APPROVED BY DATE SMILLER 2010/11/24		MOLEX MOLEX INCORPORATED			
		DRAFT WHERE APPLICABLE MUST REMAIN WITHIN DIMENSIONS		MATERIAL NO. SEE TABLE		DOCUMENT NO. SDA-70400-3000-3023		SHEET NO. 1 OF 1			

THIS DRAWING CONTAINS INFORMATION THAT IS PROPRIETARY TO MOLEX INCORPORATED AND SHOULD NOT BE USED WITHOUT WRITTEN PERMISSION