

CZRF2V4B Thru CZRF39VB

Voltage 2.4 to 39 Volts

Power 200 mWatts

RoHS Device

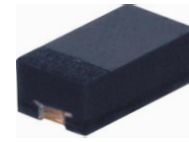

Features

- 200mW Power Dissipation.
- High Voltages from 2.4 ~ 39 V.
- Designed for mounting on small surface.
- Extremely thin/leadless package.
- Constant voltage control.
- Pb free product.

Mechanical data

- Case: 1005/SOD-323F Standard package
Molded plastic.
- Terminals: Gold plated, solderable per MIL-STD-750,method 2026.
- Polarity: Indicated by cathode band.
- Weight: 0.006 gram(approx.).

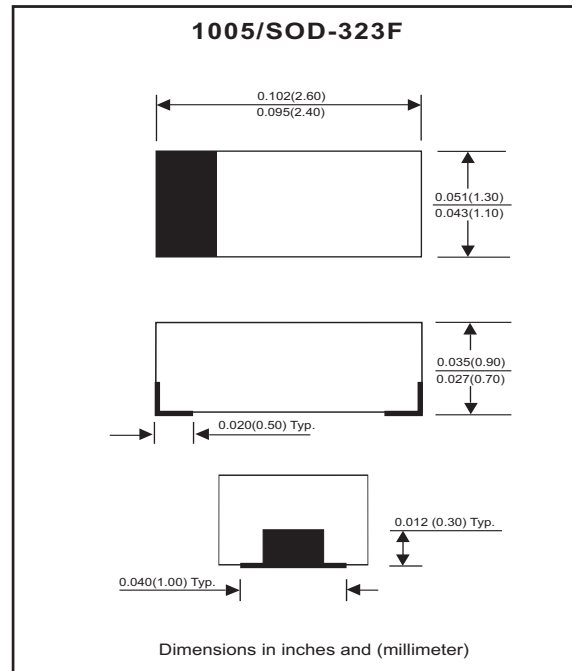

Maximum Rating AND Electrical Characteristics

Parameter	Symbol	Value	Unit
Maximum Forward Voltage Drop at $I_F = 10 \text{ mA}$	V_F	0.9	V
Maximum Power Dissipation at 25 C°	P_D	200	mW
Forward current , surge peak 8.3 ms single half sine-wave superimposed on rate load(JEDEC method)	I_{FSM}	2.0	A
Peak ESD voltage capability (IEC 61000-4-2)	V_{PV}	8	kV
Operating Junction and Storage Temperature Range	T_J	-55 to +125	$^\circ\text{C}$

Electrical Characteristics(Ta = 25C) °

Part Number	Marking Code	Zener Voltage			Operating resistance		Rising operating Resistance		Reverse current	
		Vz(V)			ZZT(Ohm)		ZZK(Ohm)		IR(uA)	
		Min	Max	Iz(mA)	Max	Iz(mA)	Max	Iz(mA)	Max	VR(V)
CZRF2V4B	U2	2.34	2.46	5	100	5	1800	0.25	100	1
CZRF2V7B	U3	2.63	2.77	5	100	5	1900	0.25	75	1
CZRF3V0B	U4	2.93	3.08	5	95	5	2000	0.25	50	1
CZRF3V3B	U5	3.22	3.38	5	95	5	2200	0.25	25	1
CZRF3V6B	U6	3.51	3.69	5	90	5	2300	0.25	15	1
CZRF3V9B	U7	3.80	4.00	5	90	5	2400	0.25	10	1
CZRF4V3B	U8	4.19	4.41	5	88	5	2500	0.25	5	1
CZRF4V7B	U9	4.58	4.82	5	70	5	2200	0.25	3	1.5
CZRF5V1B	UA	4.97	5.23	5	50	5	2050	0.25	2	2
CZRF5V6B	UB	5.46	5.74	5	25	5	1800	0.25	2	3
CZRF6V2B	UC	6.05	6.36	5	10	5	1300	0.25	1	4
CZRF6V8B	UE	6.63	6.97	5	8	5	750	0.25	1	5.2
CZRF7V5B	UF	7.31	7.69	5	7	5	600	0.25	0.5	6
CZRF8V2B	UG	8.00	8.41	5	7	5	600	0.25	0.5	6.5
CZRF9V1B	UH	8.87	9.33	5	10	5	600	0.25	0.1	7
CZRF10VB	UJ	9.75	10.25	5	15	5	600	0.25	0.1	8
CZRF11VB	UK	10.73	11.27	5	18	5	600	0.25	0.1	8.4
CZRF12VB	UM	11.70	12.30	5	22	5	600	0.25	0.1	9.1
CZRF13VB	UN	12.68	13.32	5	25	5	600	0.25	0.1	9.9
CZRF15VB	UP	14.63	15.37	5	32	5	600	0.25	0.1	11
CZRF16VB	UQ	15.60	16.40	5	36	5	600	0.25	0.1	12
CZRF18VB	UR	17.55	18.45	5	42	5	600	0.25	0.1	14
CZRF20VB	US	19.50	20.50	5	48	5	600	0.25	0.1	15
CZRF22VB	UT	21.45	22.55	5	55	5	600	0.25	0.1	17
CZRF24VB	UU	23.40	24.60	5	62	5	600	0.25	0.1	18
CZRF27VB	UV	26.33	27.67	5	70	5	600	0.25	0.1	21
CZRF30VB	UW	29.25	30.75	5	78	5	600	0.25	0.1	23
CZRF33VB	UX	32.18	33.82	5	88	5	700	0.25	0.1	25
CZRF36VB	UY	35.10	36.90	5	95	5	700	0.25	0.1	27
CZRF39VB	UZ	38.03	39.97	5	130	5	800	0.25	0.1	30

RATING AND CHARACTERISTIC CURVES (CZRF2V4B Thru CZRF39VB)

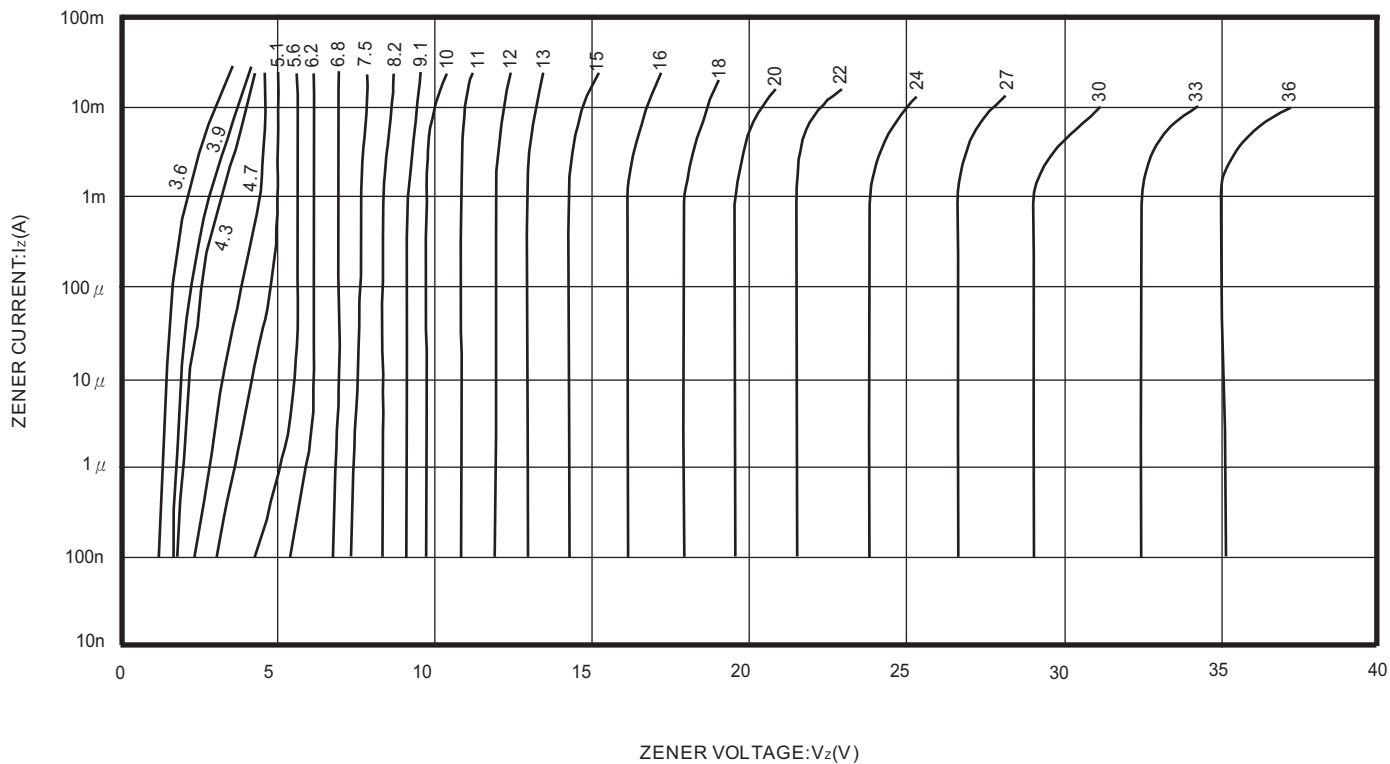

ZENER VOLTAGE: V_z (V)
Fig. 1 Zener voltage characteristics

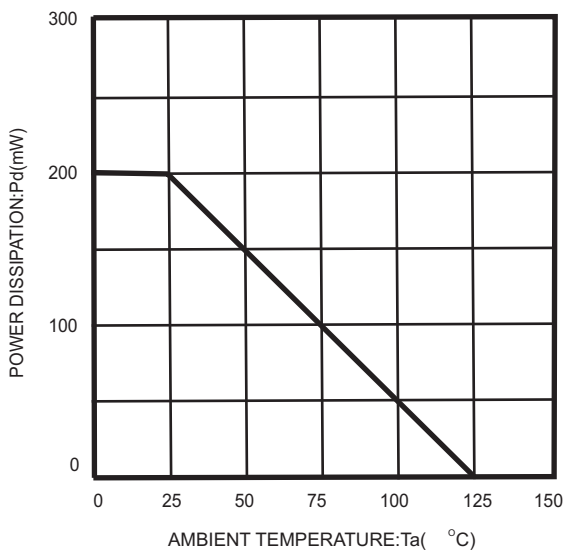

Fig. 2 Derating curve

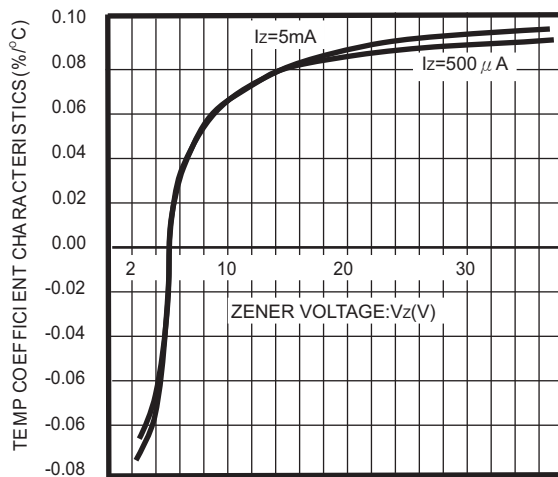
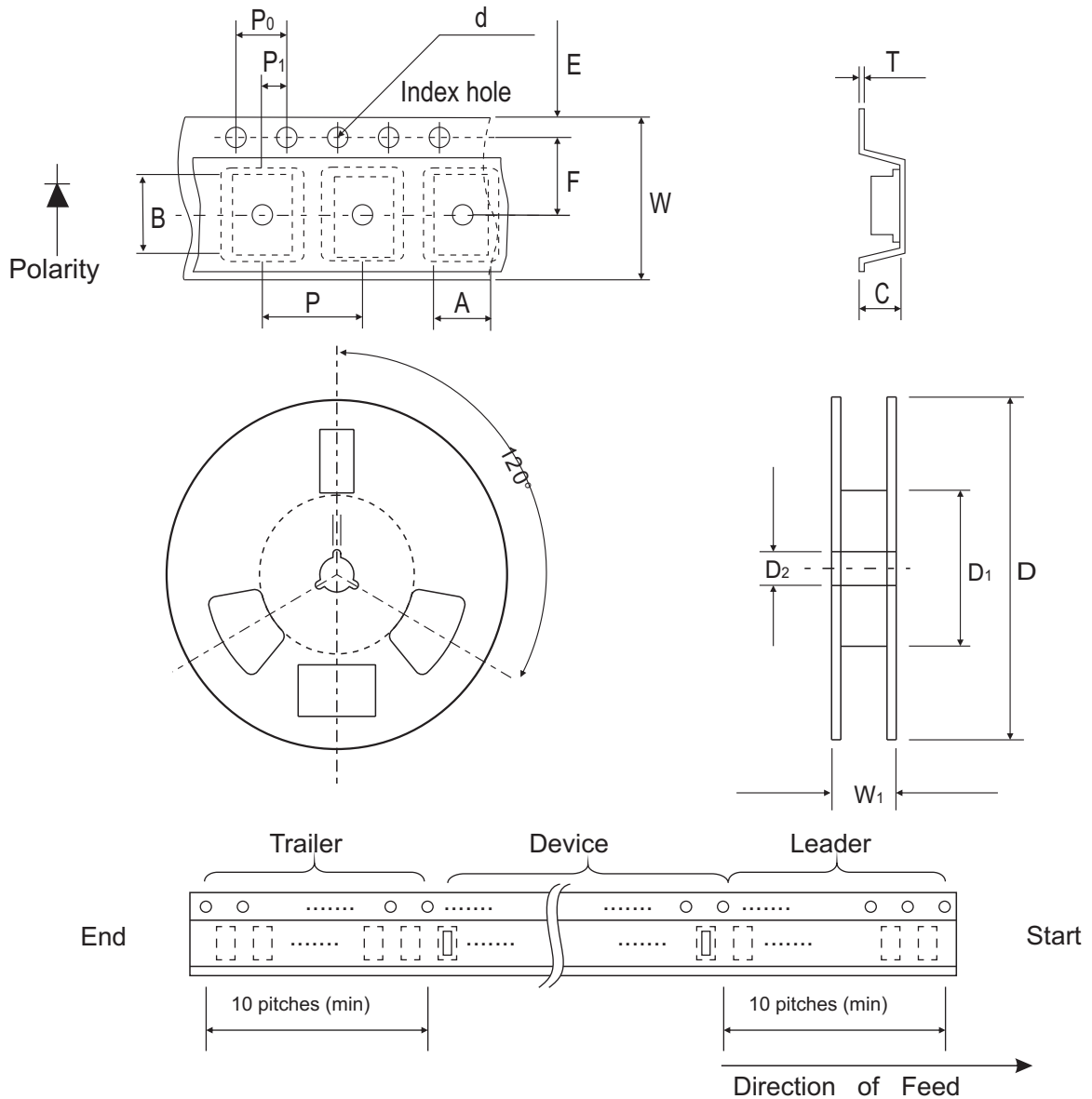

Fig. 3 Zener voltage-temp. Coefficient characteristics

Reel Taping Specification



1005 (SOD-323F)	SYMBOL	A	B	C	d	D	D ₁	D ₂
	(mm)	1.55 ± 0.10	2.65 ± 0.10	1.05 ± 0.10	1.55 ± 0.05	178 ± 1	60.0 MIN.	13.0 ± 0.20
	(inch)	0.061 ± 0.004	0.104 ± 0.004	0.041 ± 0.004	0.061 ± 0.002	7.008 ± 0.04	2.362 MIN.	0.512 ± 0.008

1005 (SOD-323F)	SYMBOL	E	F	P	P ₀	P ₁	T	W	W ₁
	(mm)	1.75 ± 0.10	3.50 ± 0.05	4.00 ± 0.10	4.00 ± 0.10	2.00 ± 0.05	0.23 ± 0.05	8.00 ± 0.20	13.5 MAX.
	(inch)	0.069 ± 0.004	0.138 ± 0.002	0.157 ± 0.004	0.157 ± 0.004	0.079 ± 0.004	0.009 ± 0.002	0.315 ± 0.008	0.531 MAX.

Suggested PAD Layout

SIZE	1005/SOD-323F	
	(mm)	(inch)
A	2.10	0.083
B	1.20	0.047
C	1.20	0.047
D	3.30	0.130
E	0.90	0.035

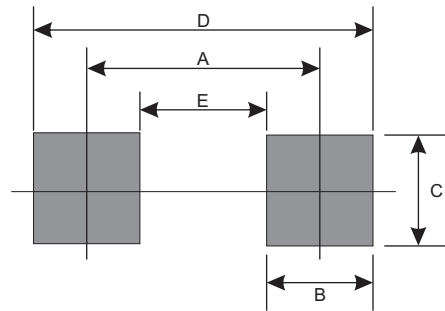

Standard Package

Case Type	Qty per Reel	Reel Size
	(Pcs)	(inch)
1005/SOD-323F	4000	7