

Printed-circuit board connector - DMCV 0,5/ 2-G1-2,54 SMD R32 - 1845179

Please be informed that the data shown in this PDF Document is generated from our Online Catalog. Please find the complete data in the user's documentation. Our General Terms of Use for Downloads are valid (<http://phoenixcontact.com/download>)



Header, Nominal current: 6 A, Rated voltage (III/2): 160 V, Number of positions: 2, Pitch: 2.54 mm, Color: black, Contact surface: Gold, Mounting: SMD soldering, Sample values available under SAMPLE DMC...

The figure shows a 3-pos. version of the product

Why buy this product

- Gold-plated contacts ensure transfer quality remains stable over the long term
- Designed for integration into the SMT soldering process
- Vertical connection enables multi-row arrangement on the PCB
- Small component size for applications where space is at a premium

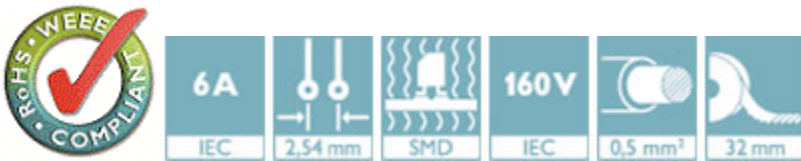

Key Commercial Data

Packing unit	1 STK
Minimum order quantity	330 STK
Custom tariff number	85366990
Country of origin	Germany

Technical data

Environmental Product Compliance

China RoHS	No hazardous substances above threshold values
------------	--

Dimensions

Length	7.39 mm
Pitch	2.54 mm
Dimension a	2.54 mm
Width	9.66 mm

Printed-circuit board connector - DMCV 0,5/ 2-G1-2,54 SMD R32 - 1845179

Technical data

Dimensions

Height	7.1 mm
Pin dimensions	0,64 x 0,64 mm
Pin spacing	2.54 mm

General

Range of articles	DMCV 0,5/...G1-SMD
Insulating material group	IIIa
Rated surge voltage (III/3)	2.5 kV
Rated surge voltage (III/2)	2.5 kV
Rated surge voltage (II/2)	2.5 kV
Rated voltage (III/3)	32 V
Rated voltage (III/2)	160 V
Rated voltage (II/2)	160 V
Connection in acc. with standard	EN-VDE
Nominal current I_N	6 A
Insulating material	LCP
Flammability rating according to UL 94	V0
Color	black
Number of positions	2

Standards and Regulations

Connection in acc. with standard	EN-VDE
Flammability rating according to UL 94	V0

Drawings

Drilling diagram

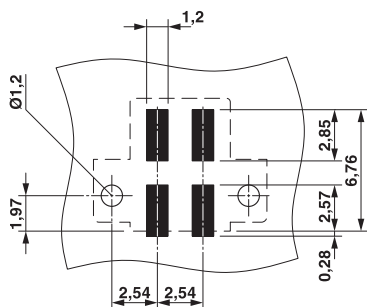

Diagram

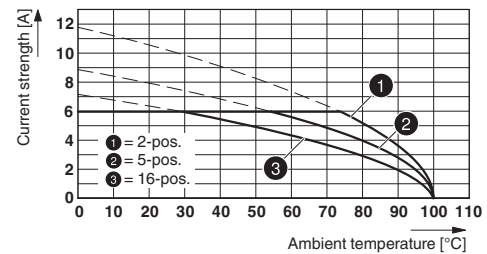

Type: DFMC 0,5/...-ST-2,54 with DMCV 0,5/...-G1-2,54 SMD R...

Printed-circuit board connector - DMCV 0,5/ 2-G1-2,54 SMD R32 - 1845179

Dimensional drawing

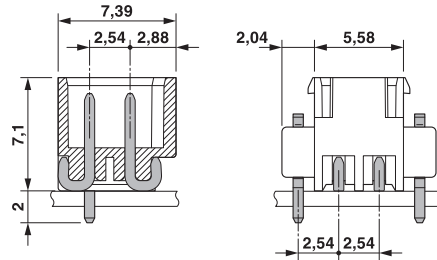

Classifications

eCl@ss

eCl@ss 5.1	27260701
eCl@ss 6.0	27260704
eCl@ss 8.0	27440402
eCl@ss 9.0	27440402

ETIM

ETIM 4.0	EC002637
ETIM 5.0	EC002637

Approvals

Approvals

Approvals

cULus Recognized / VDE Gutachten mit Fertigungsüberwachung / IECCEB Scheme / EAC

Ex Approvals

Approval details

cULus Recognized http://database.ul.com/cgi-bin/XYV/template/LISEXT/1FRAME/index.htm E60425-19920306		
	B	C
Nominal current I _N	6 A	6 A
Nominal voltage U _N	150 V	50 V

Printed-circuit board connector - DMCV 0,5/ 2-G1-2,54 SMD R32 - 1845179

Approvals

VDE Gutachten mit Fertigungsüberwachung  http://www.vde.de 40042389	
Nominal current IN	6 A
Nominal voltage UN	160 V

IECEE CB Scheme  http://www.iecee.org/ DE1-55740	
Nominal current IN	6 A
Nominal voltage UN	160 V

EAC B.01742

Accessories

Accessories

Labeled terminal marker

Marker card - SK 2,54/2,8:FORTL.ZAHLEN - 0804853



Marker card, Card, white, labeled, Horizontal: Consecutive numbers 1 - 10, 11 - 20, etc. up to 91 - 99, Mounting type: Adhesive, for terminal block width: 2.54 mm, Lettering field: 2.54 x 2.8 mm

Sample set - SAMPLE DMCV 0,5/ 2-G1-2,54 SMD - 1859945



Header, Nominal current: 6 A, Rated voltage (III/2): 160 V, Number of positions: 2, Pitch: 2.54 mm, Color: black, Contact surface: Gold, Mounting: SMD soldering

Additional products

Printed-circuit board connector - DMCV 0,5/ 2-G1-2,54 SMD R32 - 1845179

Accessories

Printed-circuit board connector - DFMC 0,5/ 2-ST-2,54 - 1844578

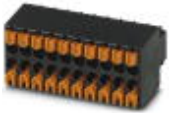

Plug, nominal current: 6 A, rated voltage (III/2): 160 V, number of positions: 2 with 4 contacts, pitch: 2.54 mm, connection method: spring connection, color: black, contact surface: gold