

SPECIFICATION

- Part No. : **DSGP.1575.12.4.A.02**
- Description : GPS L1 / GALILEO E1 1575MHz 12*12*4mm
Ceramic Patch SMT Antenna
- Features : 2.73 dBi Peak Gain for GPS/GALILEO Band
Dims: 12*12*4mm
SMT Direct Mount Ceramic Patch Antenna
Automotive TS16949 Approved
RoHS compliant

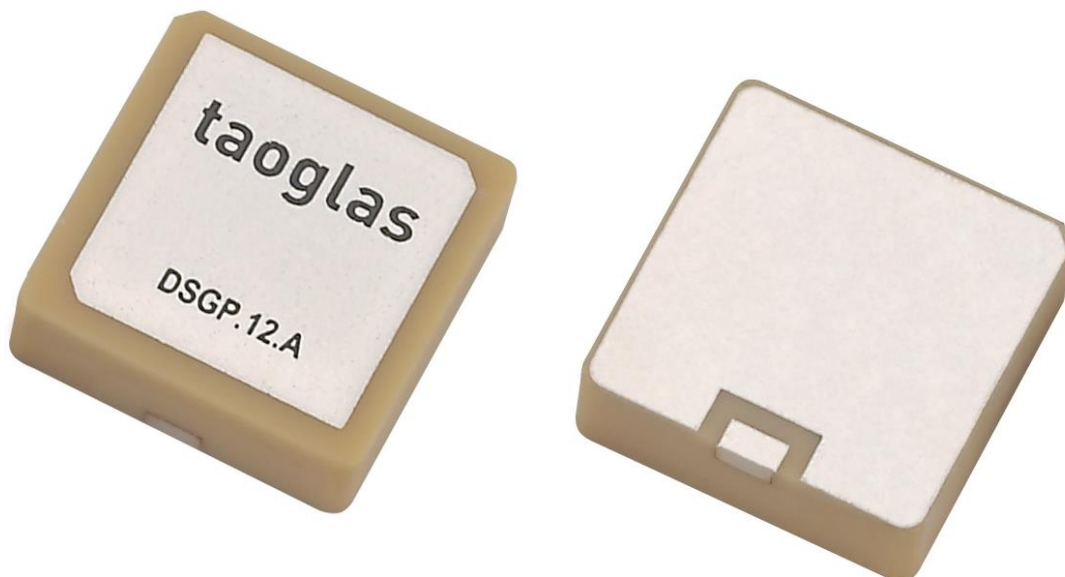

1. Introduction

The DSGP.1575.12.4.A.02 is a ceramic GPS L1 / GALILEO E1 passive patch antenna. 12mm square and with a height of just 4mm, this antenna is perfect for applications in compact telematics devices, vehicle tracking/fleet management systems, wearables and navigation devices.

The antenna has been tuned on a 50*50mm ground plane, working at 1575.42MHz with a 2.73dBi gain. The ceramic patch is mounted via SMT process, suitable for high volume low cost assembly.

The antenna is manufactured and tested in a TS16949 first tier automotive approved facility.

Small antennas should ideally be custom tuned for the device environment , Taoglas offers this service subject to NRE and MOQ. For more details please contact your regional Taoglas sales office.

2. Specification

ELECTRICAL	
Application Bands	GPS/GALILEO
Operation Frequency	1575.42 ±1.023MHz
Return Loss	< -10dB @ Center Frequency
Gain at Zenith	2.73dBi
Efficiency	62.36%
Impedance	50 ohms
MECHANICAL	
Ceramic Dimension	12*12*4mm
Weight	3.3g
ENVIRONMENTAL	
Operation Temperature	-40°C to 85°C
Humidity	Non-condensing 65°C 95% RH

* Antenna properties were measured with the antenna mounted on 50*50mm Ground Plane
Taoglas Part # DSGPD.12A

3. Antenna Characteristics

3.1. Return Loss

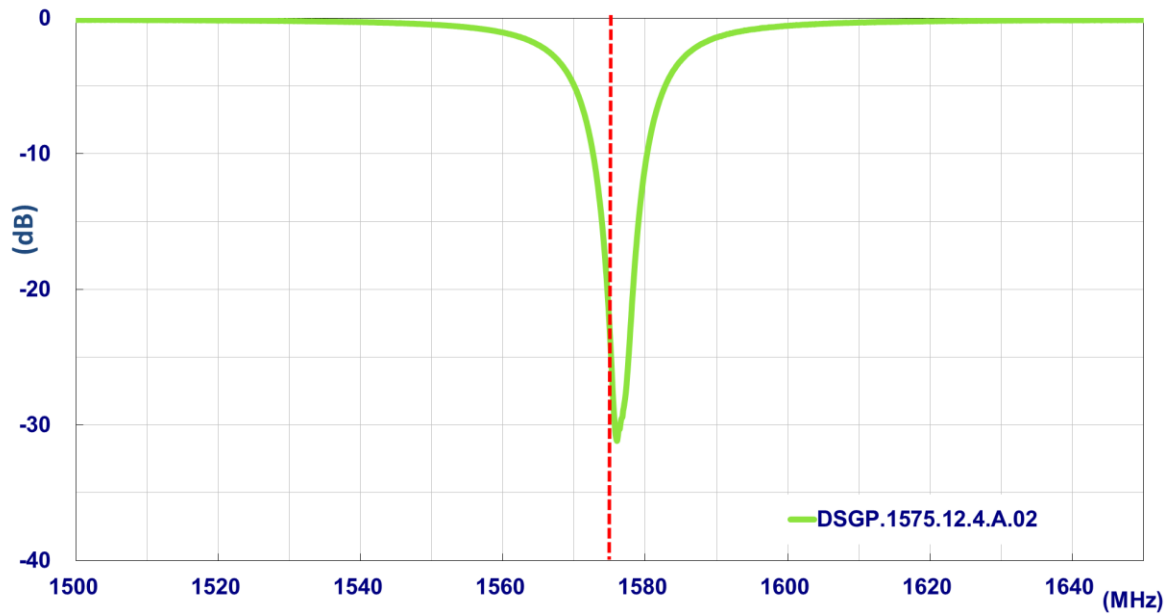

3.2. Efficiency

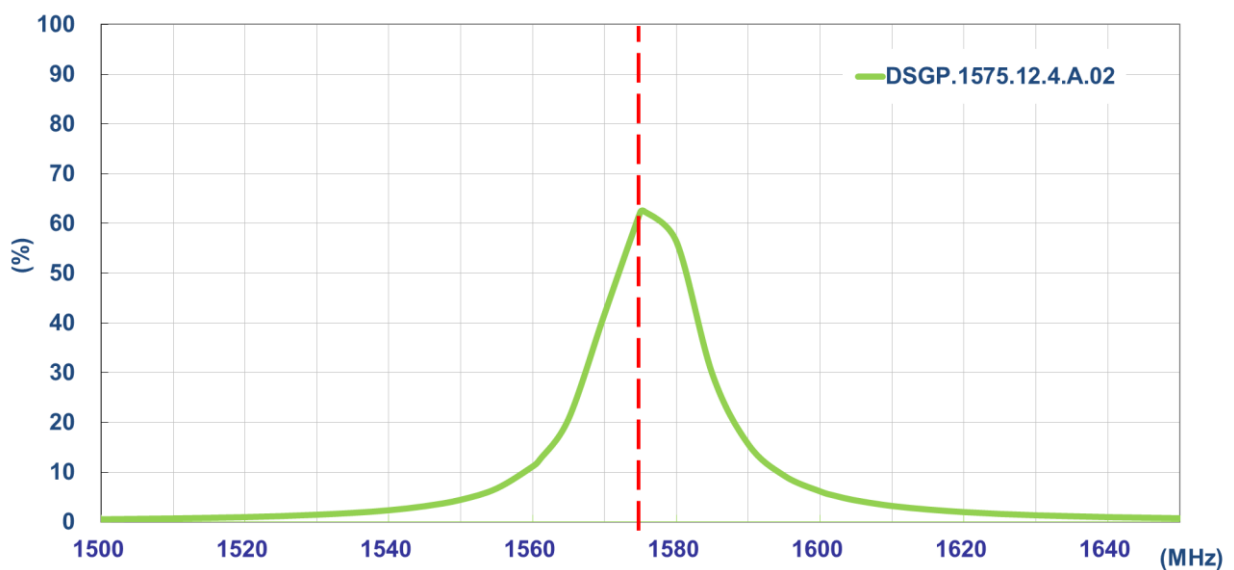

3.3. Average Gain

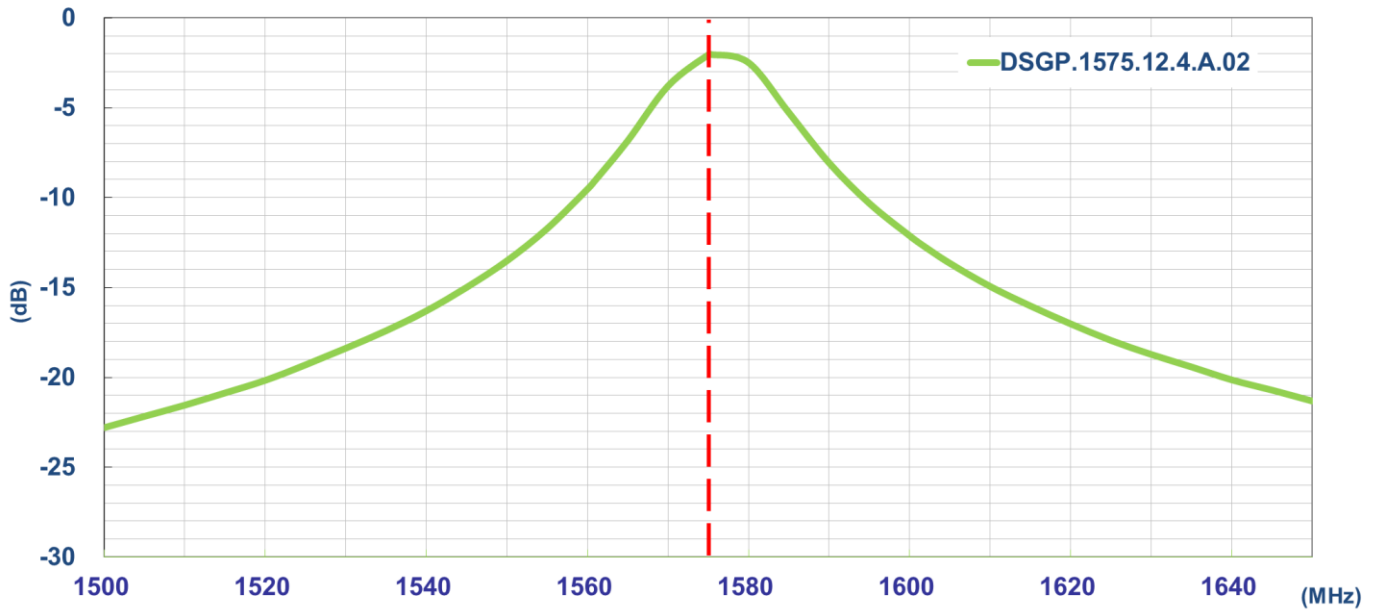

3.4. Peak Gain

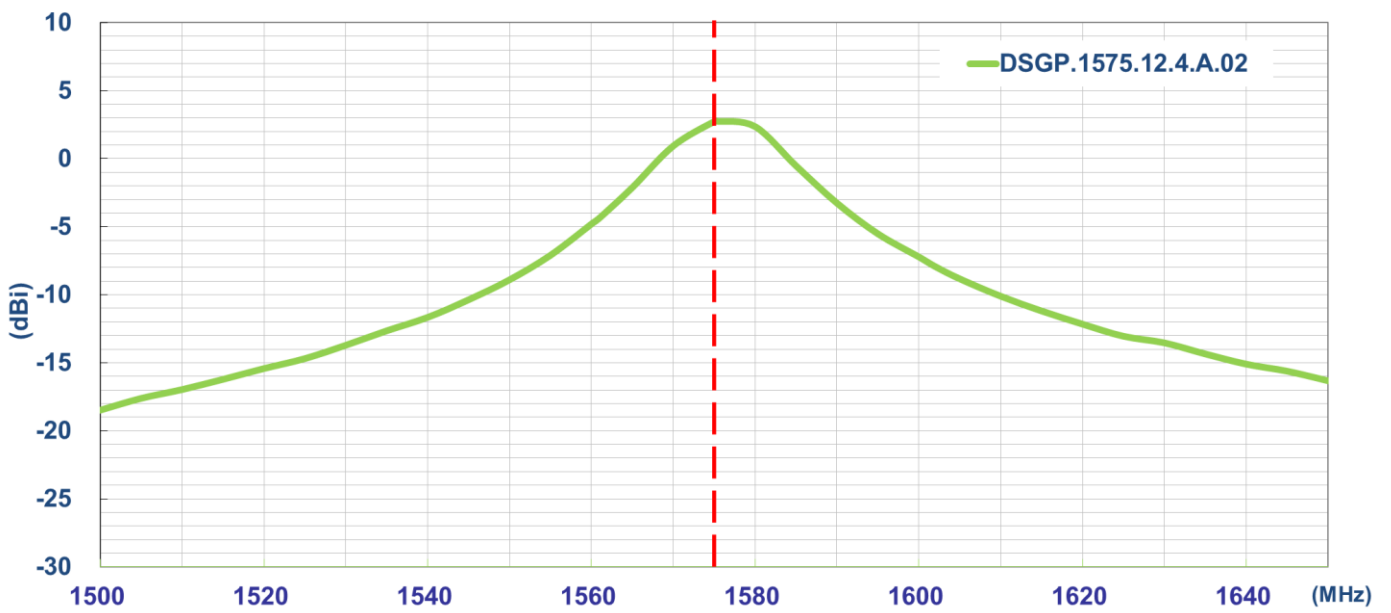

4. Antenna Radiation Pattern

4.1. Measurement Setup

The DSGP.1575.12.4 antenna is tested with 50*50mm ground plane in a CTIA certified ETS-Lindgren Anechoic Chamber. The test setup is shown below.

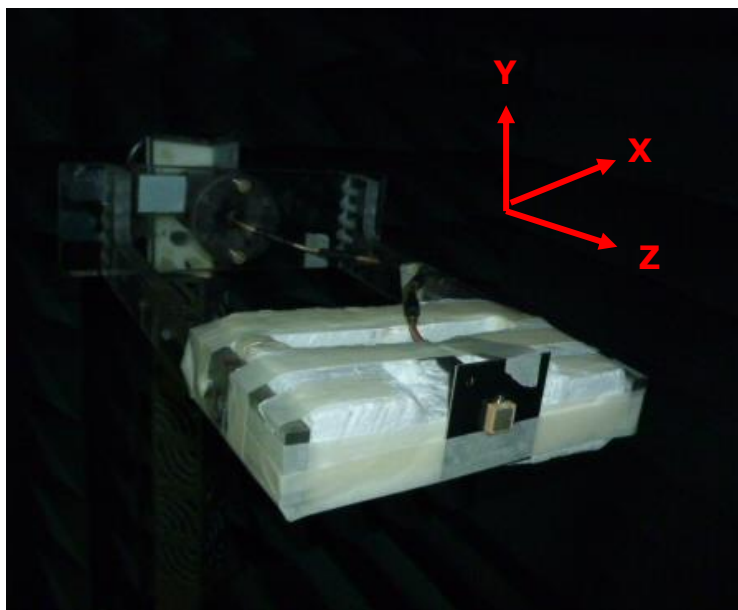

4.2. 2D Radiation Pattern

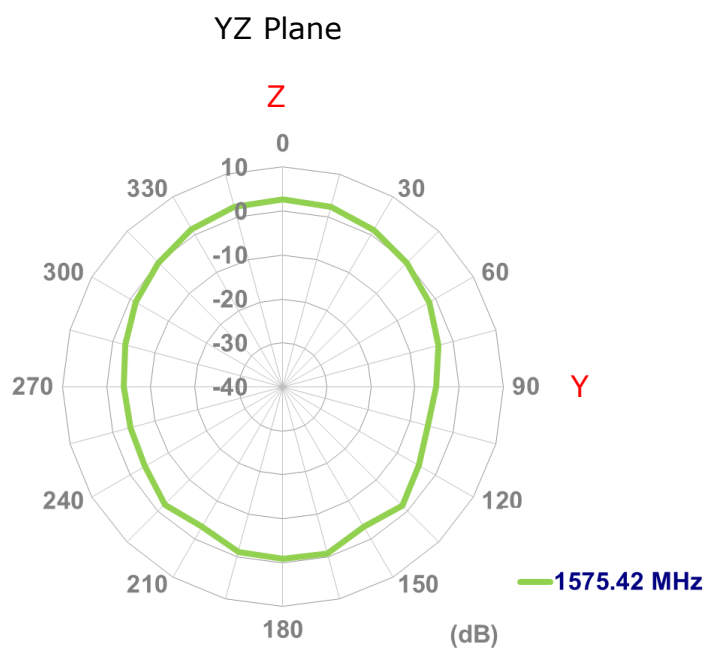
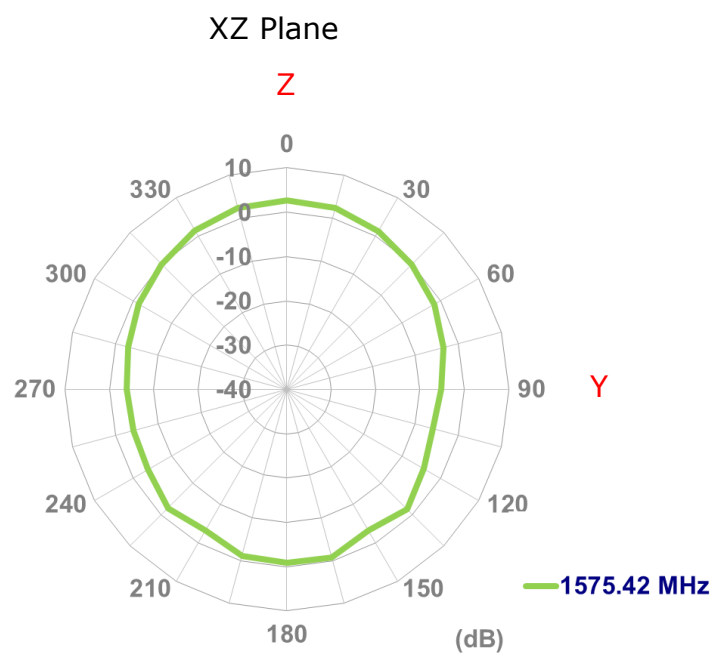
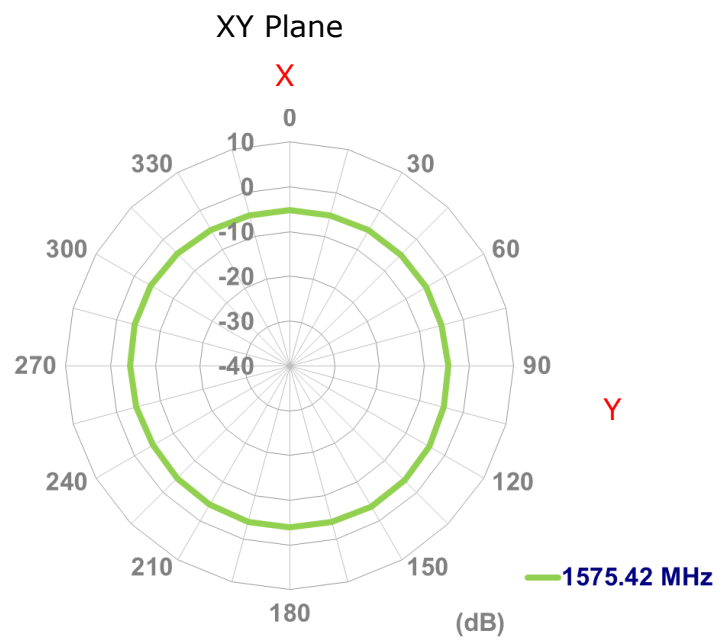

4.3. 3D Radiation Pattern

1575.42MHz

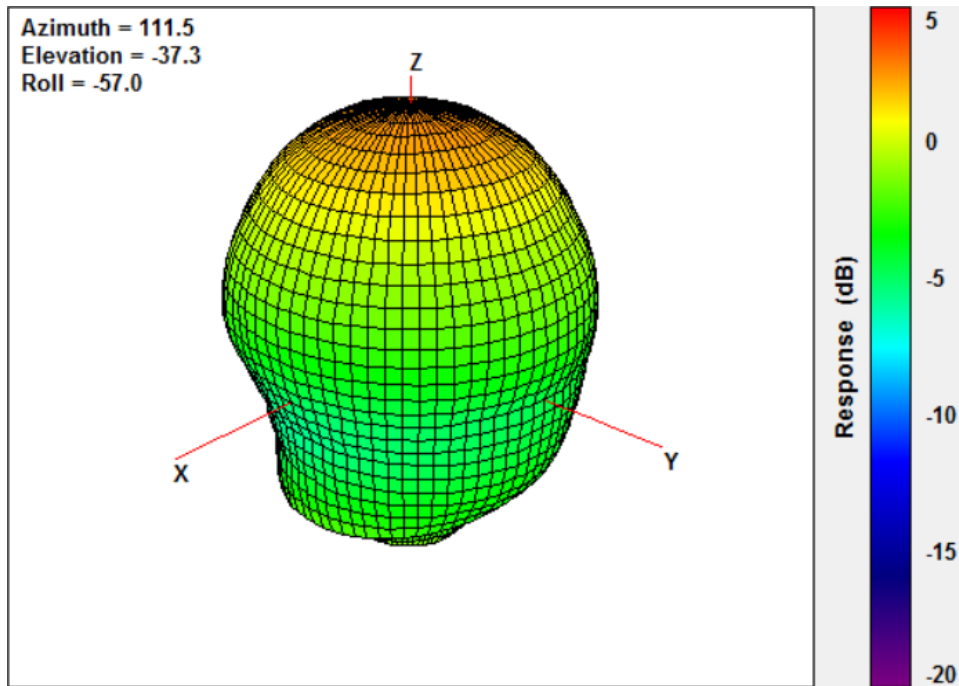

5. Mechanical Drawing (Unit: mm)

Top View

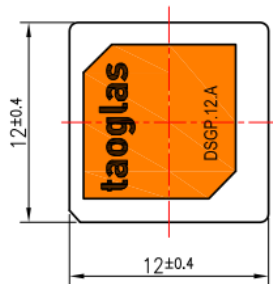

Side View



Bottom View

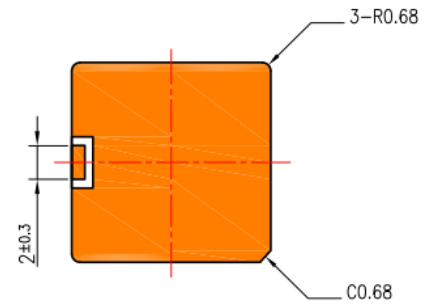

6. Evaluation Board DSGPD.12A (Unit: mm)

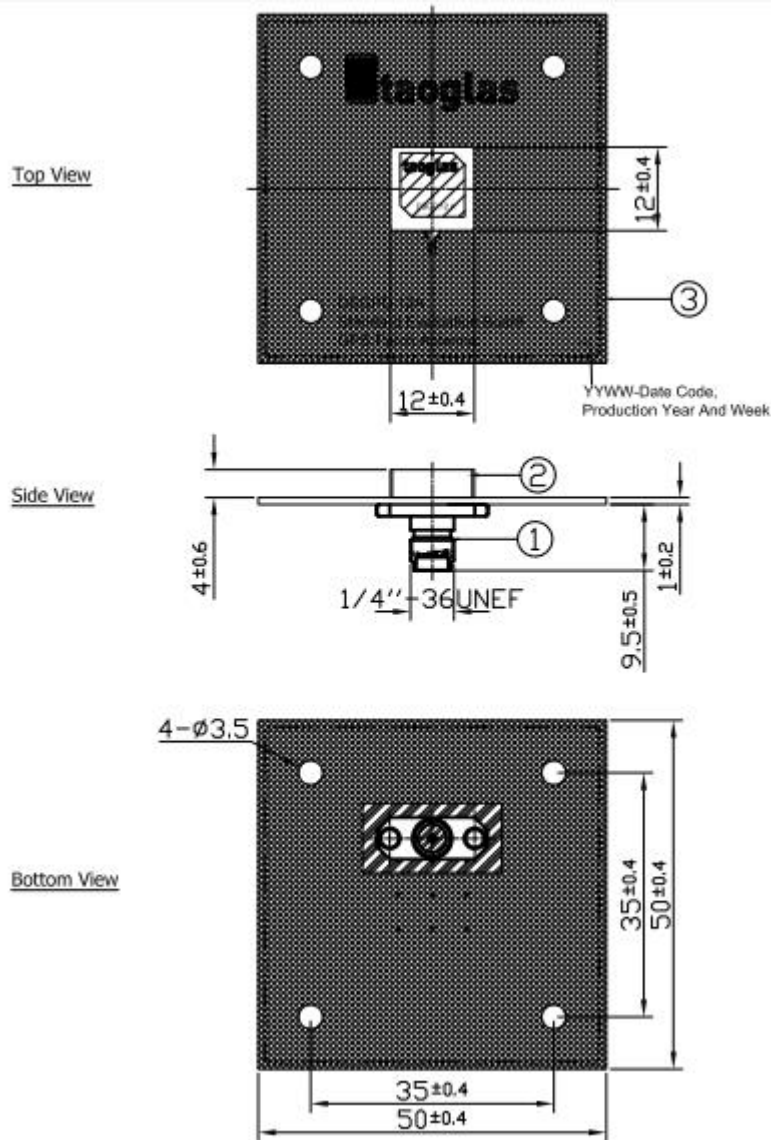

	Name	Material	Finish	QTY
1	PCB SMA(F) ST	Brass	Gold	1
2	DSGP.1575.12.4.A.02 Antenna	Ceramic	Clear	1
3	PCB (50x50x1mm)	FR4 1.0t	Black	1

7. PCB Footprint Recommendation



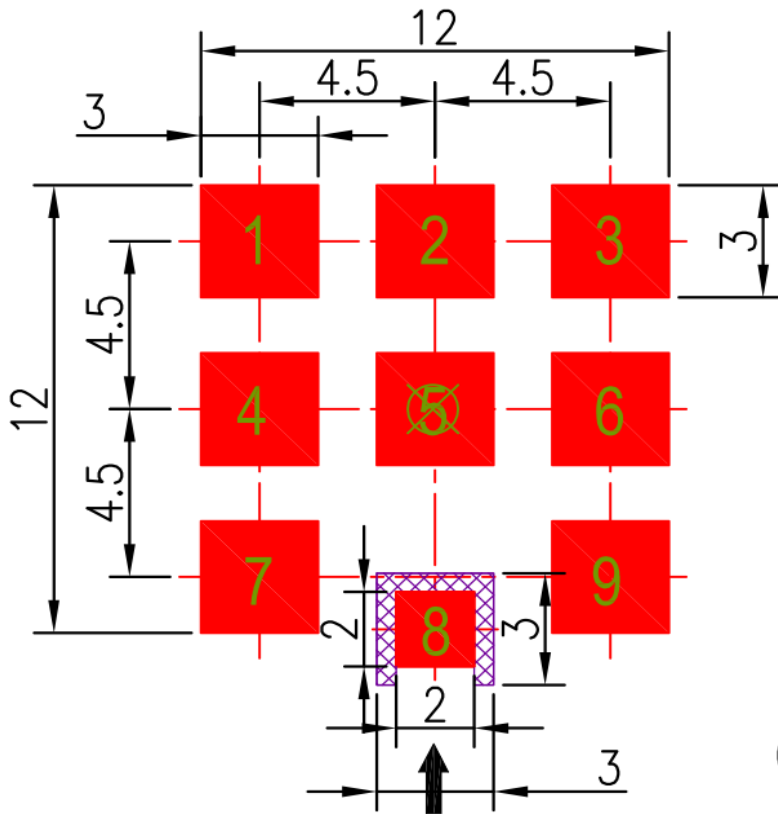

7.1. Footprint Copper Keepout Area (Unit: mm)

Pads 1, 2, 3, 4, 5, 6, 7 and 9 are the same size. They should be connected to GND



→ :
Connected to 50 ohm
transmission line.

NOTE:



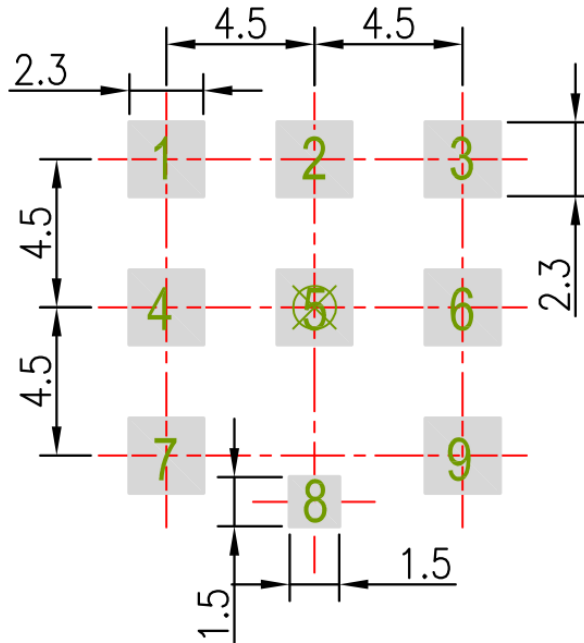

1. Ag Plated area 
2. Solder Mask area 
3. Copper area 
4. Paste area 
5. Copper Keepout Area 
6. Copper keepout should extend through all PCB layers.
7. Any vias in pads should be either filled or tented to prevent solder from wicking away from the pad during reflow.
8. The dimension tolerances should follow standard PCB manufacturing guidelines

7.2. Paste Area (Unit: mm)

Pads 1, 2, 3, 4, 5, 6, 7 and 9 are the same size.



NOTE:



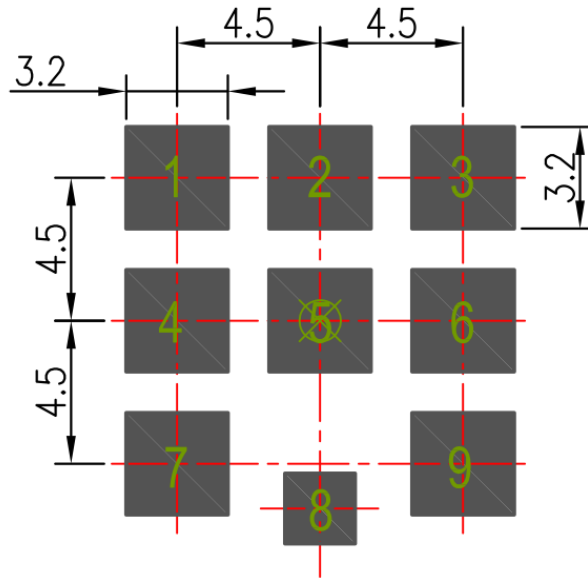

- 1. Ag Plated area 
- 2. Solder Mask area 
- 3. Copper area 
- 4. Paste area 
- 5. Copper Keepout Area 
- 6. Copper keepout should extend through all PCB layers.
- 7. Any vias in pads should be either filled or tented to prevent solder from wicking away from the pad during reflow.
- 8. The dimension tolerances should follow standard PCB manufacturing guidelines

7.3. Top Solder Mask (Unit: mm)

Pads 1, 2, 3, 4, 5, 6, 7 and 9 are the same size. This drawing is a negative of solder mask. Black regions are anti-mask.





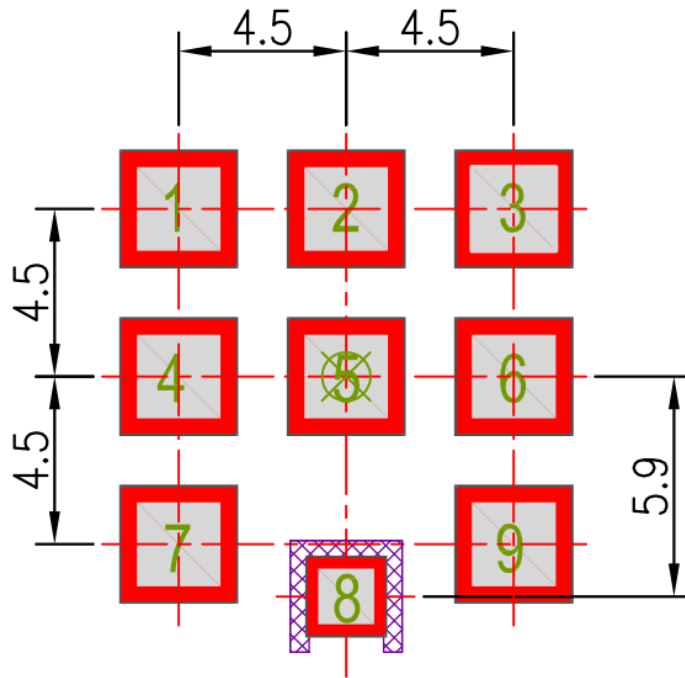

NOTE:

- 1. Ag Plated area 
- 2. Solder Mask area 
- 3. Copper area 
- 4. Paste area 
- 5. Copper Keepout Area 
- 6. Copper keepout should extend through all PCB layers.
- 7. Any vias in pads should be either filled or tented to prevent solder from wicking away from the pad during reflow.
- 8. The dimension tolerances should follow standard PCB manufacturing guidelines

7.4. Composite Diagram (Unit: mm)



NOTE:

- 1. Ag Plated area 
- 2. Solder Mask area 
- 3. Copper area 
- 4. Paste area 
- 5. Copper Keepout Area 
- 6. Copper keepout should extend through all PCB layers.
- 7. Any vias in pads should be either filled or tented to prevent solder from wicking away from the pad during reflow.
- 8. The dimension tolerances should follow standard PCB manufacturing guidelines

8. Recommended Reflow Soldering Profile

DSGP.12 can be assembled following Pb-free assembly. According to the Standard IPC/JEDEC J-STD-020C, the temperature profile suggested is as follows:

Phase	Profile Features	Pb-Free Assembly (SnAgCu)
PREHEAT	Temperature Min(T_{smin}) Temperature Max(T_{smax}) Time(t_s) from (T_{smin} to T_{smax})	150°C 200°C 60-120 seconds
RAMP-UP	Avg. Ramp-up Rate (T_{smax} to T_P)	3°C/second(max)
REFLOW	Temperature(T_L) Total Time above T_L (t_L)	217°C 30-100 seconds
PEAK	Temperature(T_P) Time(t_p)	260°C 2-5 seconds
RAMP-DOWN	Rate	3°C/second(max)
Time from 25°C to Peak Temperature		8 minutes max.
Composition of solder paste		96.5Sn/3Ag/0.5Cu
Solder Paste Model		SHENMAO PF606-P26

The graphic shows temperature profile for component assembly process in reflow ovens

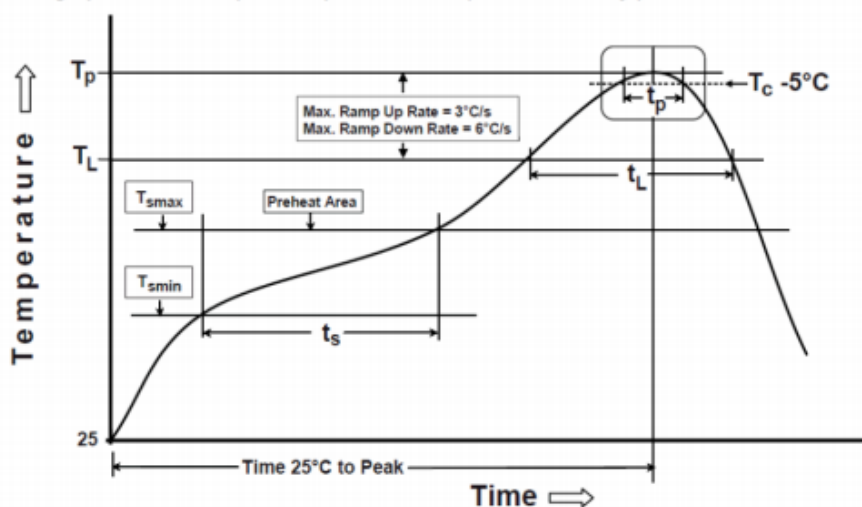

Soldering Iron condition: Soldering iron temperature $270^{\circ}\text{C} \pm 10^{\circ}\text{C}$.

Apply preheating at 120°C for 2-3 minutes. Finish soldering for each terminal within 3 seconds, if soldering iron temperature over $270^{\circ}\text{C} \pm 10^{\circ}\text{C}$ or 3 seconds, it will make cause component surface peeling or damage.

9. Packaging

9.1. Inner Tray

500 pc DSGP.1575.12.4.A.02 per reel
 Dimensions - Ø335*40mm
 Weight - 1.86Kg

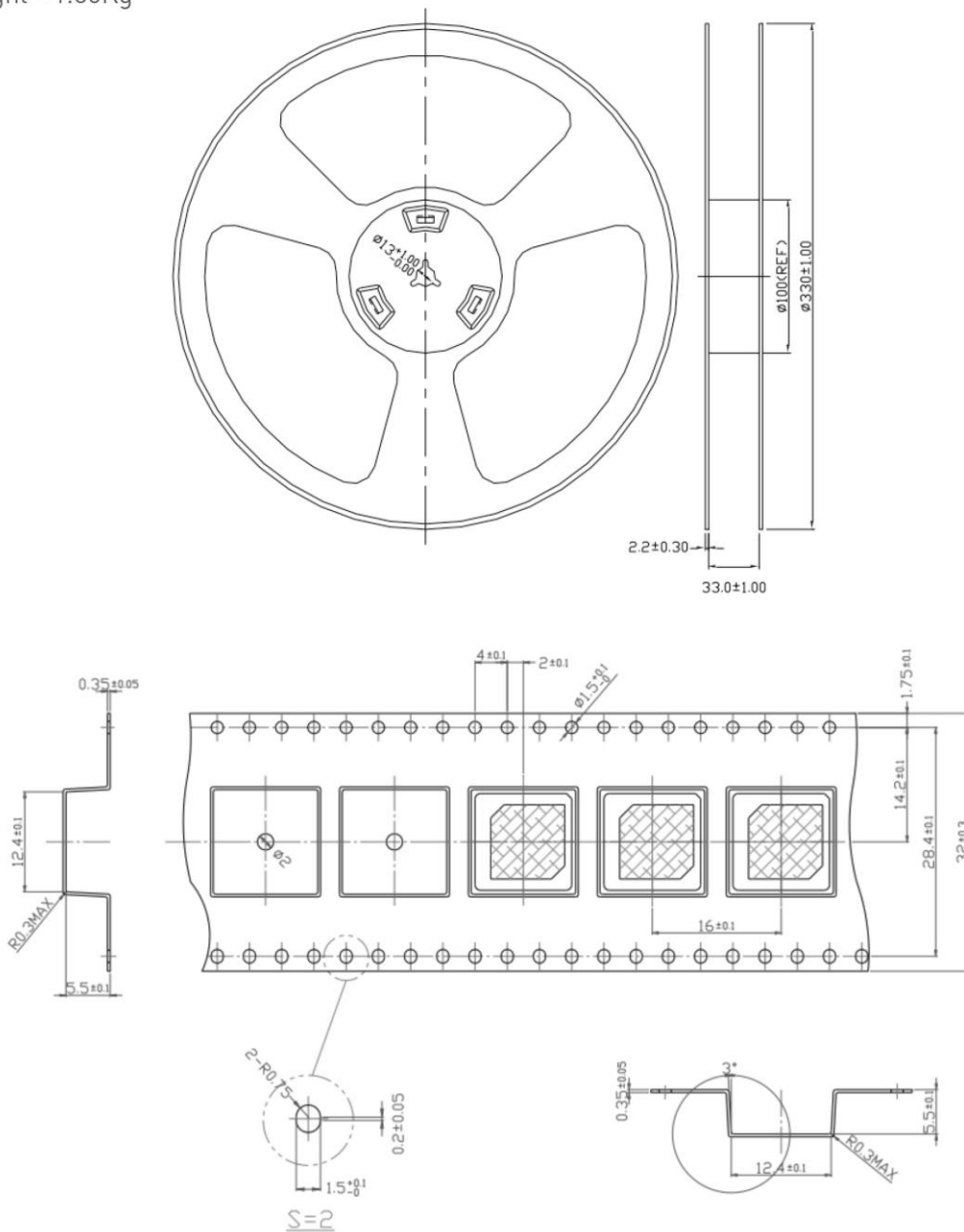

1 pc reel in small inner box
Dimensions - 350*340*70mm
Weight - 2.0Kg

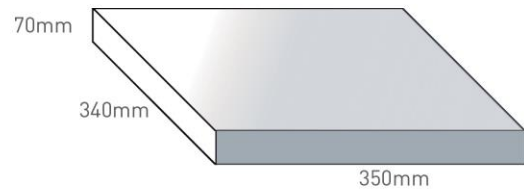

4 Reels / 2000 pcs in one carton
Carton Dimensions - 370*370*300mm
Weight - 7.94Kg

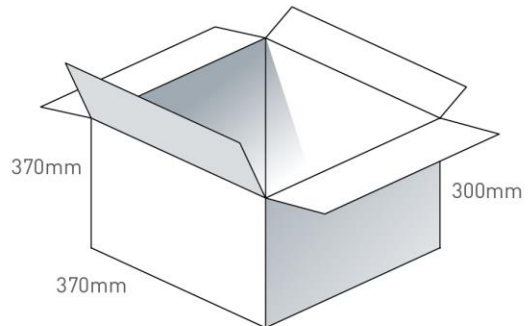

Pallet Dimensions 1100*1100*1270mm
36 Cartons per Pallet
9 Cartons per layer
4 Layers

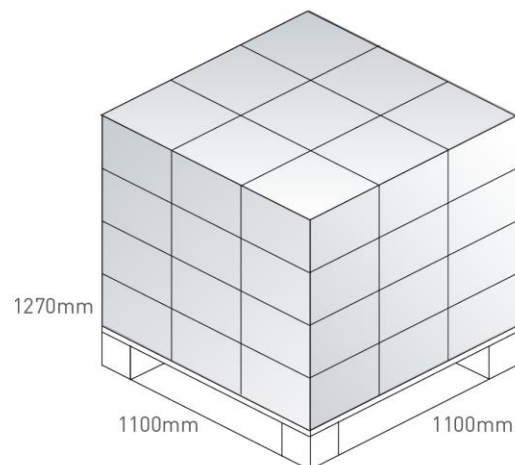

Taoglas makes no warranties based on the accuracy or completeness of the contents of this document and reserves the right to make changes to specifications and product descriptions at any time without notice. Taoglas reserves all rights to this document and the information contained herein.

Reproduction, use or disclosure to third parties without express permission is strictly prohibited.

Copyright © Taoglas Ltd.