

HighSpeed 2-Technology with soft, fast recovery anti-parallel EmCon HE diode

- **Designed for:**
 - TV – Horizontal Line Deflection
- **2nd generation HighSpeed-Technology for 1200V applications offers:**
 - loss reduction in resonant circuits
 - temperature stable behavior
 - parallel switching capability
 - tight parameter distribution
 - Integrated anti-parallel diode
 - E_{off} optimized for $I_C = 3A$

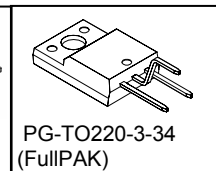
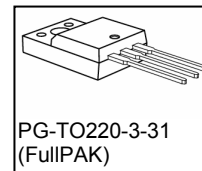
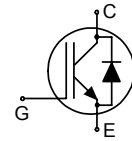

- Qualified according to JEDEC² for target applications
- Pb-free lead plating; RoHS compliant
- Complete product spectrum and PSpice Models : <http://www.infineon.com/igbt/>

Type	V_{CE}	I_C	E_{off}	T_j	Marking	Package
IKA03N120H2	1200V	3A	0.15mJ	150°C	K03H1202	PG-TO-220-3-31
IKA03N120H2	1200V	3A	0.15mJ	150°C	K03H1202	PG-TO-220-3-34

Maximum Ratings

Parameter	Symbol	Value	Unit
Collector-emitter voltage	V_{CE}	1200	V
Triangular collector peak current ($V_{GE} = 15V$) $T_C = 100^\circ C, f = 32kHz$	I_C	8.2	A
Pulsed collector current, t_p limited by T_{jmax}	I_{Cpuls}	9	
Turn off safe operating area $V_{CE} \leq 1200V, T_j \leq 150^\circ C$	-	9	
Diode forward current $T_C = 25^\circ C$ $T_C = 100^\circ C$	I_F	9.6 3.9	
Gate-emitter voltage	V_{GE}	± 20	V
Power dissipation $T_C = 25^\circ C$	P_{tot}	29	W
Operating junction and storage temperature	T_j, T_{stg}	-40...+150	°C
Soldering temperature, 1.6mm (0.063 in.) from case for 10s	-	260	
Isolation Voltage	V_{isol}	2500	V_{rms}

² J-STD-020 and JESD-022

Thermal Resistance

Parameter	Symbol	Conditions	Max. Value	Unit
Characteristic				
IGBT thermal resistance, junction – case	R_{thJC}		4.3	K/W
Diode thermal resistance, junction - case	R_{thJCD}		5.8	
Thermal resistance, junction – ambient	R_{thJA}		62	

Electrical Characteristic, at $T_j = 25^\circ\text{C}$, unless otherwise specified

Parameter	Symbol	Conditions	Value			Unit
			min.	Typ.	max.	
Static Characteristic						
Collector-emitter breakdown voltage	$V_{(BR)CES}$	$V_{GE}=0V, I_C=300\mu A$	1200	-	-	V
Collector-emitter saturation voltage	$V_{CE(sat)}$	$V_{GE} = 15V, I_C=3A$	-	2.2	2.8	
		$T_j=25^\circ\text{C}$	-	2.5	-	
		$T_j=150^\circ\text{C}$	-	2.4	-	
Diode forward voltage	V_F	$V_{GE} = 0, I_F=3A$	-	1.55	-	
		$T_j=25^\circ\text{C}$	-	1.6	-	
		$T_j=150^\circ\text{C}$	-	-	-	
Gate-emitter threshold voltage	$V_{GE(th)}$	$I_C=90\mu A, V_{CE}=V_{GE}$	2.1	3	3.9	
Zero gate voltage collector current	I_{CES}	$V_{CE}=1200V, V_{GE}=0V$	-	-	20	μA
		$T_j=25^\circ\text{C}$	-	-	80	
		$T_j=150^\circ\text{C}$	-	-	-	
Gate-emitter leakage current	I_{GES}	$V_{CE}=0V, V_{GE}=20V$	-	-	100	nA
Transconductance	g_{fs}	$V_{CE}=20V, I_C=3A$	-	2	-	S
Dynamic Characteristic						
Input capacitance	C_{iss}	$V_{CE}=25V,$	-	205	-	pF
Output capacitance	C_{oss}	$V_{GE}=0V,$	-	24	-	
Reverse transfer capacitance	C_{riss}	$f=1\text{MHz}$	-	7	-	
Gate charge	Q_{Gate}	$V_{CC}=960V, I_C=3A$ $V_{GE}=15V$	-	8.6	-	nC
Internal emitter inductance measured 5mm (0.197 in.) from case	L_E		-	7	-	nH

Switching Characteristic, Inductive Load, at $T_j=25^\circ\text{C}$

Parameter	Symbol	Conditions	Value			Unit
			min.	typ.	max.	
IGBT Characteristic						
Turn-on delay time	$t_{d(on)}$	$T_j=25^\circ\text{C}$, $V_{CC}=800\text{V}$, $I_C=3\text{A}$, $V_{GE}=0\text{V}/15\text{V}$, $R_G=82\Omega$, $L_\sigma^{(2)}=180\text{nH}$, $C_\sigma^{(2)}=40\text{pF}$ Energy losses include "tail" and diode ³⁾ reverse recovery.	-	9.2	-	ns
Rise time	t_r		-	5.2	-	
Turn-off delay time	$t_{d(off)}$		-	281	-	
Fall time	t_f		-	29	-	
Turn-on energy	E_{on}		-	0.14	-	mJ
Turn-off energy	E_{off}		-	0.15	-	
Total switching energy	E_{ts}		-	0.29	-	
Anti-Parallel Diode Characteristic						
Diode reverse recovery time	t_{rr}	$T_j=25^\circ\text{C}$, $V_R=800\text{V}$, $I_F=3\text{A}$, $R_G=82\Omega$	-	52	-	ns
Diode reverse recovery charge	Q_{rr}		-	0.23	-	μC
Diode peak reverse recovery current	I_{rrm}		-	9.3	-	A
Diode current slope	di_F/dt		-	723	-	$\text{A}/\mu\text{s}$

Switching Characteristic, Inductive Load, at $T_j=150^\circ\text{C}$

Parameter	Symbol	Conditions	Value			Unit
			min.	typ.	max.	
IGBT Characteristic						
Turn-on delay time	$t_{d(on)}$	$T_j=150^\circ\text{C}$ $V_{CC}=800\text{V}$, $I_C=3\text{A}$, $V_{GE}=0\text{V}/15\text{V}$, $R_G=82\Omega$, $L_\sigma^{(2)}=180\text{nH}$, $C_\sigma^{(2)}=40\text{pF}$ Energy losses include "tail" and diode ³⁾ reverse recovery.	-	9.4	-	ns
Rise time	t_r		-	6.7	-	
Turn-off delay time	$t_{d(off)}$		-	340	-	
Fall time	t_f		-	63	-	
Turn-on energy	E_{on}		-	0.22	-	mJ
Turn-off energy	E_{off}		-	0.26	-	
Total switching energy	E_{ts}		-	0.48	-	
Anti-Parallel Diode Characteristic						
Diode reverse recovery time	t_{rr}	$T_j=150^\circ\text{C}$ $V_R=800\text{V}$, $I_F=3\text{A}$, $R_G=82\Omega$	-	112	-	ns
Diode reverse recovery charge	Q_{rr}		-	0.52	-	μC
Diode peak reverse recovery current	I_{rrm}		-	11	-	A
Diode current slope	di_F/dt		-	661	-	$\text{A}/\mu\text{s}$

²⁾ Leakage inductance L_σ and stray capacity C_σ due to dynamic test circuit in figure E

³⁾ Commutation diode from device IKP03N120H2

Switching Energy ZVT, Inductive Load

Parameter	Symbol	Conditions	Value			Unit
			min.	typ.	max.	
IGBT Characteristic						
Turn-off energy	E_{off}	$V_{CC}=800V, I_C=3A,$ $V_{GE}=0V/15V,$ $R_G=82\Omega, C_r^{2)}=4nF$ $T_j=25^\circ C$ $T_j=150^\circ C$	-	0.05	-	mJ
			-	0.09	-	

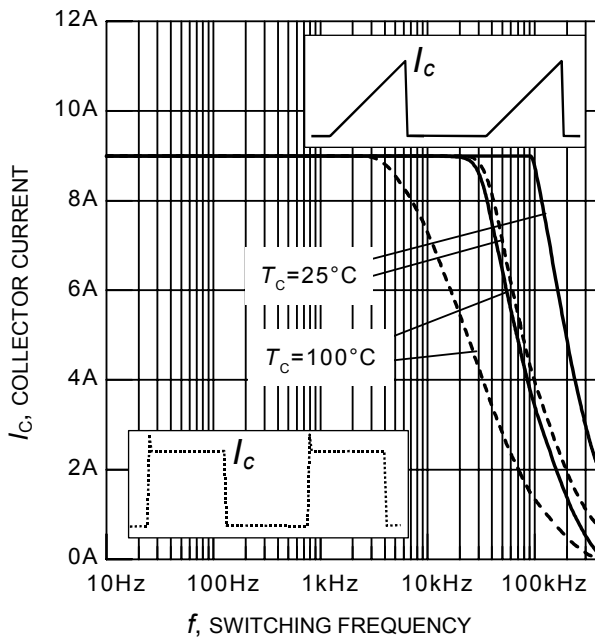

Figure 1. Collector current as a function of switching frequency
 ($T_j \leq 150^\circ\text{C}$, $D = 0.5$, $V_{CE} = 800\text{V}$, $V_{GE} = +15\text{V}/0\text{V}$, $R_G = 82\Omega$)

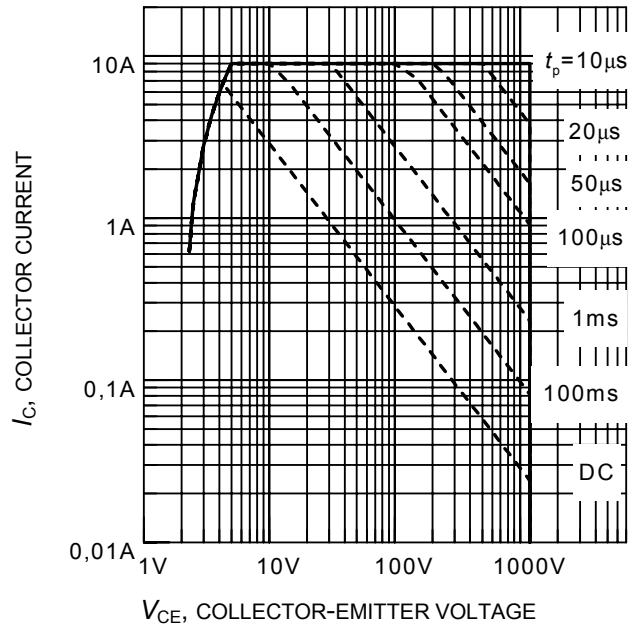

Figure 2. Safe operating area
 ($D = 0$, $T_C = 25^\circ\text{C}$, $T_j \leq 150^\circ\text{C}$)

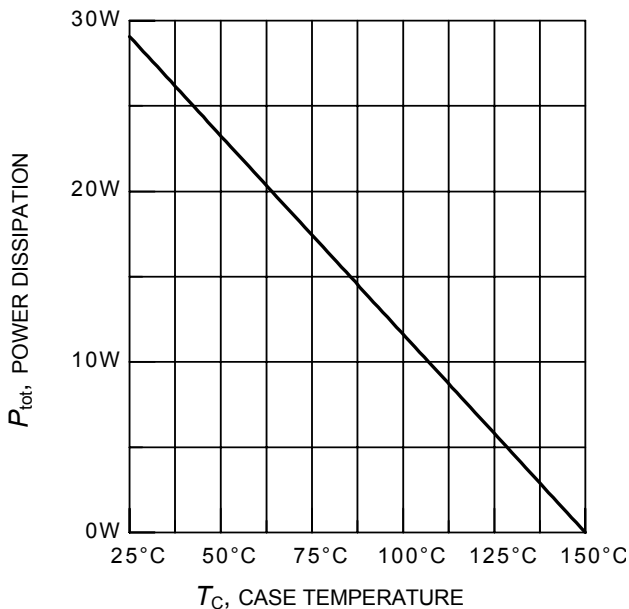

Figure 3. Power dissipation as a function of case temperature
 ($T_j \leq 150^\circ\text{C}$)

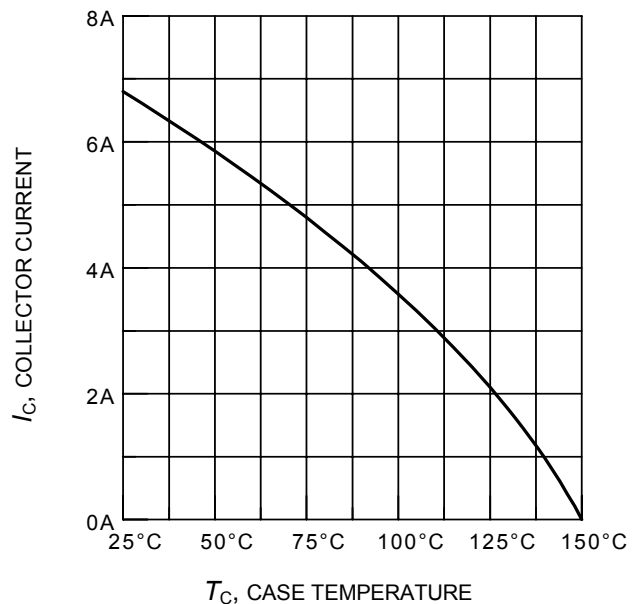

Figure 4. Collector current as a function of case temperature
 ($V_{GE} \leq 15\text{V}$, $T_j \leq 150^\circ\text{C}$)

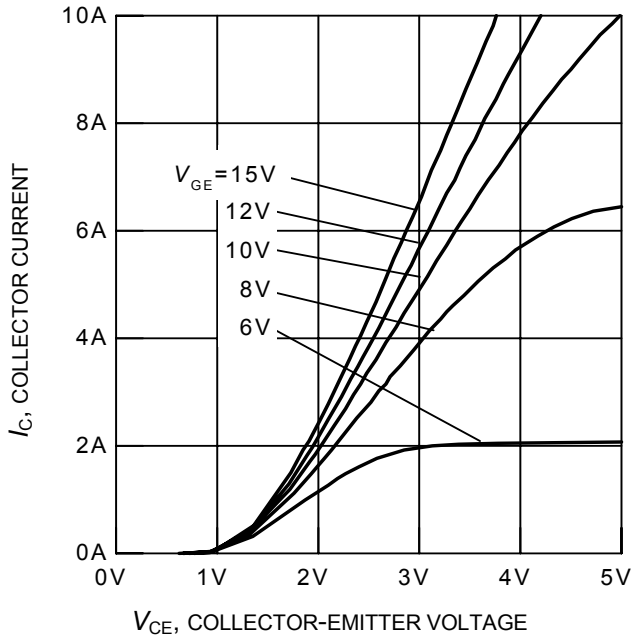

Figure 5. Typical output characteristics
($T_j = 25^\circ\text{C}$)

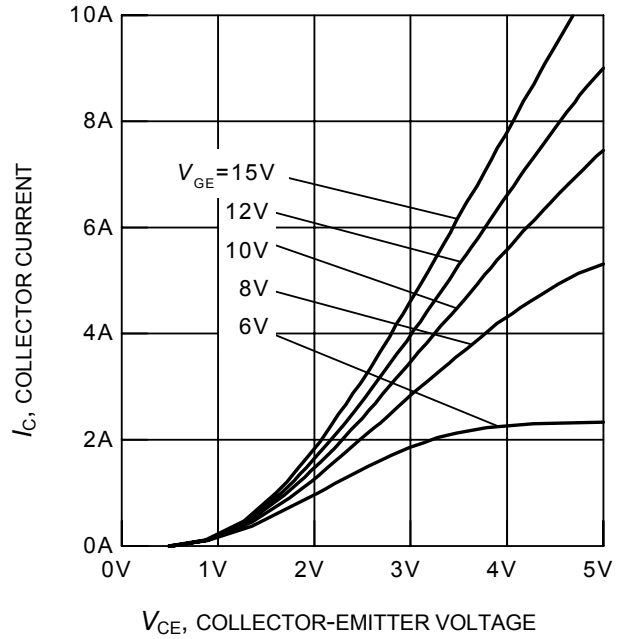

Figure 6. Typical output characteristics
($T_j = 150^\circ\text{C}$)

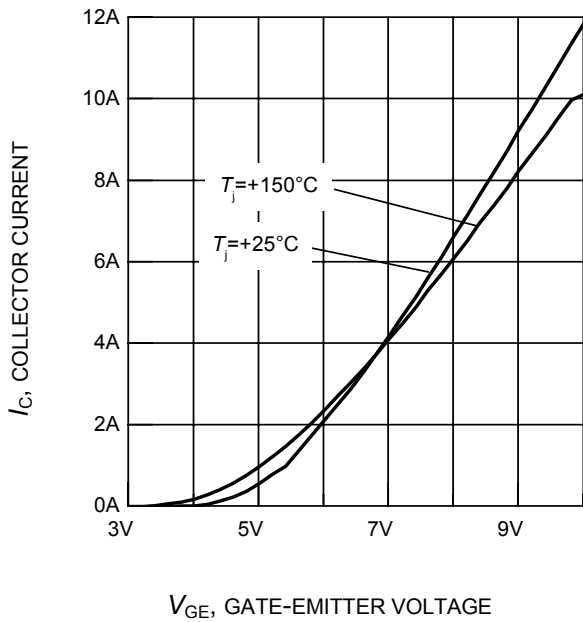

Figure 7. Typical transfer characteristics
($V_{CE} = 20\text{V}$)

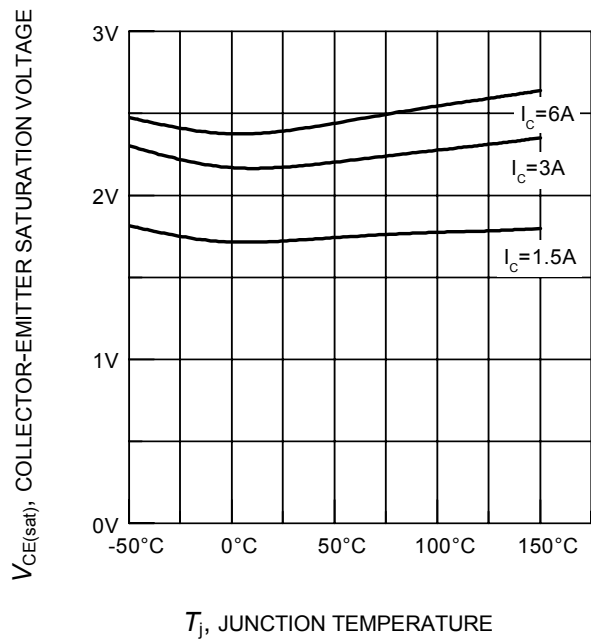
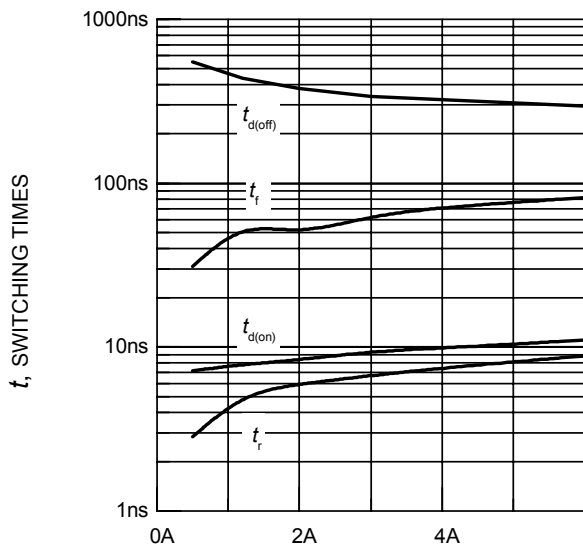

Figure 8. Typical collector-emitter saturation voltage as a function of junction temperature
($V_{GE} = 15\text{V}$)



I_C , COLLECTOR CURRENT

Figure 9. Typical switching times as a function of collector current

(inductive load, $T_j = 150^\circ\text{C}$, $V_{CE} = 800\text{V}$, $V_{GE} = +15\text{V}/0\text{V}$, $R_G = 82\Omega$, dynamic test circuit in Fig.E)

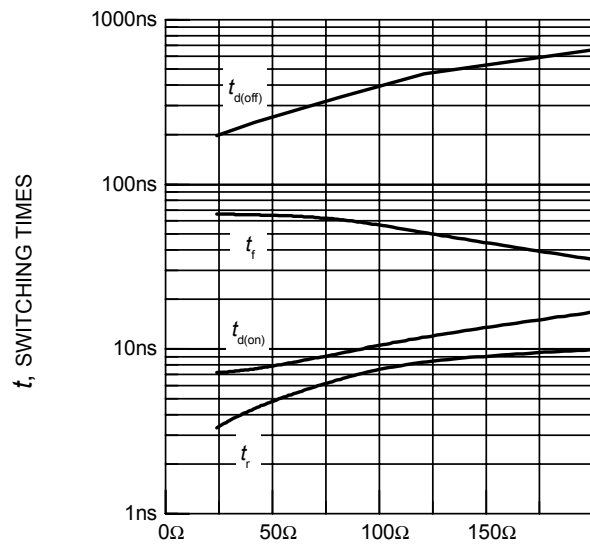

R_G , GATE RESISTOR

Figure 10. Typical switching times as a function of gate resistor

(inductive load, $T_j = 150^\circ\text{C}$, $V_{CE} = 800\text{V}$, $V_{GE} = +15\text{V}/0\text{V}$, $I_C = 3\text{A}$, dynamic test circuit in Fig.E)

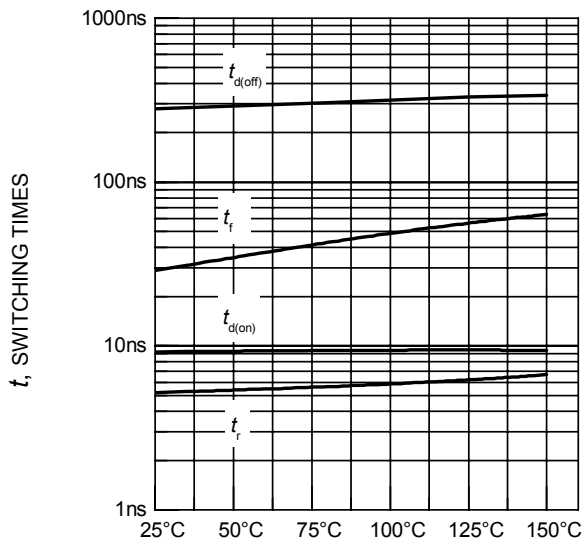

T_j , JUNCTION TEMPERATURE

Figure 11. Typical switching times as a function of junction temperature

(inductive load, $V_{CE} = 800\text{V}$, $V_{GE} = +15\text{V}/0\text{V}$, $I_C = 3\text{A}$, $R_G = 82\Omega$, dynamic test circuit in Fig.E)

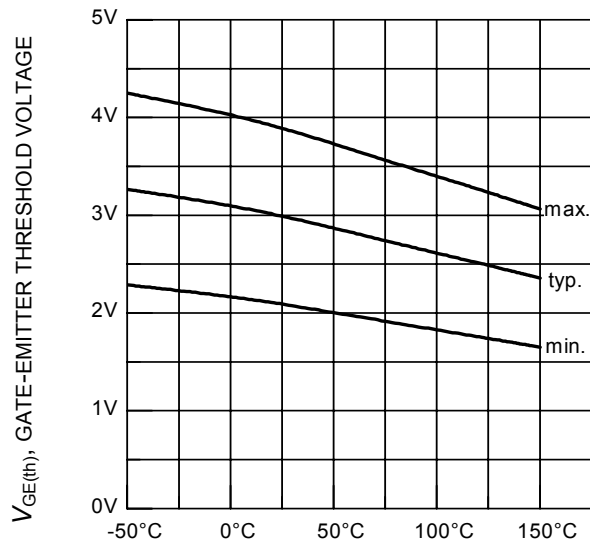

T_j , JUNCTION TEMPERATURE

Figure 12. Gate-emitter threshold voltage as a function of junction temperature

($I_C = 0.09\text{mA}$)

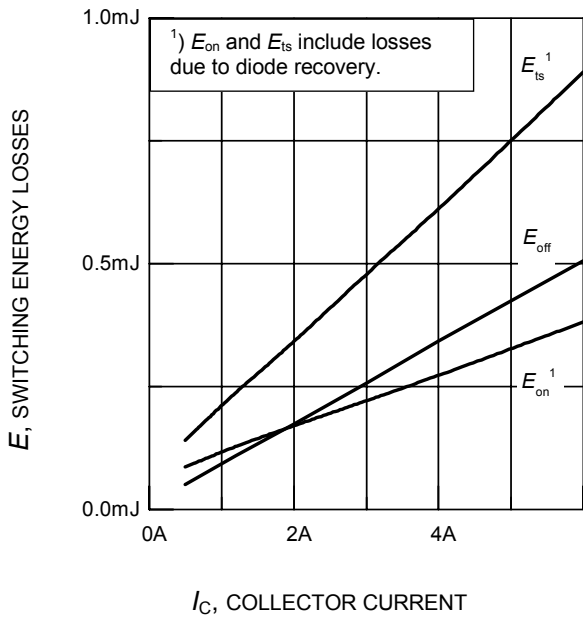

Figure 13. Typical switching energy losses as a function of collector current
 (inductive load, $T_j = 150^\circ\text{C}$, $V_{CE} = 800\text{V}$, $V_{GE} = +15\text{V}/0\text{V}$, $R_G = 82\Omega$, dynamic test circuit in Fig.E)

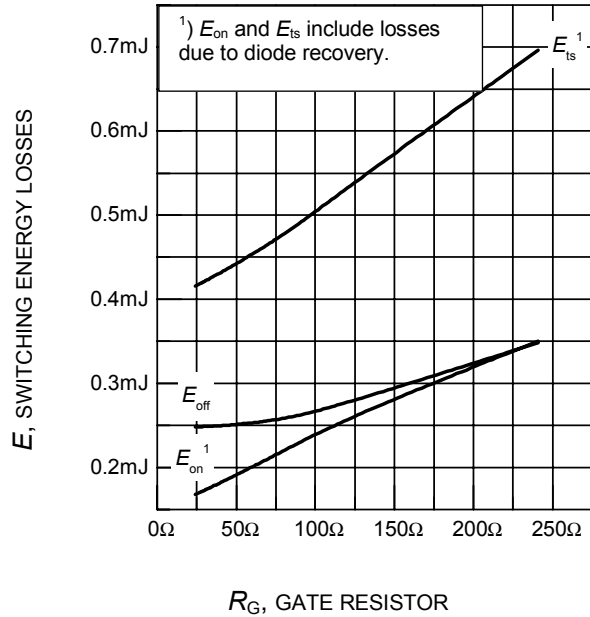

Figure 14. Typical switching energy losses as a function of gate resistor
 (inductive load, $T_j = 150^\circ\text{C}$, $V_{CE} = 800\text{V}$, $V_{GE} = +15\text{V}/0\text{V}$, $I_C = 3\text{A}$, dynamic test circuit in Fig.E)

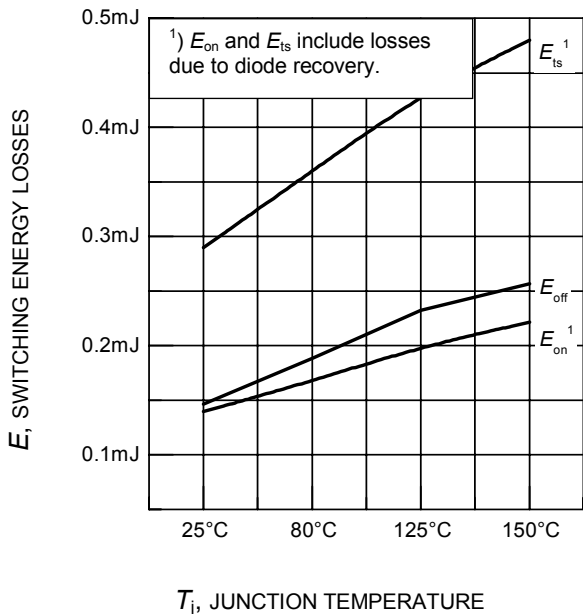

Figure 15. Typical switching energy losses as a function of junction temperature
 (inductive load, $V_{CE} = 800\text{V}$, $V_{GE} = +15\text{V}/0\text{V}$, $I_C = 3\text{A}$, $R_G = 82\Omega$, dynamic test circuit in Fig.E)

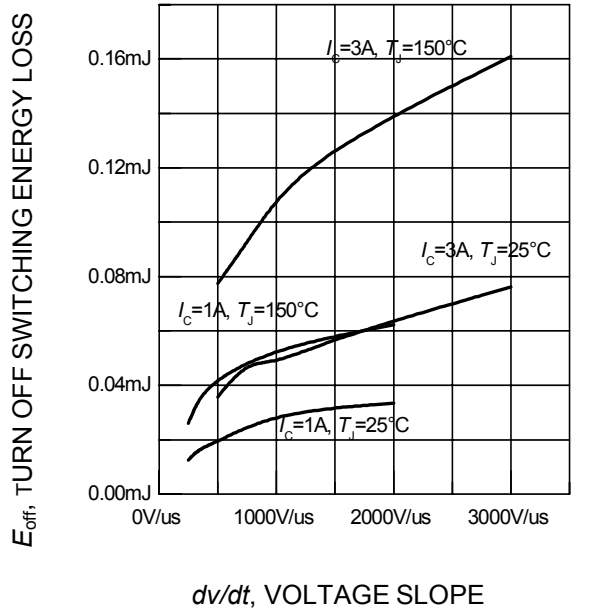
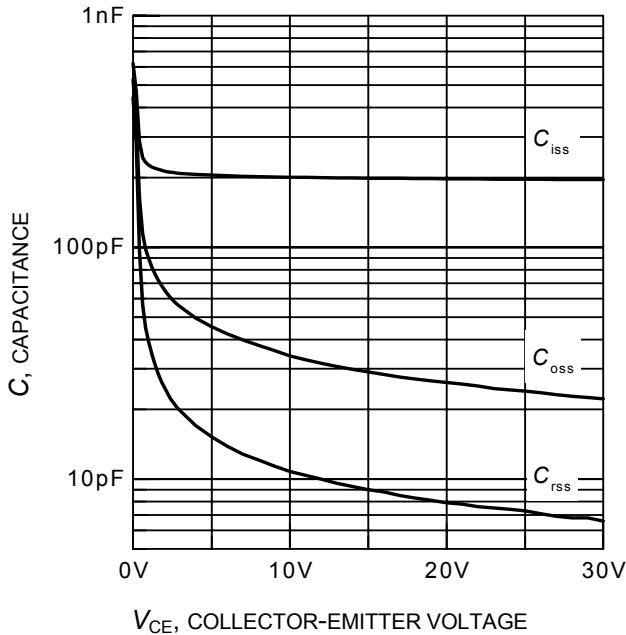
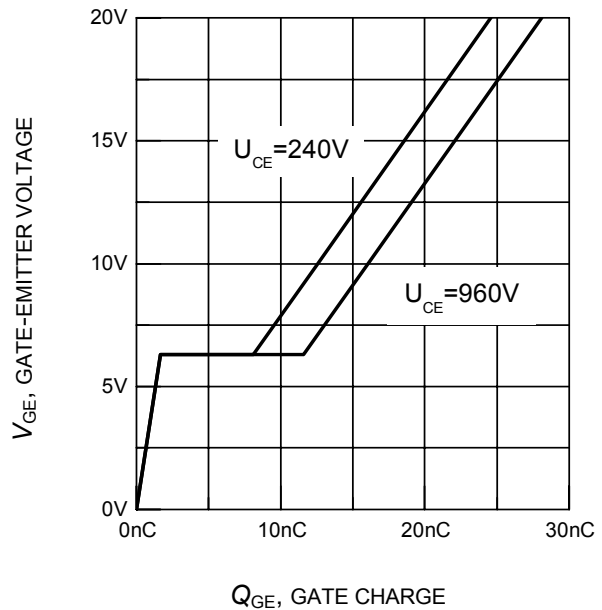

Figure 16. Typical turn off switching energy loss for soft switching
 (dynamic test circuit in Fig. E)



V_{CE} , COLLECTOR-EMITTER VOLTAGE
Figure 17. Typical capacitance as a function of collector-emitter voltage
 ($V_{GE} = 0V, f = 1MHz$)



Q_{GE} , GATE CHARGE
Figure 18. Typical gate charge
 ($I_C = 3A$)

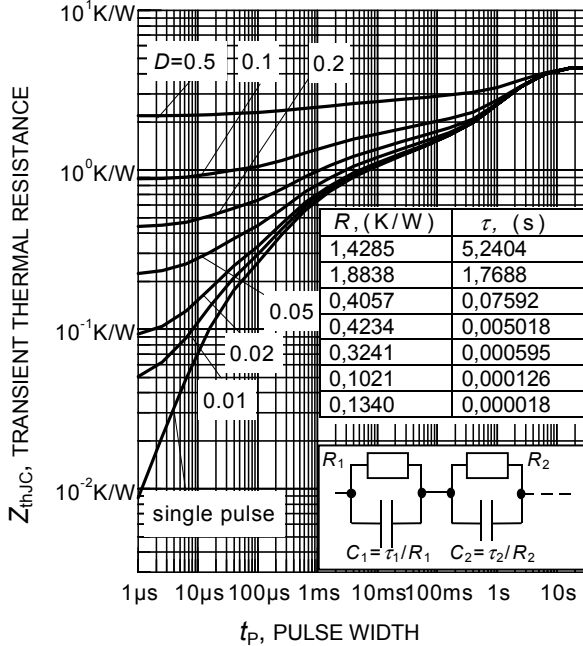

t_p , PULSE WIDTH
Figure 19. Typical IGBT transient thermal impedance as a function of pulse width
 ($D=t_p/T$)

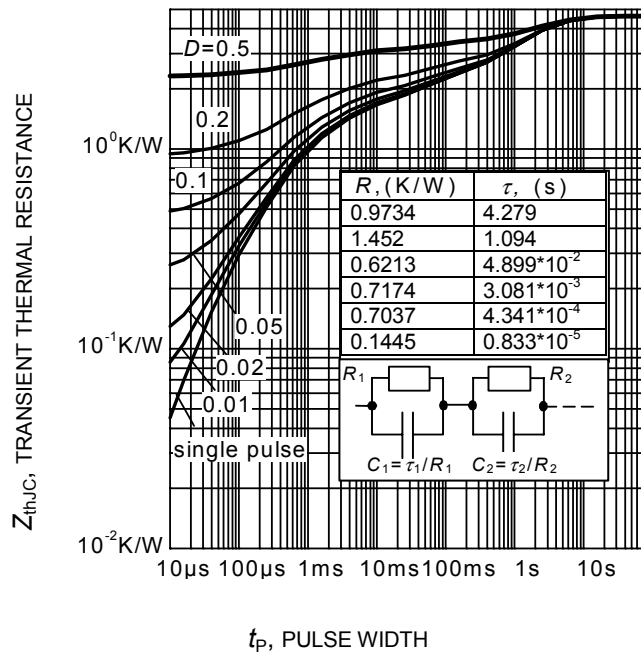

t_p , PULSE WIDTH
Figure 22. Typical Diode transient thermal impedance as a function of pulse width
 ($D=t_p/T$)

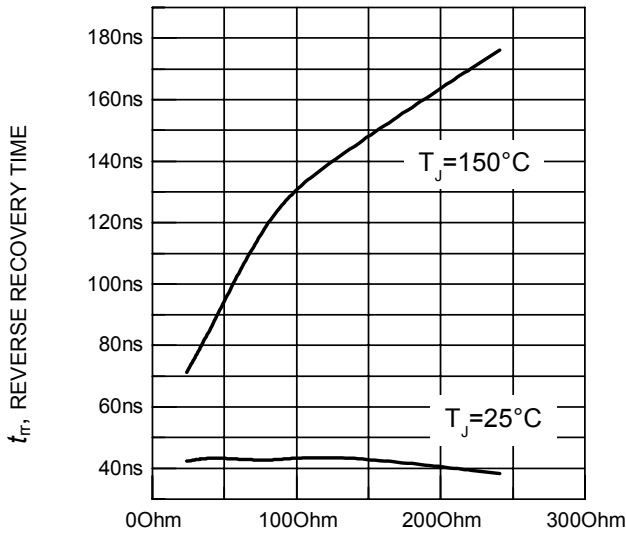

R_G , GATE RESISTANCE

Figure 23. Typical reverse recovery time as a function of diode current slope
 $V_R=800V$, $I_F=3A$,
 Dynamic test circuit in Figure E)

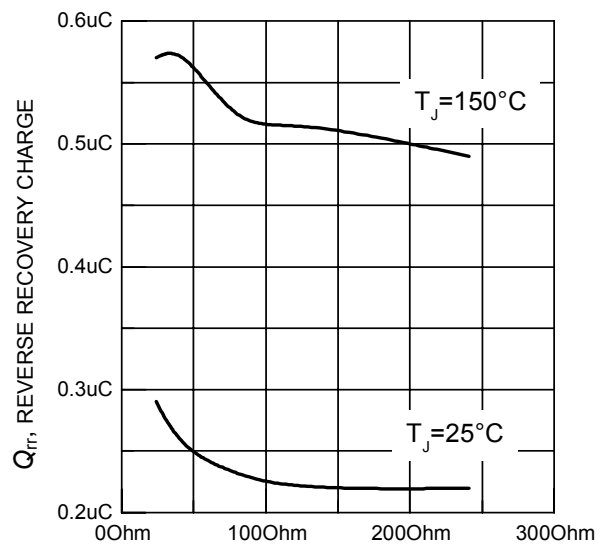

R_G , GATE RESISTANCE

Figure 24. Typical reverse recovery charge as a function of diode current slope
 $(V_R=800V, I_F=3A,$
 Dynamic test circuit in Figure E)

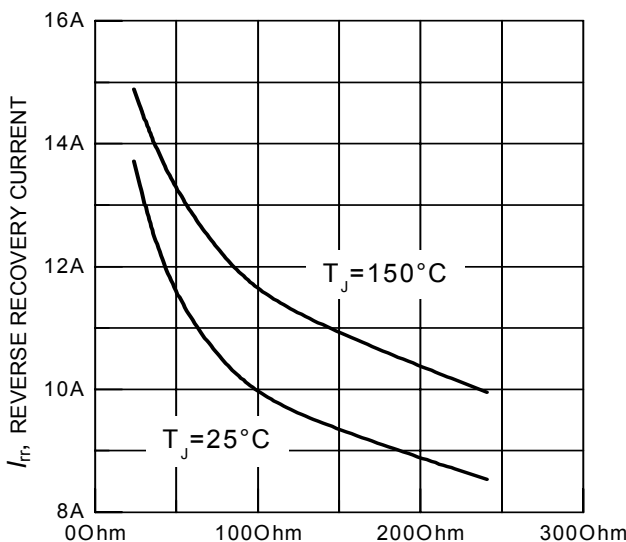

R_G , GATE RESISTANCE

Figure 25. Typical reverse recovery current as a function of diode current slope
 $(V_R=800V, I_F=3A,$
 Dynamic test circuit in Figure E)

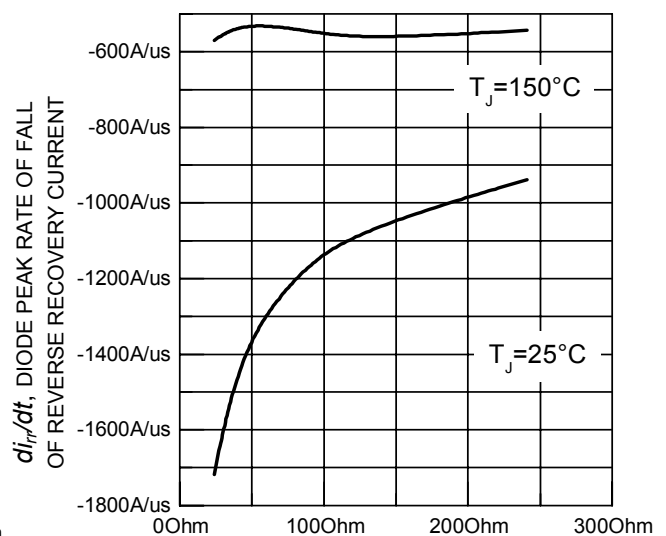

R_G , GATE RESISTANCE

Figure 26. Typical diode peak rate of fall of reverse recovery current as a function of diode current slope
 $(V_R=800V, I_F=3A,$
 Dynamic test circuit in Figure E)

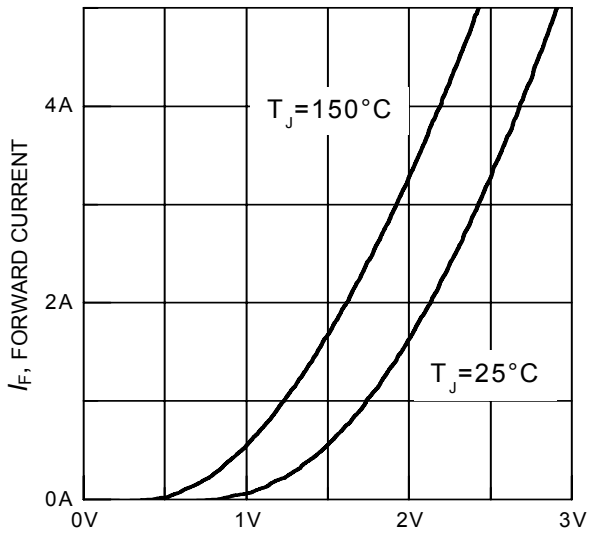

V_F , FORWARD VOLTAGE

Figure 27. Typical diode forward current as a function of forward voltage

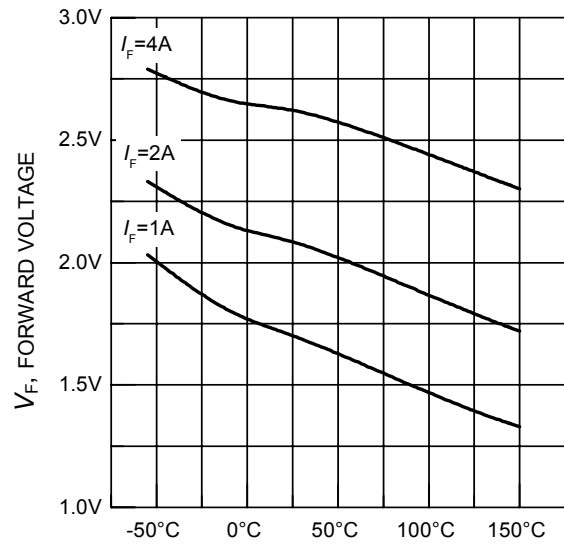

T_J , JUNCTION TEMPERATURE

Figure 28. Typical diode forward voltage as a function of junction temperature

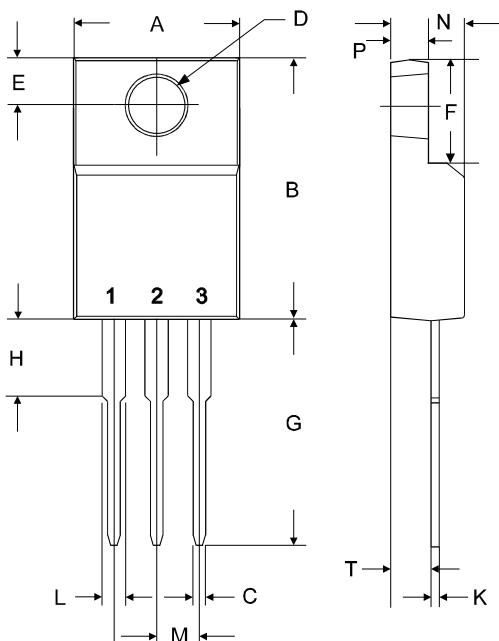
PG-TO-220-3-31 (FullPAK)

symbol	dimensions			
	[mm]		[inch]	
	min	max	min	max
A	10.37	10.63	0.4084	0.4184
B	15.86	16.12	0.6245	0.6345
C	0.65	0.78	0.0256	0.0306
D	2.95 typ.		0.1160 typ.	
E	3.15	3.25	0.124	0.128
F	6.05	6.56	0.2384	0.2584
G	13.47	13.73	0.5304	0.5404
H	3.18	3.43	0.125	0.135
K	0.45	0.63	0.0177	0.0247
L	1.23	1.36	0.0484	0.0534
M	2.54 typ.		0.100 typ.	
N	4.57	4.83	0.1800	0.1900
P	2.57	2.83	0.1013	0.1113
T	2.51	2.62	0.0990	0.1030

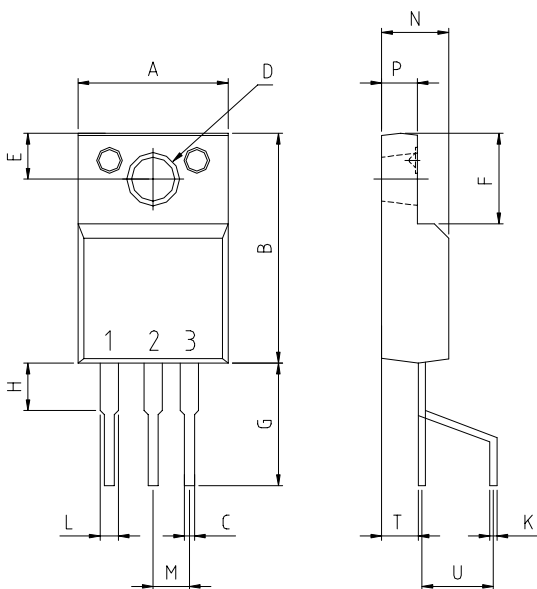
PG-TO-220-3-34 (FullPAK)

symbol	dimensions			
	[mm]		[inch]	
	min	max	min	max
A	10.37	10.63	0.4084	0.4184
B	15.86	16.12	0.6245	0.6345
C	0.65	0.78	0.0256	0.0306
D	2.95 typ.		0.1160 typ.	
E	3.15	3.25	0.124	0.128
F	6.05	6.56	0.2384	0.2584
G	8.28	8.79	0.326	0.346
H	3.18	3.43	0.125	0.135
K	0.45	0.63	0.0177	0.0247
L	1.23	1.36	0.0484	0.0534
M	2.54 typ.		0.100 typ.	
N	4.57	4.83	0.1800	0.1900
P	2.57	2.83	0.1013	0.1113
T	2.51	2.62	0.0990	0.1030
U	5.00 typ.		0.197 typ.	

- 1: Gate
- 2: Collector
- 3: Emitter

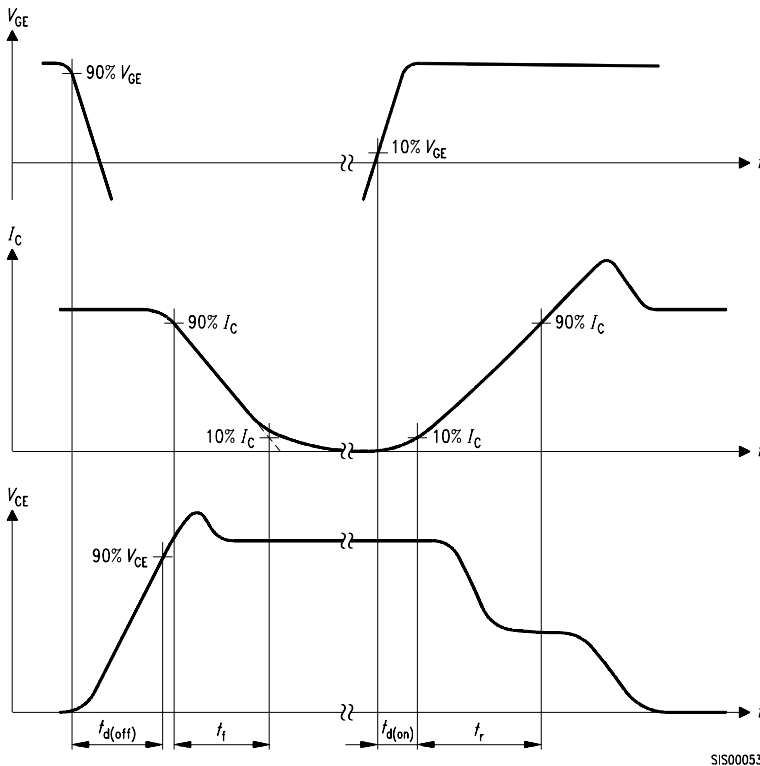
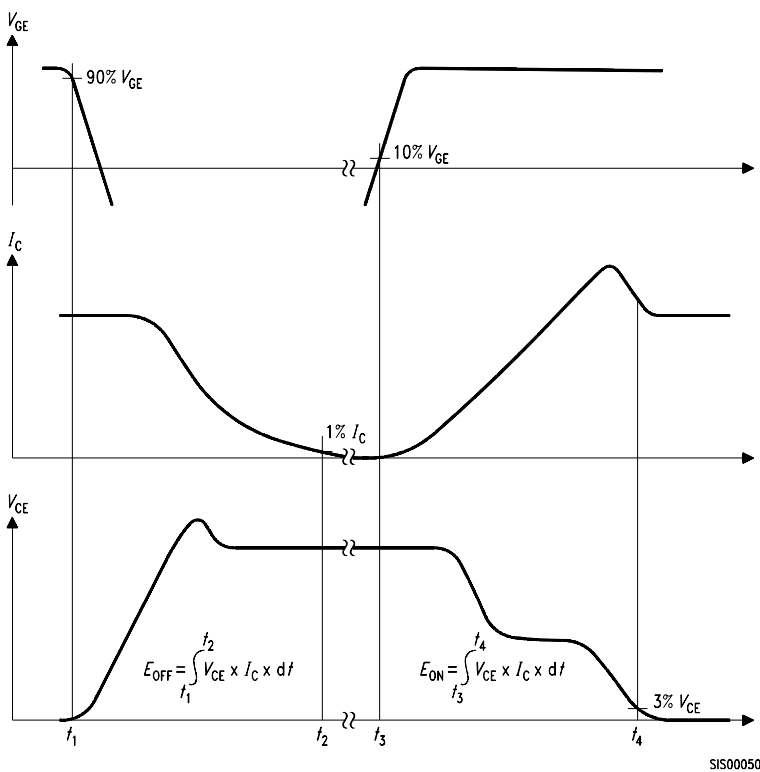
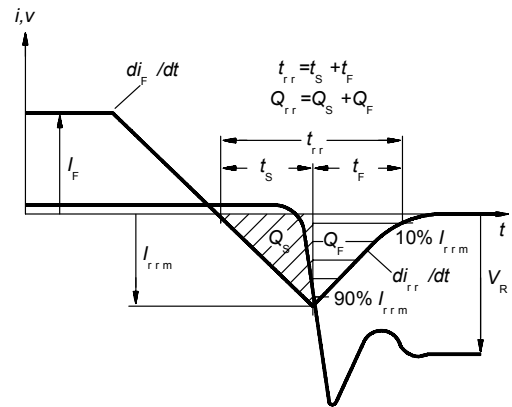
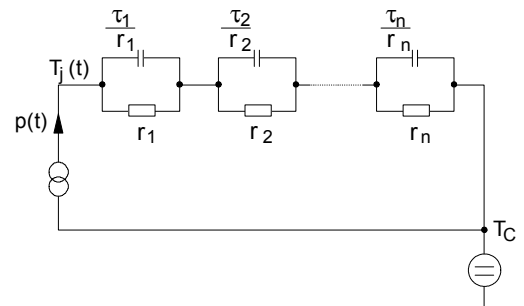
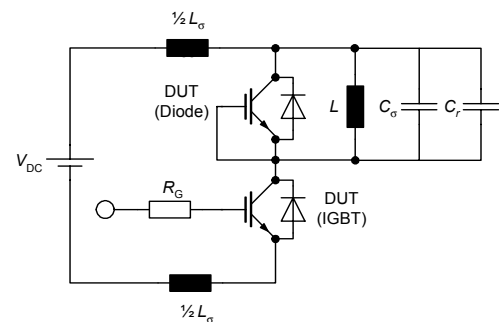
Figure A. Definition of switching times

Figure B. Definition of switching losses

Figure C. Definition of diodes switching characteristics

Figure D. Thermal equivalent circuit

Figure E. Dynamic test circuit
 Leakage inductance $L_{\sigma} = 180\text{nH}$,
 Stray capacitor $C_{\sigma} = 40\text{pF}$,
 Relief capacitor $C_r = 4\text{nF}$ (only for ZVT switching)

Edition 2006-01

**Published by
Infineon Technologies AG
81726 München, Germany**

© Infineon Technologies AG 12/19/06.

All Rights Reserved.

Attention please!

The information given in this data sheet shall in no event be regarded as a guarantee of conditions or characteristics ("Beschaffenheitsgarantie"). With respect to any examples or hints given herein, any typical values stated herein and/or any information regarding the application of the device, Infineon Technologies hereby disclaims any and all warranties and liabilities of any kind, including without limitation warranties of non-infringement of intellectual property rights of any third party.

Information

For further information on technology, delivery terms and conditions and prices please contact your nearest Infineon Technologies Office (www.infineon.com).

Warnings

Due to technical requirements components may contain dangerous substances. For information on the types in question please contact your nearest Infineon Technologies Office.

Infineon Technologies Components may only be used in life-support devices or systems with the express written approval of Infineon Technologies, if a failure of such components can reasonably be expected to cause the failure of that life-support device or system, or to affect the safety or effectiveness of that device or system. Life support devices or systems are intended to be implanted in the human body, or to support and/or maintain and sustain and/or protect human life. If they fail, it is reasonable to assume that the health of the user or other persons may be endangered.