

**PART No. 1418J16**

for more information visit  
[www.hammfg.com](http://www.hammfg.com)

Data subject to change without notice

Isometric drawing Not to Scale

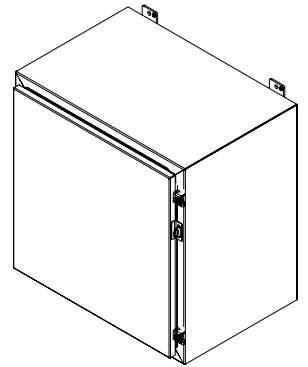

**ISOMETRIC VIEW**

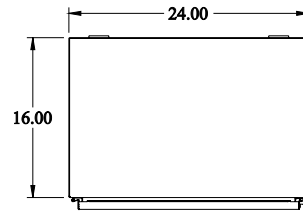

**TOP VIEW**

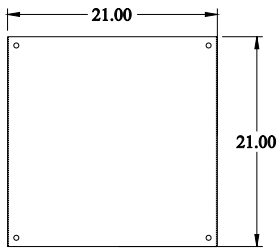

**INNER PANEL**

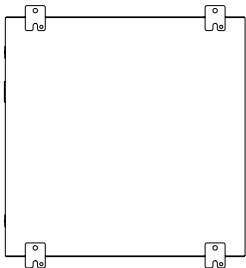

**BACK VIEW**

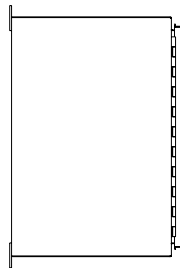

**SIDE VIEW**

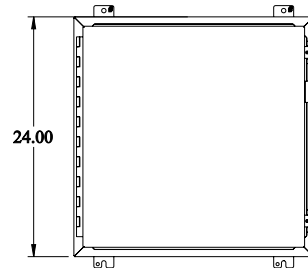

**FRONT VIEW**

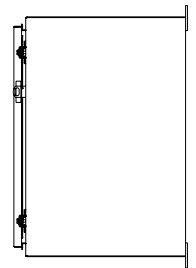

**SIDE VIEW**



**BOTTOM VIEW**