

1 2 3 4 5 6

A

B

C

D

Dichtung
seal

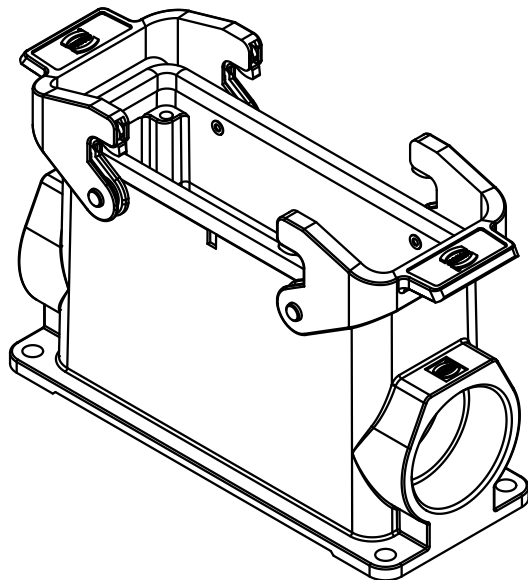
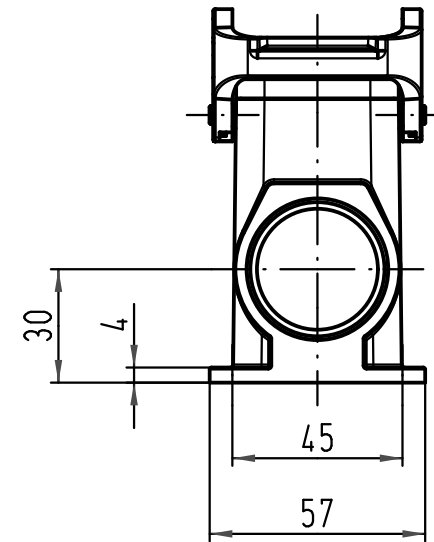
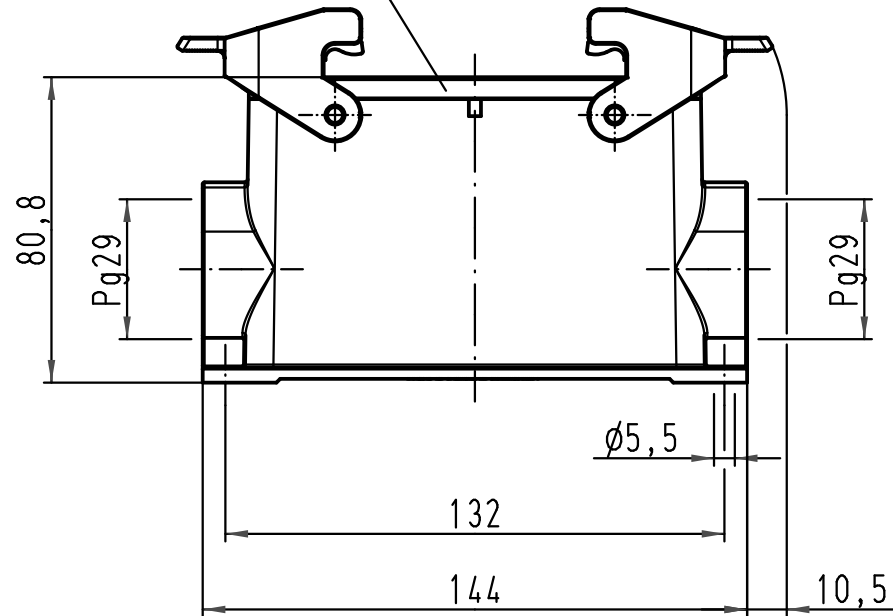

ALL Dimensions in mm Original Size DIN A 4		Techn. Character.			Nicht tolerierte Maß/Free size tolerances	
			Dat.	Name	Maßstab/Scale 1:2	Han 24B-asg2-QB-29 Sockelgehäuse <i>housing surface mounting</i>
		Detail.	04.03.11	Spr		
		Insp.		Be		
		Stand.				
A			HARTING Electric GmbH & Co. KG			TB 09 30 024 0271
Mod.	Dat.	Name	D-32339 Espelkamp			
Sub. TB 09 30 024 0271 v. 10.05.99						Blatt/page