

Low voltage high performance mixer FM IF system

SA608

DESCRIPTION

The SA608 is a low voltage high performance monolithic FM IF system incorporating a mixer/oscillator, two limiting intermediate frequency amplifiers, quadrature detector, logarithmic received signal strength indicator (RSSI), voltage regulator and audio and RSSI op amps. The SA608 is available in 20-lead dual-in-line plastic, 20-lead SOL (surface-mounted miniature package) and 20-lead SSOP package.

The SA608 was designed for portable communication applications and will function down to 2.7V. The RF section is similar to the famous NE605. The audio output is buffered. The RSSI output has an internal amplifier with the feedback pin accessible. The SA608 also has an extra limiter output. This signal is buffered from the output of the limiter and can be used to perform frequency check. This is accomplished by comparing a reference frequency with the frequency check signal using a comparator to a varactor or PLL at the oscillator inputs.

FEATURES

- Low power consumption: 3.5mA typical at 3V
- Mixer input to >150MHz
- Mixer conversion power gain of 17dB at 45MHz
- XTAL oscillator effective to 150MHz (L.C. oscillator or external oscillator can be used at higher frequencies)
- 102dB of IF Amp/Limiter gain
- 2MHz limiter small signal bandwidth
- Temperature compensated logarithmic Received Signal Strength Indicator (RSSI) with a 90dB dynamic range

- Low external component count; suitable for crystal/ceramic/LC filters
- Excellent sensitivity: 0.31µV into 50Ω matching network for 12dB SINAD (Signal to Noise and Distortion ratio) for 1kHz tone, 8kHz deviation with RF at 45MHz and IF at 455kHz
- SA608 meets cellular radio specifications
- Audio output internal op amp
- RSSI output internal op amp
- Buffered frequency check output
- Internal op amps with rail-to-rail outputs
- ESD protection: Human Body Model 2kV Robot Model 200V

APPLICATIONS

- Portable cellular radio FM IF
- Cordless phones
- Narrow band cellular applications (NAMPS/NTACS)
- RF level meter
- Spectrum analyzer
- Instrumentation
- FSK and ASK data receivers
- Log amps
- Portable high performance communication receivers
- Single conversion VHF receivers
- Wireless systems

PIN CONFIGURATION

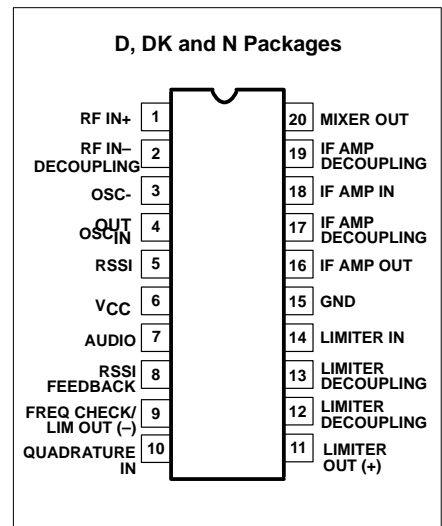

ORDERING INFORMATION

DESCRIPTION	TEMPERATURE RANGE	ORDER CODE	DWG #
20-Pin Plastic Dual In-Line Package (DIP)	-40 to +85°C	SA608N	0408B
20-Pin Plastic Small Outline Large (SOL) package (Surface-mount)	-40 to +85°C	SA608D	0172D
20-Pin Plastic Shrink Small Outline Package (SSOP) (Surface-mount)	-40 to +85°C	SA608DK	1563

Low voltage high performance mixer FM IF system

SA608

BLOCK DIAGRAM

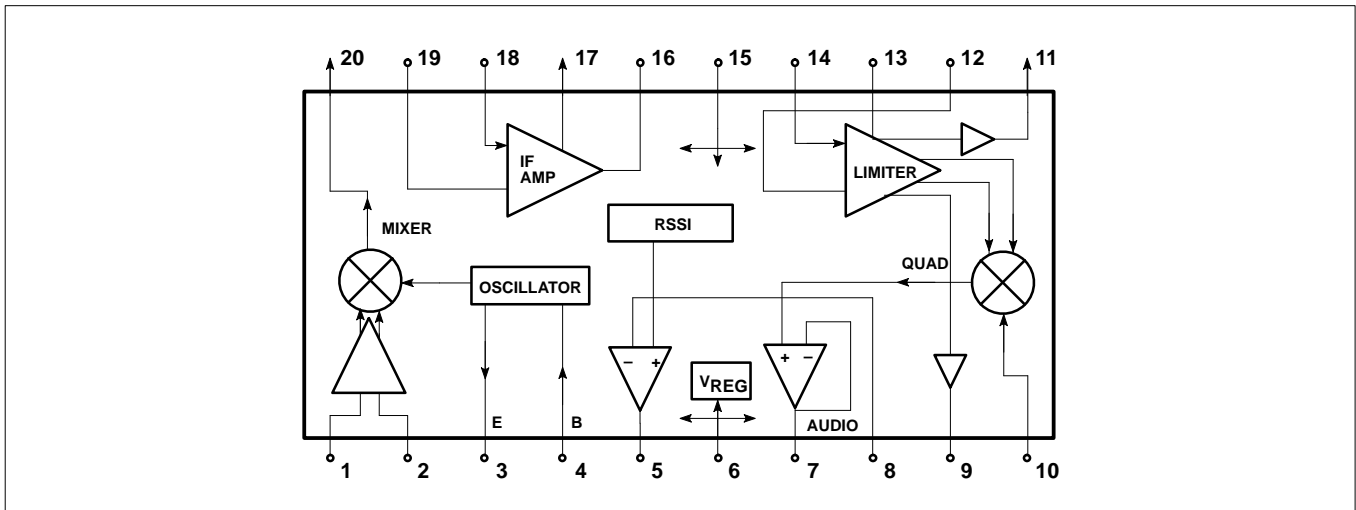

ABSOLUTE MAXIMUM RATINGS

SYMBOL	PARAMETER	RATING	UNITS
V_{CC}	Single supply voltage	7	V
T_{STG}	Storage temperature range	-65 to +150	°C
T_A	Operating ambient temperature range SA608	-40 to +85	°C
θ_{JA}	Thermal impedance D package DK package N package	90 117 75	°C/W

DC ELECTRICAL CHARACTERISTICS

$V_{CC} = +3V$, $T_A = 25^\circ C$; unless otherwise stated.

SYMBOL	PARAMETER	TEST CONDITIONS	LIMITS			UNITS
			SA608			
			MIN	TYP	MAX	
V_{CC}	Power supply voltage range		2.7		7.0	V
I_{CC}	DC current drain			3.5	4.2	mA

Low voltage high performance mixer FM IF system

SA608

AC ELECTRICAL CHARACTERISTICS

$T_A = 25^\circ\text{C}$; $V_{CC} = +3\text{V}$, unless otherwise stated. RF frequency = 45MHz + 14.5dBV RF input step-up; IF frequency = 455kHz; R17 = 2.4k; R18 = 3.3k; RF level = -45dBm; FM modulation = 1kHz with $\pm 8\text{kHz}$ peak deviation. Audio output with de-emphasis filter and C-message weighted filter. Test circuit 1. The parameters listed below are tested using automatic test equipment to assure consistent electrical characteristics. The limits do not represent the ultimate performance limits of the device. Use of an optimized RF layout will improve many of the listed parameters.

SYMBOL	PARAMETER	TEST CONDITIONS	LIMITS			UNITS
			SA608			
			MIN	TYP	MAX	
Mixer/Osc section (ext LO = 220mV_{RMS})						
f_{IN}	Input signal frequency			150		MHz
f_{OSC}	Crystal oscillator frequency			150		MHz
	Noise figure at 45MHz			6.2		dB
	Third-order input intercept point (50 Ω source)	$f_1 = 45.0$; $f_2 = 45.06\text{MHz}$ Input RF Level = -52dBm		-9		dBm
	Conversion power gain	Matched 14.5dBV step-up	13.5	17	19.5	dB
		50 Ω source		+2.5		dB
	RF input resistance	Single-ended input		8		k Ω
	RF input capacitance			3.0	4.0	pF
	Mixer output resistance	(Pin 20)	1.25	1.5		k Ω
IF section						
	IF amp gain	50 Ω source		44		dB
	Limiter gain	50 Ω source		58		dB
	Input limiting -3dB, $R_{17} = 2.4\text{k}$	Test at Pin 18		-109		dBm
	AM rejection	80% AM 1kHz		45		dB
	Audio level ²		35	60	80	mV
	SINAD sensitivity	RF level -110dB		17		dB
THD	Total harmonic distortion		-35	-50		dB
S/N	Signal-to-noise ratio	No modulation for noise		62		dB
	IF RSSI output, $R_g = 2\text{k}\Omega^1$	IF level = -118dBm		0.3	0.8	V
		IF level = -68dBm	.70	1.1	1.80	V
		IF level = -23dBm	1.2	1.8	2.5	V
	RSSI range			90		dB
	RSSI accuracy			± 1.5		dB
	IF input impedance		1.3	1.5		k Ω
	IF output impedance			0.3		k Ω
	Limiter input impedance		1.30	1.5		k Ω
	Limiter output impedance	(Pin 11)		200		Ω
	Limiter output level	(Pin 11) no load		130		mV _{RMS}
		(Pin 11) 5k Ω load			115	
	Frequency check/lim (-) output impedance	(Pin 9)		200		Ω
	Frequency check/lim (-) output level	(Pin 9) no load		130		mV _{RMS}
		(Pin 9) 5k Ω load			115	
RF/IF section (int LO)						
	Audio level	3V = V_{CC} , RF level = -27dBm		120		mV _{RMS}
	System RSSI output	3V = V_{CC} , RF level = -27dBm		2.2		V
	System SINAD sensitivity	RF level = -117dBm		12		dB

NOTE:

1. The generator source impedance is 50 Ω , but the SA608 input impedance at Pin 18 is 1500 Ω . As a result, IF level refers to the actual signal that enters the SA608 input (Pin 18) which is about 21dB less than the "available power" at the generator.
2. By using 45k Ω load across the Quad detector coil, you will have Audio output at 115mV with -42dB distortion.

Low voltage high performance mixer FM IF system

SA608

CIRCUIT DESCRIPTION

The SA608 is an IF signal processing system suitable for second IF systems with input frequency as high as 150MHz. The bandwidth of the IF amplifier and limiter is at least 2MHz with 90dB of gain. The gain/bandwidth distribution is optimized for 455kHz, 1.5k Ω source applications. The overall system is well-suited to battery operation as well as high performance and high quality products of all types.

The input stage is a Gilbert cell mixer with oscillator. Typical mixer characteristics include a noise figure of 6.2dB, conversion gain of 17dB, and input third-order intercept of -9dBm. The oscillator will operate in excess of 200MHz in L/C tank configurations. Hartley or Colpitts circuits can be used up to 100MHz for xtal configurations. Butler oscillators are recommended for xtal configurations up to 150MHz.

The output impedance of the mixer is a 1.5k Ω resistor permitting direct connection to a 455kHz ceramic filter. The input resistance of the limiting IF amplifiers is also 1.5k Ω .

With most 455kHz ceramic filters and many crystal filters, no impedance matching network is necessary. The IF amplifier has 43dB of gain and 5.5MHz bandwidth. The IF limiter has 60dB of gain and 4.5MHz bandwidth. To achieve optimum linearity of the log signal strength indicator, there must be a 12dB(v) insertion loss between the first and second IF stages. If the IF filter or interstage network does not cause 12dB(v) insertion loss, a fixed or variable resistor or an L pad for simultaneous loss and impedance matching can be added between the first IF output (Pin 16) and the interstage network. The overall gain will then be 90dB with 2MHz bandwidth.

The signal from the second limiting amplifier goes to a Gilbert cell quadrature detector. One port of the Gilbert cell is internally driven by the IF. The other output of the IF is AC-coupled to a tuned quadrature network. This signal, which now has a 90° phase relationship to the internal signal, drives the other port of the multiplier cell.

The demodulated output of the quadrature drives an internal op amp. This op amp is configured as a unity gain buffer.

A log signal strength indicator completes the circuitry. The output range is greater than 90dB and is temperature compensated. This log signal strength indicator exceeds the criteria for AMPs or TACs cellular telephone. This signal is buffered through an internal unity gain op amp. The frequency check pin provides a buffered limiter output. This is useful for implementing an AFC (Automatic Frequency Check) function. This same output can also be used in conjunction with limiter output (Pin 11) for demodulating FSK (Frequency Shift Keying) data. Both pins are of the same amplitude, but 180° out of phase.

NOTE: Limiter or Frequency Check output has drive capability of a 5k Ω minimum or higher in order to obtain 120mV_{RMS} output level.

NOTE: $dB(v) = 20 \log V_{OUT}/V_{IN}$

Low voltage high performance mixer FM IF system

SA608

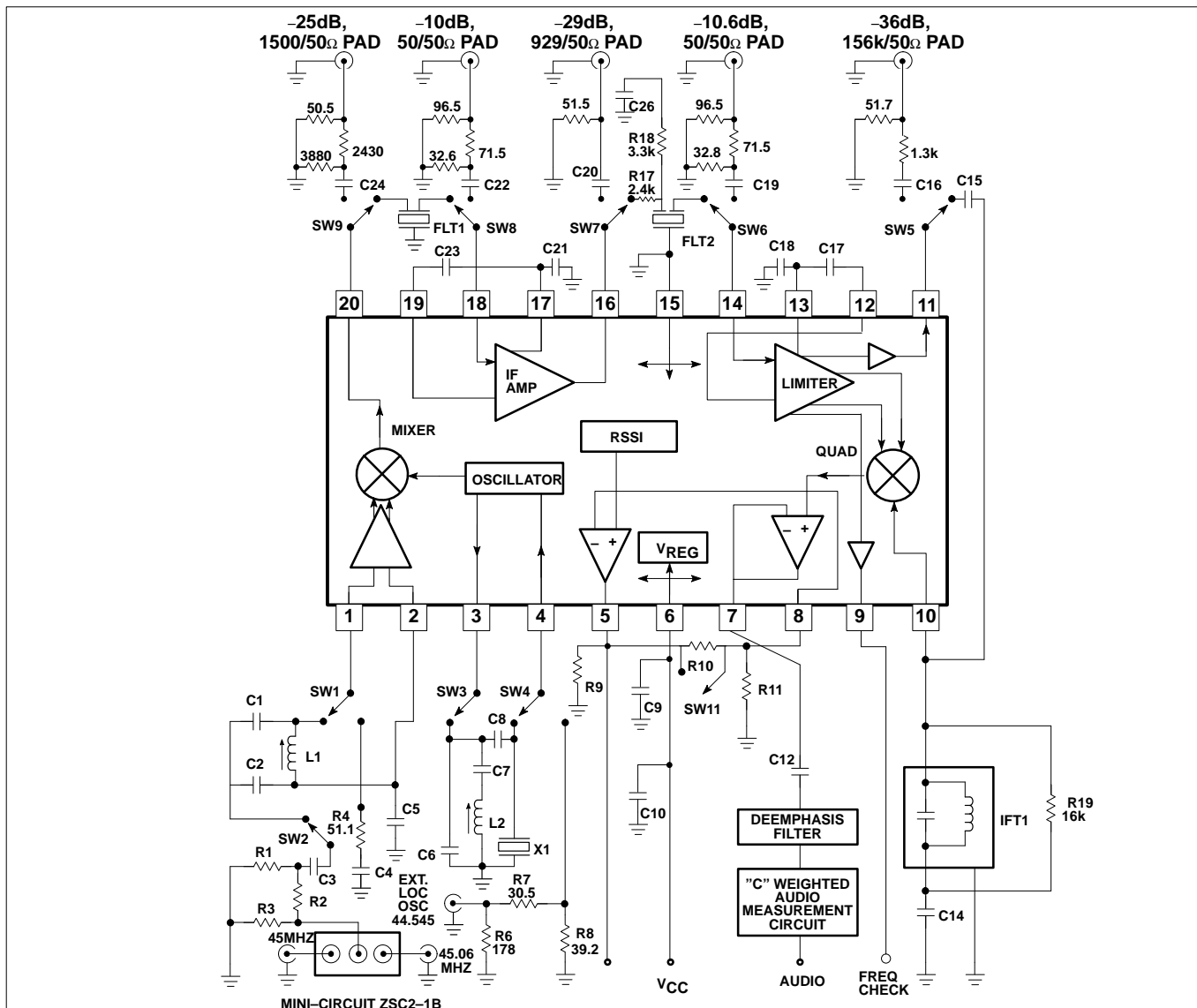

Automatic Test Circuit Component List

- | | | | |
|-----|-------------------------------|-------|---|
| C1 | 100pF NPO Ceramic | C26 | 0.1μF ±10% Monolithic Ceramic |
| C2 | 390pF NPO Ceramic | C27 | 2.2μF |
| C5 | 100nF ±10% Monolithic Ceramic | Flt 1 | Ceramic Filter Murata SFG455A3 or equiv |
| C6 | 22pF NPO Ceramic | Flt 2 | Ceramic Filter Murata SFG455A3 or equiv |
| C7 | 1nF Ceramic | IFT 1 | 455kHz (Ce = 180pF) Toko RMC-2A6597H |
| C8 | 10.0pF NPO Ceramic | L1 | 147-160nH Coilcraft UNI-10/142-04J08S |
| C9 | 100nF ±10% Monolithic Ceramic | L2 | 0.8μH nominal |
| C10 | 10μF Tantalum (minimum) * | | Toko 292CNS-T1038Z |
| C12 | 2.2μF | X1 | 44.545MHz Crystal ICM4712701 |
| C14 | 100nF ±10% Monolithic Ceramic | R9 | 2kΩ ±1% 1/4W Metal Film |
| C15 | 10pF NPO Ceramic | R10 | 10kΩ ±1% |
| C17 | 100nF ±10% Monolithic Ceramic | R11 | 10kΩ ±1% |
| C18 | 100nF ±10% Monolithic Ceramic | R14 | 5kΩ ±1% |
| C21 | 100nF ±10% Monolithic Ceramic | R17 | 2.4kΩ ±5% 1/4W Carbon Composition |
| C23 | 100nF ±10% Monolithic Ceramic | R18 | 3.3kΩ ±5% 1/4W Carbon Composition |
| C25 | 100nF ±10% Monolithic Ceramic | R19 | 16kΩ ±5% 1/4W Carbon Composition |

*NOTE: This value can be reduced when a battery is the power source.

Figure 1. SA607 45MHz Test Circuit (Relays as shown)

Low voltage high performance mixer FM IF system

SA608

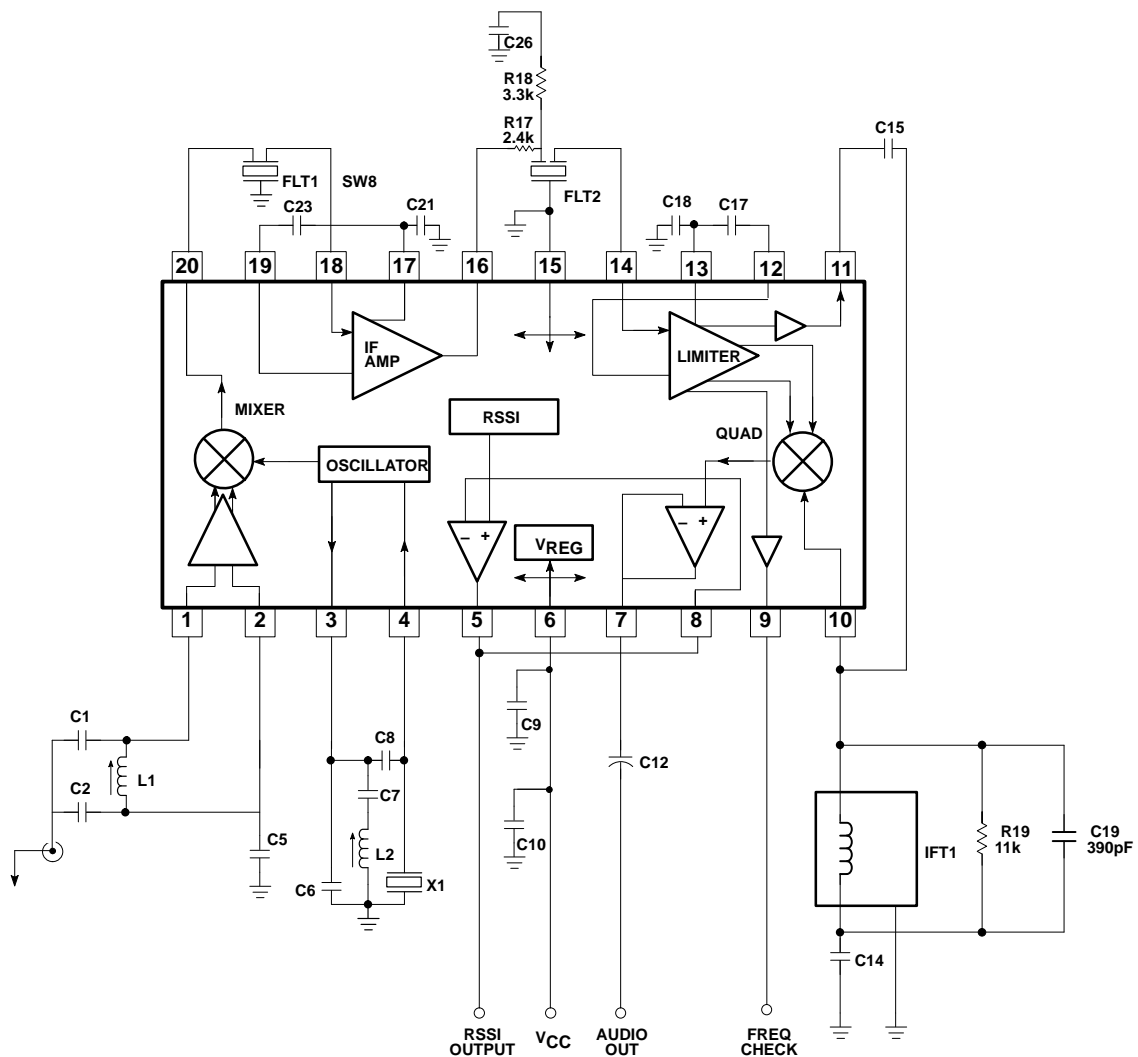

Product Board SA608D/DK Component List

C1	51pF NPO Ceramic	C25	100nF ±10% Monolithic Ceramic
C2	220pF NPO Ceramic	C26	0.1µF ±10% Monolithic Ceramic
C5	100nF ±10% Monolithic Ceramic	C27	2.2µF
C6	5-30pF NPO Ceramic	Flt 1	Ceramic Filter Murata SFG455A3 or equiv
C7	1nF Ceramic	Flt 2	Ceramic Filter Murata SFG455A3 or equiv
C8	10.0pF NPO Ceramic	IFT 1	330µH TOKO 303LN-1130
C9	100nF ±10% Monolithic Ceramic	L1	0.33µH TOKO SCB-1320Z
C10	10µF Tantalum (minimum) *	L2	1.2µH Coilcraft 1008CS-122
C12	2.2µF	X1	44.545MHz Crystal Hy-Q
C14	100nF ±10% Monolithic Ceramic	R9	2kΩ ±1% 1/4W Metal Film
C15	10pF NPO Ceramic	R10	8.2kΩ ±1%
C17	100nF ±10% Monolithic Ceramic	R11	10kΩ ±1%
C18	100nF ±10% Monolithic Ceramic	R14	10kΩ ±1%
C19	390pF ±10% Monolithic Ceramic	R17	2.4kΩ ±5% 1/4W Carbon Composition
C21	100nF ±10% Monolithic Ceramic	R18	3.3kΩ ±5% 1/4W Carbon Composition
C23	100nF ±10% Monolithic Ceramic	R19	16kΩ ±5% 1/4W Carbon Composition

*NOTE: This value can be reduced when a battery is the power source.

Figure 2. SA608 45MHz Test Circuit (Relays as shown)

Low voltage high performance mixer FM IF system

SA608

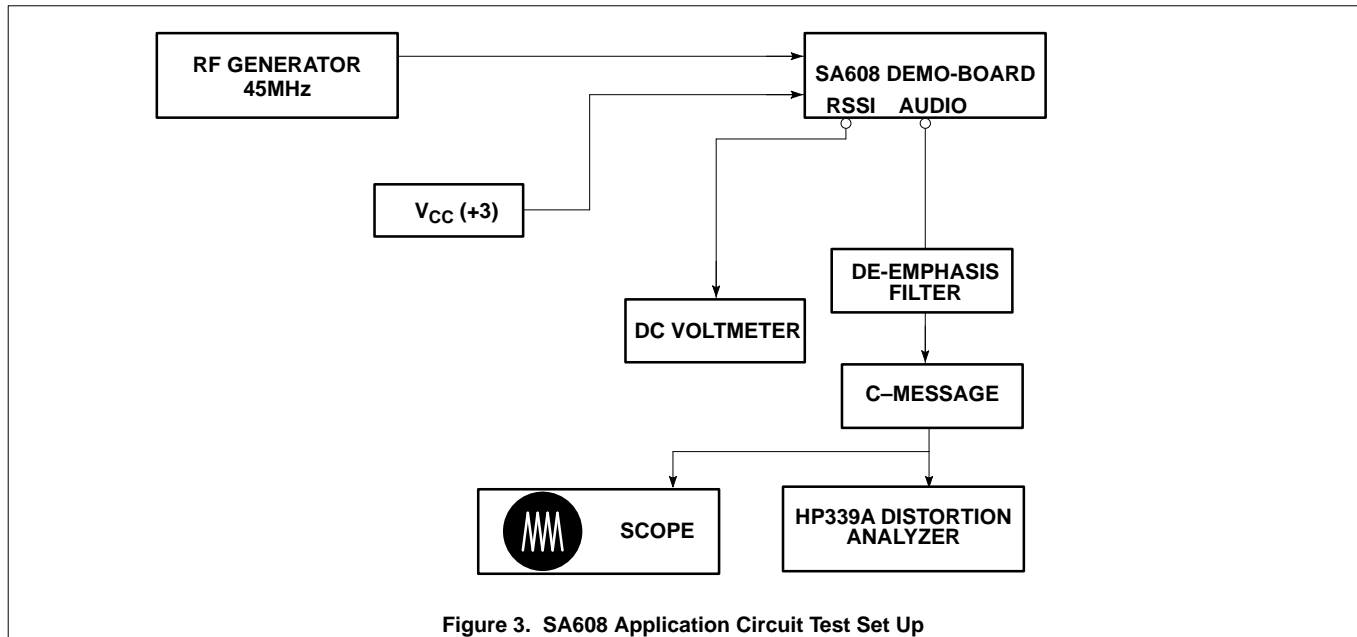
**NOTES:**

1. C-message: The C-message and de-emphasis filter combination has a peak gain of 10 for accurate measurements. Without the gain, the measurements may be affected by the noise of the scope and HP339 analyzer. The de-emphasis filter has a fixed -6dB/Octave slope between 300Hz and 3kHz.
2. Ceramic filters: The ceramic filters can be 30kHz SFG455A3s made by Murata which have 30kHz IF bandwidth (they come in blue), or 16kHz CFU455Ds, also made by Murata (they come in black). All of our specifications and testing are done with the more wideband filter.
3. RF generator: Set your RF generator at 45.000MHz, use a 1kHz modulation frequency and a 6kHz deviation if you use 16kHz filters, or 8kHz if you use 30kHz filters.
4. Sensitivity: The measured typical sensitivity for 12dB SINAD should be 0.35 μ V or -116dBm at the RF input.
5. Layout: The layout is very critical in the performance of the receiver. We highly recommend our demo board layout.
6. RSSI: The smallest RSSI voltage (i.e., when no RF input is present and the input is terminated) is a measure of the quality of the layout and design. If the lowest RSSI voltage is 500mV or higher, it means the receiver is in regenerative mode. In that case, the receiver sensitivity will be worse than expected.
7. Supply bypass and shielding: All of the inductors, the quad tank, and their shield must be grounded. A 10-15 μ F or higher value tantalum capacitor on the supply line is essential. A low frequency ESR screening test on this capacitor will ensure consistent good sensitivity in production. A 0.1 μ F bypass capacitor on the supply pin, and grounded near the 44.545MHz oscillator improves sensitivity by 2-3dB.
8. R5 can be used to bias the oscillator transistor at a higher current for operation above 45MHz. Recommended value is 22k Ω , but should not be below 10k Ω .

Low voltage high performance mixer FM IF system

SA608

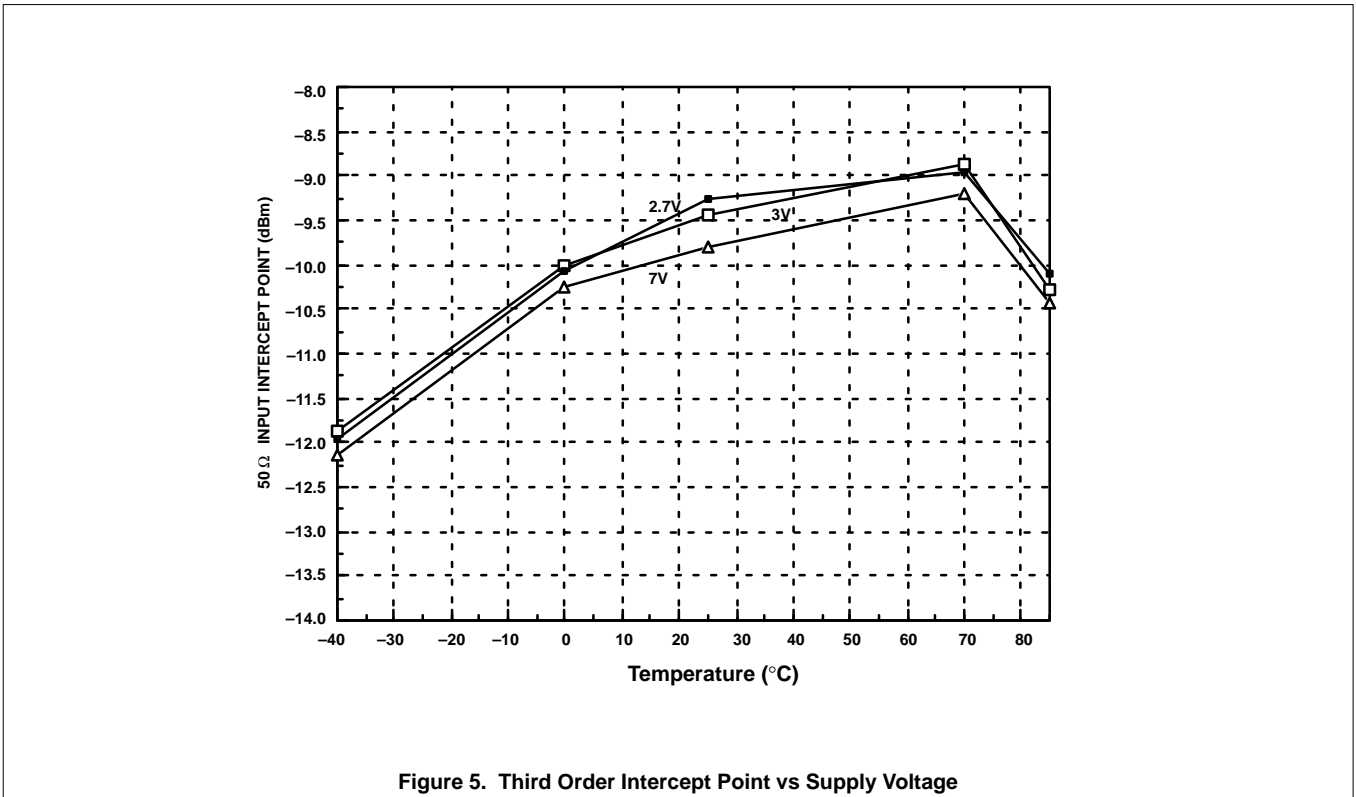
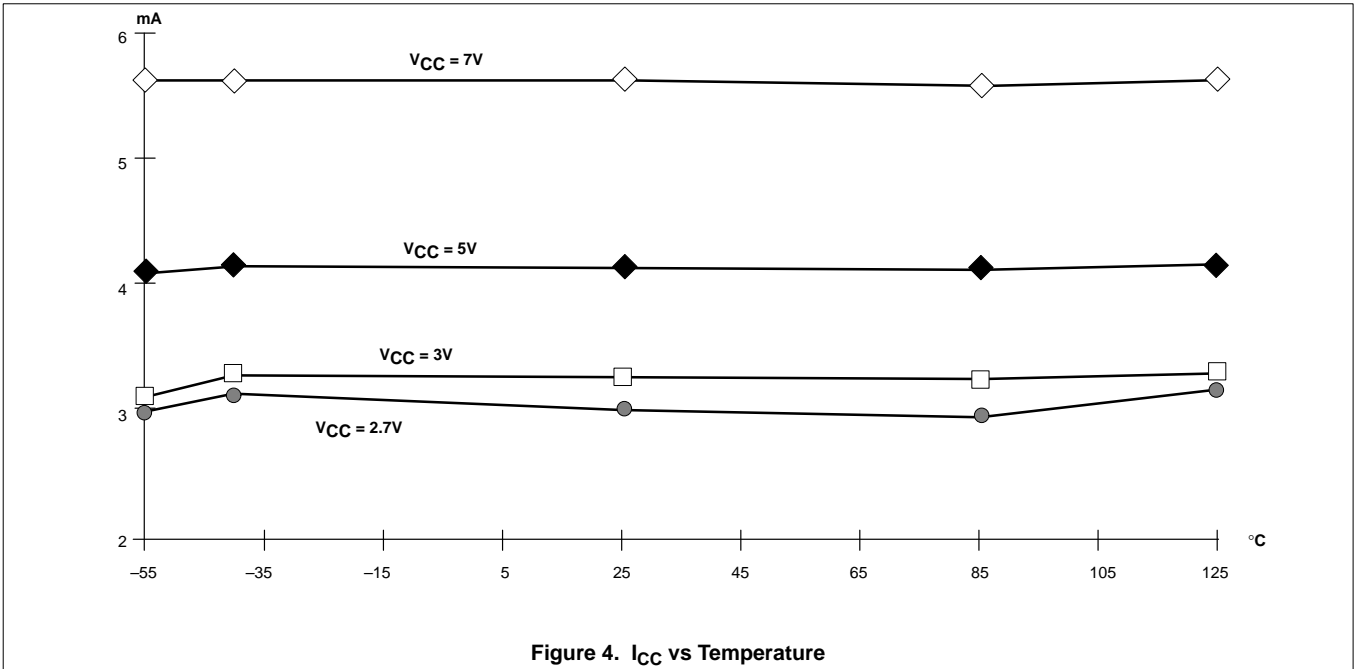

Low voltage high performance mixer FM IF system

SA608

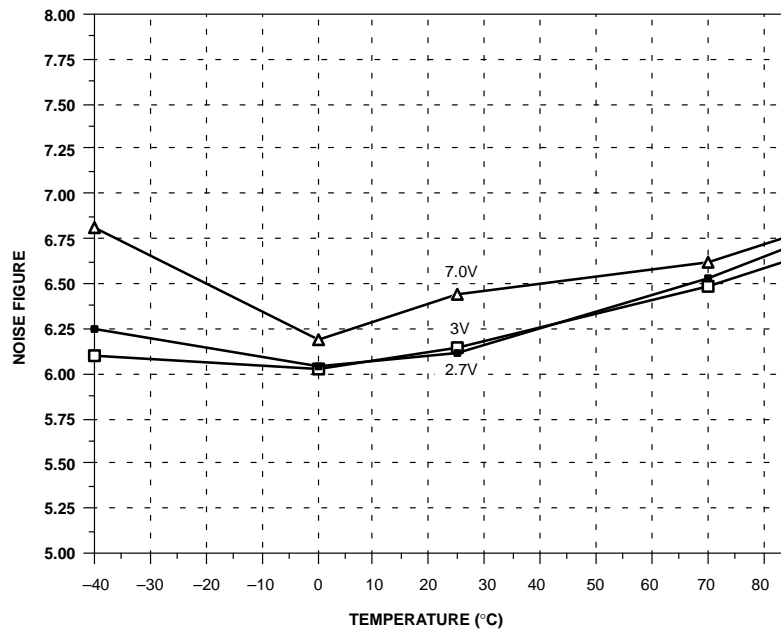

Figure 6. Mixer Noise Figure vs Supply Voltage

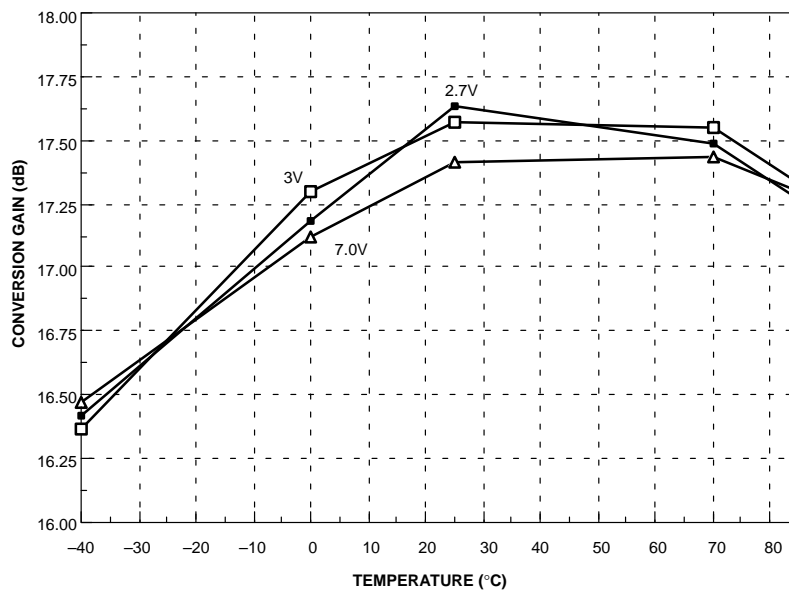

Figure 7. Conversion Gain vs Supply Voltage

Low voltage high performance mixer FM IF system

SA608

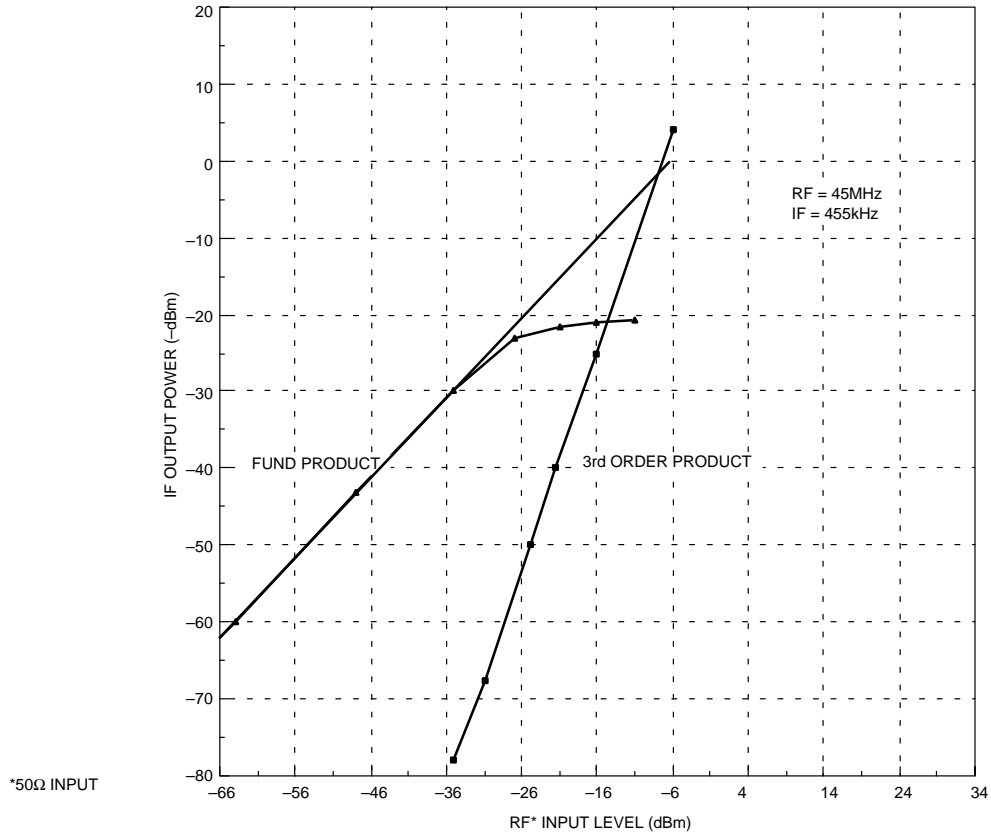

Figure 8. Mixer Third Order Intercept and Compression

Low voltage high performance mixer FM IF system

SA608

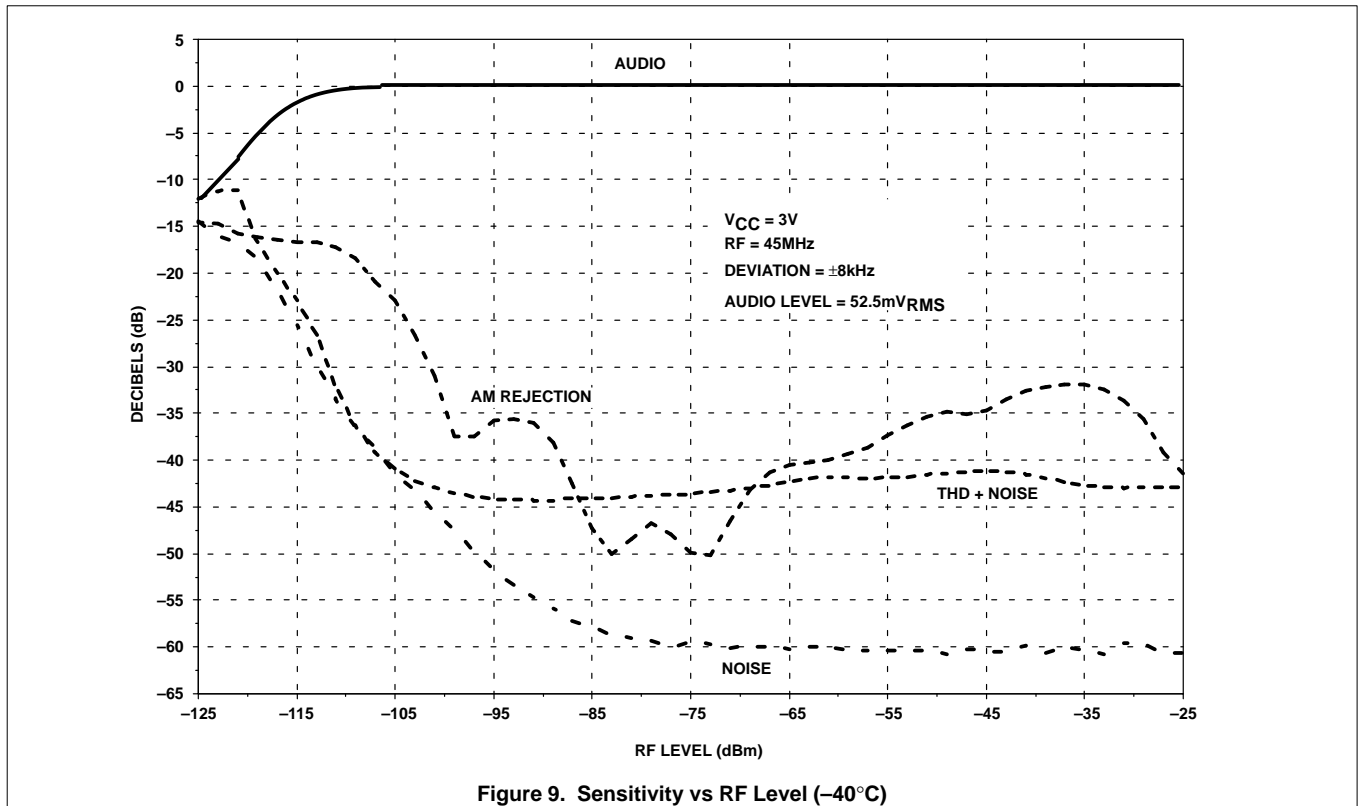

Figure 9. Sensitivity vs RF Level (-40°C)

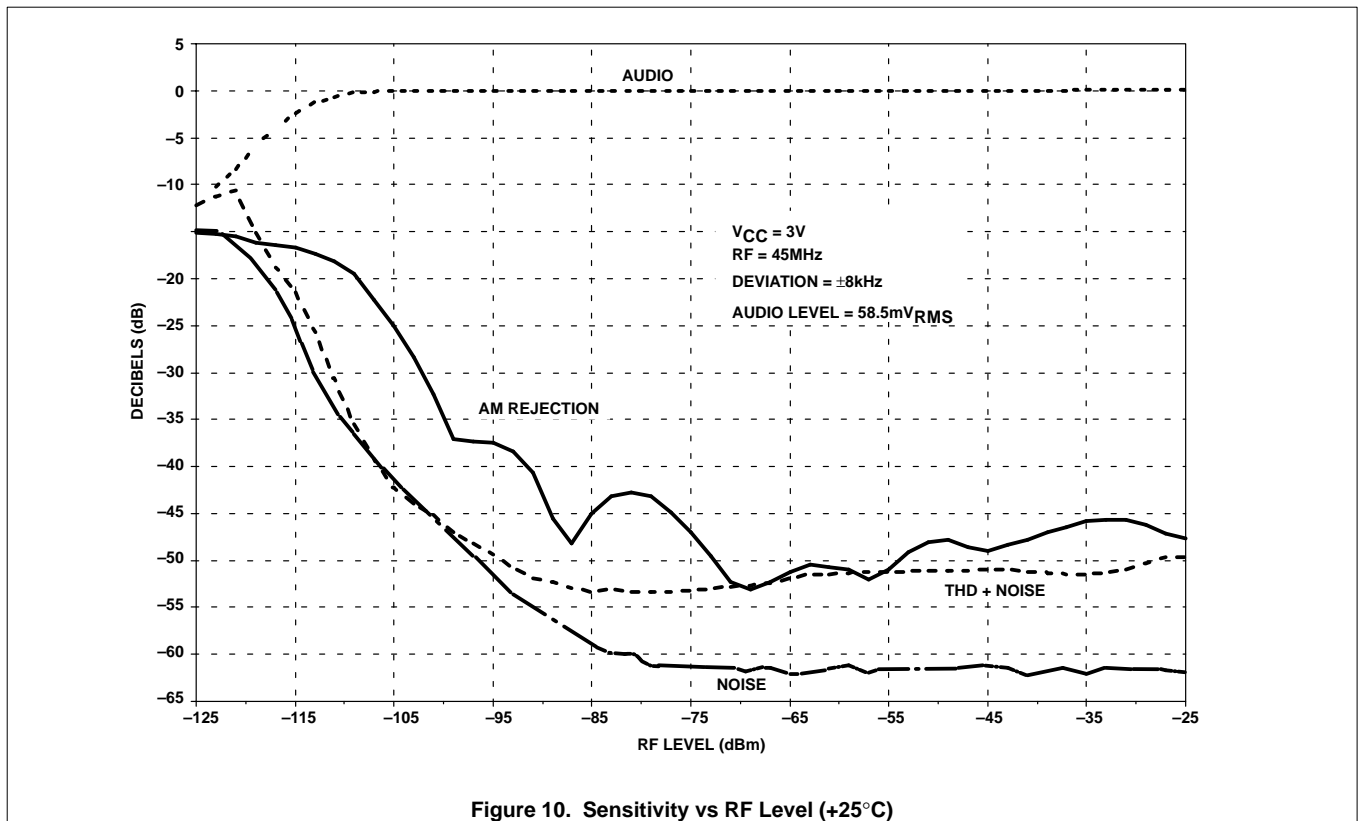

Figure 10. Sensitivity vs RF Level (+25°C)

Low voltage high performance mixer FM IF system

SA608

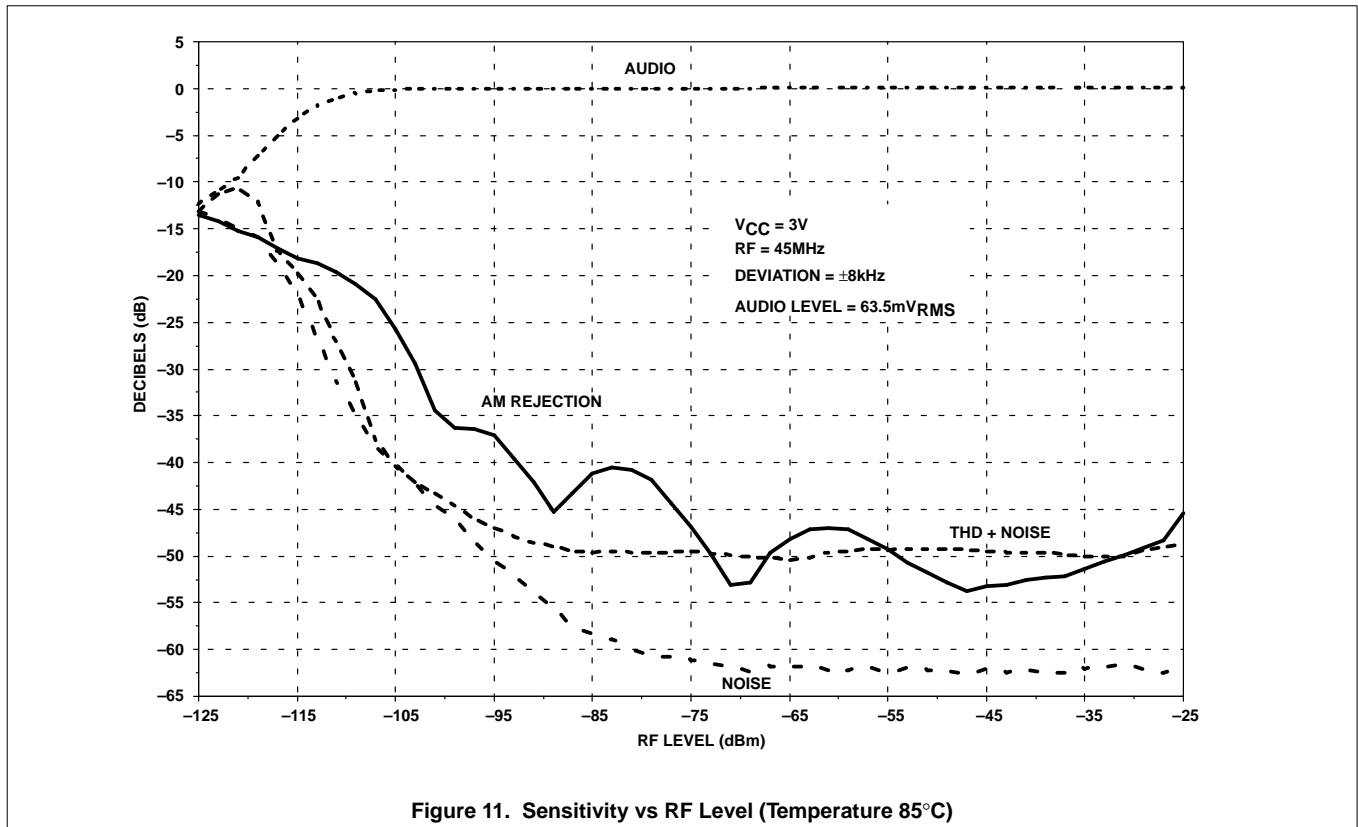

Figure 11. Sensitivity vs RF Level (Temperature 85°C)

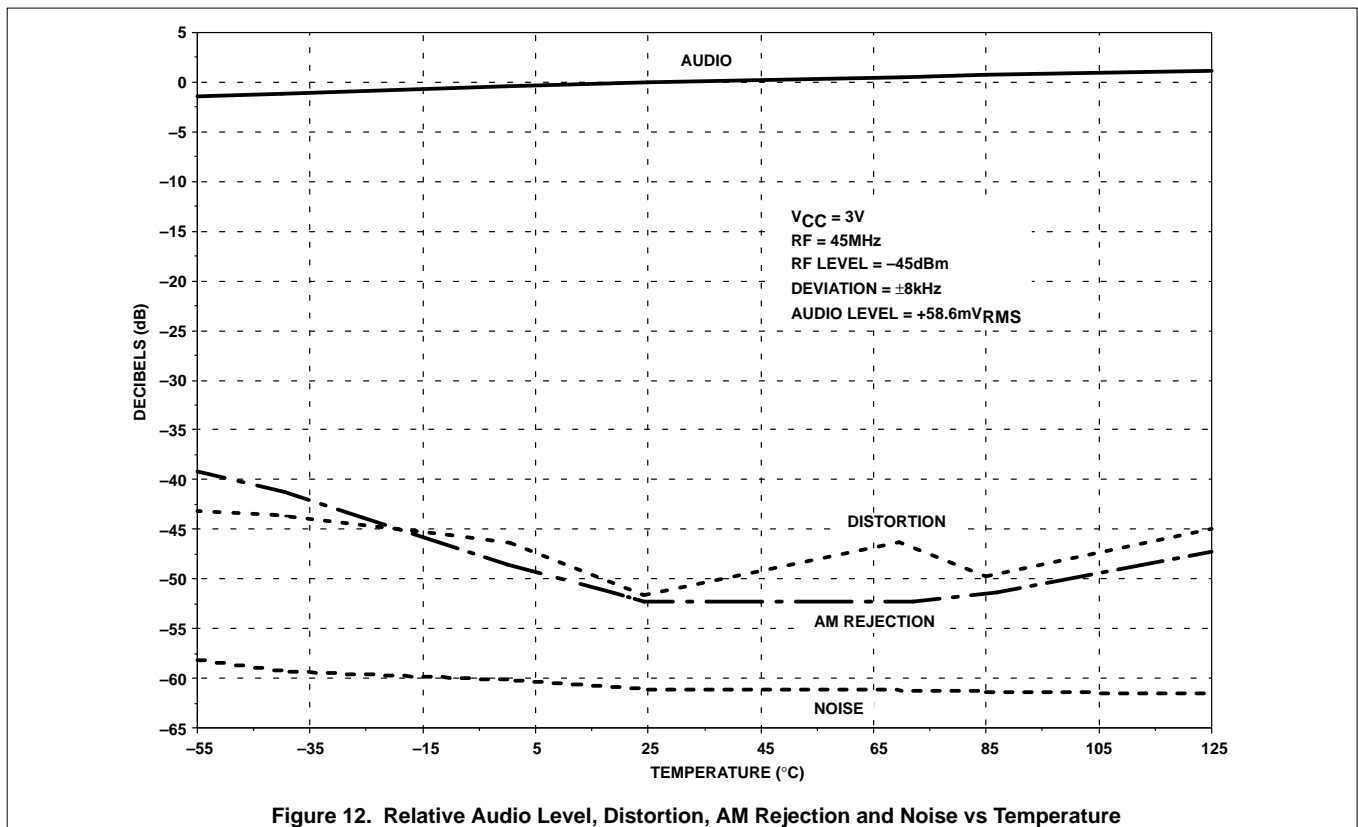
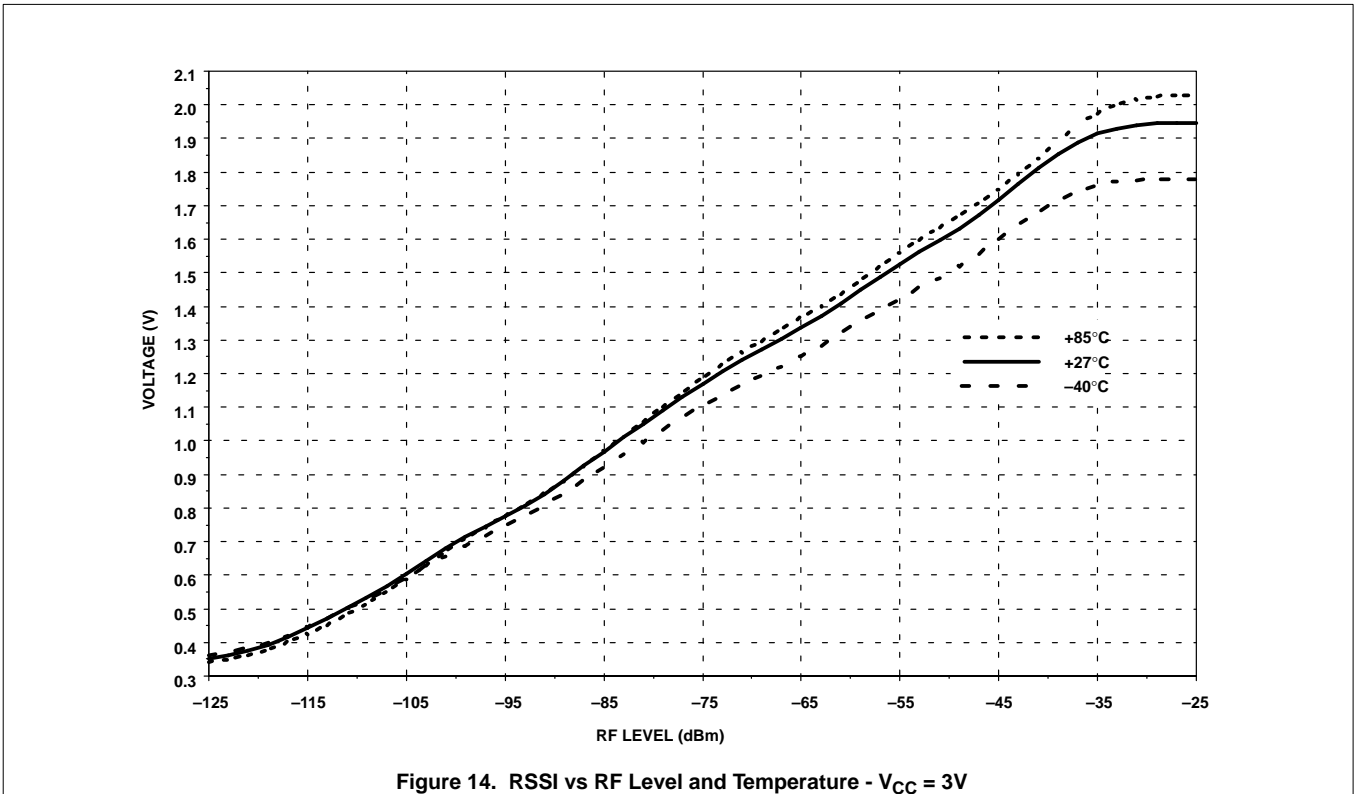
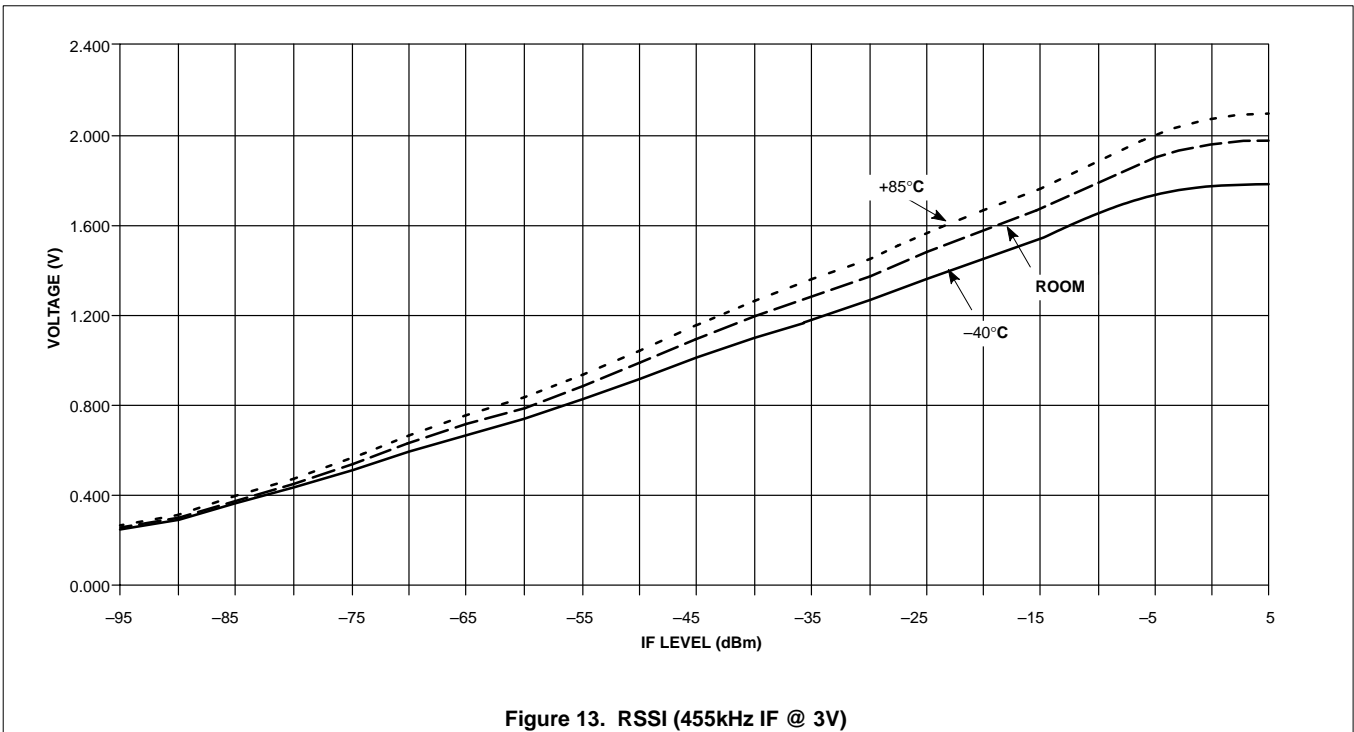

Figure 12. Relative Audio Level, Distortion, AM Rejection and Noise vs Temperature

Low voltage high performance mixer FM IF system

SA608



Low voltage high performance mixer FM IF system

SA608

