



Features

- Bidirectional ESD protection
- Low clamping voltage
- Ultra-small SMD package
- RoHS compliant*

Applications

- Portable electronics
- Cellular handsets and accessories
- Audio & video equipment
- Communication systems
- Computers and peripherals

CD0201-T20C - Surface Mount TVS Diode

General Information

The Bourns® Model CD0201-T20C device provides signal and power line ESD protection for electronic devices such as cellular phones, handheld electronics and other portable electronic applications.

The device is available in a compact industry-standard 0201 sized chip package (0603 metric measuring 0.6 mm x 0.3 mm). It is intended to be mounted directly onto a printed circuit board.

The device is designed to meet IEC 61000-4-2 (ESD) protection requirements. The combination of its small size and high ESD surge capability makes the Model CD0201-T20C well-suited for use in protecting sensitive electronics from damage or latch-up due to ESD in portable applications.

The Model CD0201-T20C TVS diode has a working peak voltage of 20 V.



Maximum Ratings (@ T_A = 25 °C Unless Otherwise Noted)

Parameter	Symbol	Value	Unit
Maximum Working Peak Reverse Voltage	V _{RWM}	±20	V
ESD Protection per IEC 61000-4-2 Contact Discharge Air Discharge	V _{ESD}	±20 ±20	kV
Operating Temperature Range	T _{OPR}	-55 to +85	°C
Storage Temperature Range	T _{STG}	-55 to +150	°C

Electrical Characteristics (@ T_A = 25 °C Unless Otherwise Noted)

Parameter	Symbol	Condition	Min.	Typ.	Max.	Unit
Breakdown Voltage	V _{BR}	I _{BR} = 1 mA	22.8		27.3	V
Leakage Current	I _R	V _{RWM} = 20 V			0.1	μA
ESD Clamping Voltage (Note 1)	V _C	IEC 61000-4-2 +8 kV (I _{TLP} = 16 A)			34	V
Junction Capacitance	C _J	V _R = 0 V, f = 1 MHz		6.5	10	pF

Note 1: ESD Clamping Voltage was measured by a Transmission Line Pulsing (TLP) System. TLP conditions:
Z₀ = 50 Ω, t_p = 100 ns, t_r = 1 ns.

BOURNS®

Asia-Pacific: Tel: +886-2 2562-4117 • Email: asiacus@bourns.com

EMEA: Tel: +36 88 520 390 • Email: eurocus@bourns.com

The Americas: Tel: +1-951 781-5500 • Email: americus@bourns.com

www.bourns.com

*RoHS Directive 2002/95/EC Jan. 27, 2003 including annex and RoHS Recast 2011/65/EU June 8, 2011.

Specifications are subject to change without notice.

The device characteristics and parameters in this data sheet can and do vary in different applications and actual device performance may vary over time. Users should verify actual device performance in their specific applications.

CD0201-T20C - Surface Mount TVS Diode



Performance Graphs

Transmission Line Pulsing

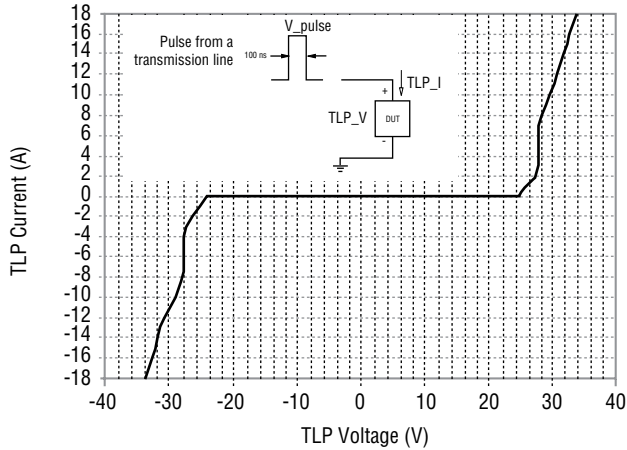

Capacitance

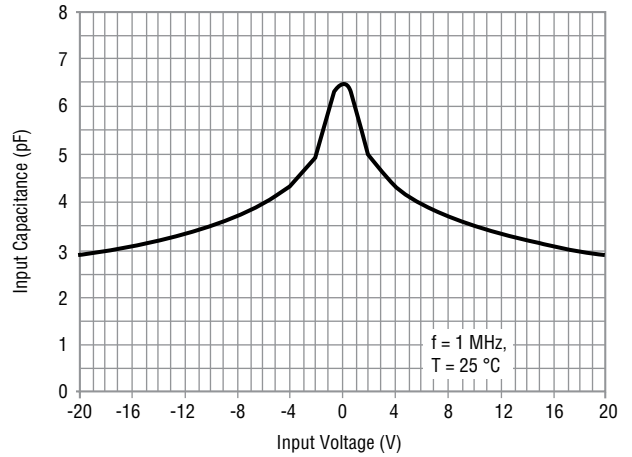

Typical Part Marking

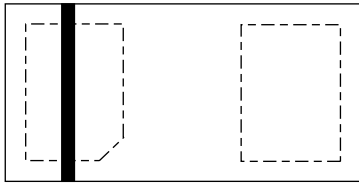

How to Order

CD 0201 - T 20 C

Common Code _____
 Chip Diode _____
 Package _____
 0201 = 0201 Package _____
 Series _____
 T = TVS Diode _____
 Maximum Reverse Working Peak Voltage _____
 20 = 20 V _____
 Suffix _____
 C = Bidirectional Diode _____

Product Dimensions

TOP VIEW

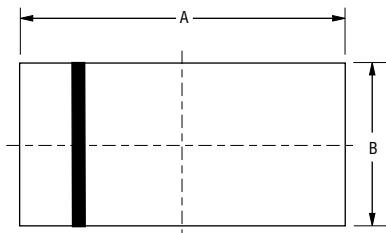

SIDE VIEW

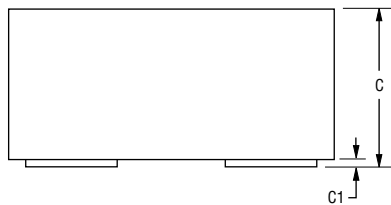

BOTTOM VIEW

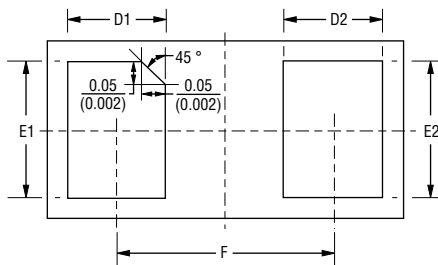

DIMENSIONS: $\frac{\text{MM}}{\text{(INCHES)}}$

Dim.	0201 Package
A	$\frac{0.6 \pm 0.05}{(0.024 \pm 0.002)}$
B	$\frac{0.3 \pm 0.05}{(0.012 \pm 0.002)}$
C	$\frac{0.3 \pm 0.02}{(0.012 \pm 0.001)}$
C1	$\frac{0.025 \pm 0.025}{(0.001 \pm 0.001)}$
D1	$\frac{0.18 \pm 0.05}{(0.007 \pm 0.002)}$
D2	$\frac{0.19 \pm 0.05}{(0.007 \pm 0.002)}$
E1 / E2	$\frac{0.25 \pm 0.05}{(0.01 \pm 0.002)}$
F	$\frac{0.35}{(0.014)}$

Specifications are subject to change without notice.
 The device characteristics and parameters in this data sheet can and do vary in different applications and actual device performance may vary over time.
 Users should verify actual device performance in their specific applications.

CD0201-T20C - Surface Mount TVS Diode

BOURNS®

Recommended PCB Footprint

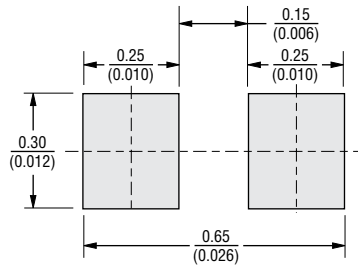

Packaging Information

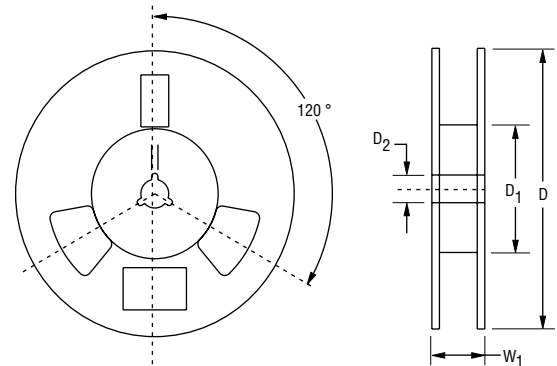
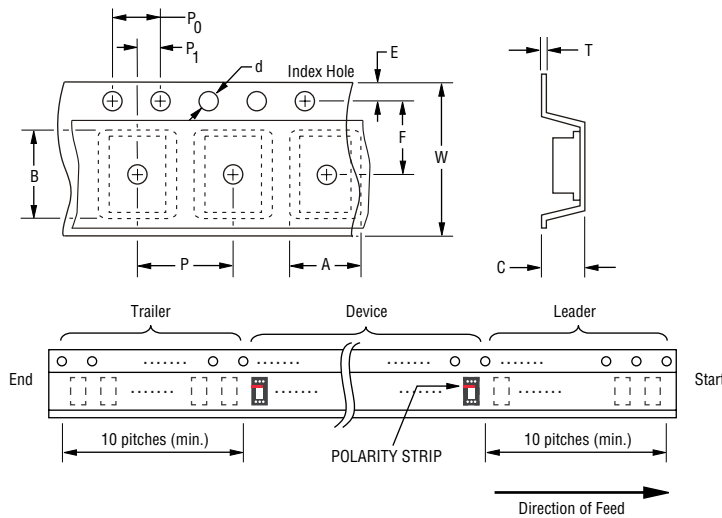

DIMENSIONS: $\frac{\text{MM}}{\text{(INCHES)}}$

Item	Symbol	CD0201-T20C
Carrier Width	A	$\frac{0.36 \pm 0.03}{(0.014 \pm 0.001)}$
Carrier Length	B	$\frac{0.66 \pm 0.03}{(0.026 \pm 0.001)}$
Carrier Depth	C	$\frac{0.33 \pm 0.03}{(0.013 \pm 0.001)}$
Sprocket Hole	d	$\frac{1.5 + 0.1/-0}{(0.059 + 0.004/-0)}$
Reel Outside Diameter	D	$\frac{180 \pm 2}{(7.087 \pm 0.079)}$
Reel Inner Diameter	D ₁	$\frac{50}{(1.969)}$ MIN.
Feed Hole Diameter	D ₂	$\frac{13 + 0.5/-0.2}{(0.512 + 0.02/-0.008)}$
Sprocket Hole Position	E	$\frac{1.75 \pm 0.10}{(0.069 \pm 0.004)}$

Item	Symbol	CD0201-T20C
Punch Hole Position	F	$\frac{3.5 \pm 0.05}{(0.138 \pm 0.002)}$
Punch Hole Pitch	P	$\frac{2.0 \pm 0.10}{(0.079 \pm 0.004)}$
Sprocket Hole Pitch	P ₀	$\frac{4.0 \pm 0.10}{(0.157 \pm 0.004)}$
Embossment Center	P ₁	$\frac{2.0 \pm 0.05}{(0.079 \pm 0.002)}$
Overall Tape Thickness	T	$\frac{0.23 \pm 0.02}{(0.009 \pm 0.001)}$
Tape Width	W	$\frac{8.0 \pm 0.10}{(0.315 \pm 0.004)}$
Reel Width	W ₁	$\frac{14.4}{(0.567)}$ MAX.
Quantity per Reel	--	12,000

11/15/16

Specifications are subject to change without notice.
The device characteristics and parameters in this data sheet can
and do vary in different applications and actual device performance may vary over time.
Users should verify actual device performance in their specific applications.