

Extrusion

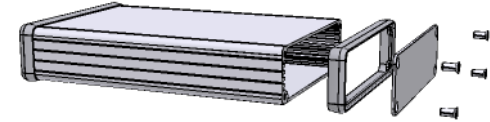

EXTRUSION DESIGNED FOR 100MM WIDE PC BOARD

Slot Details

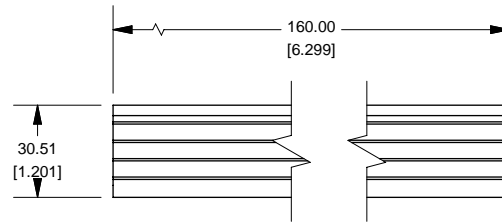
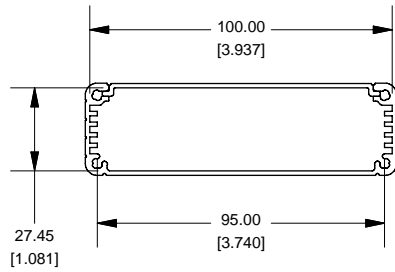
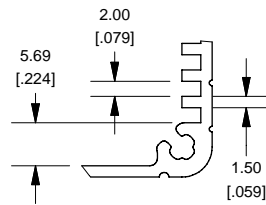

End Plate

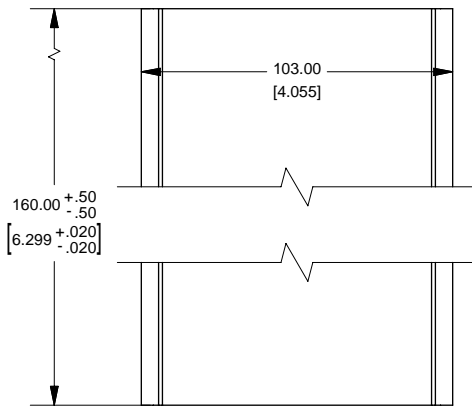
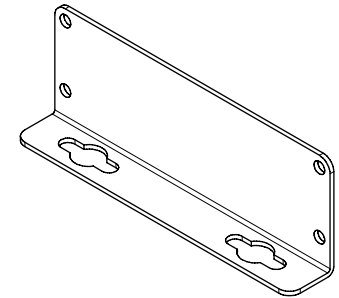
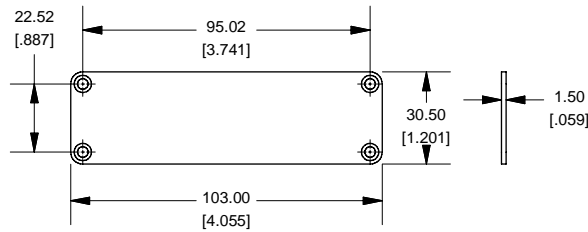

Open Bezel

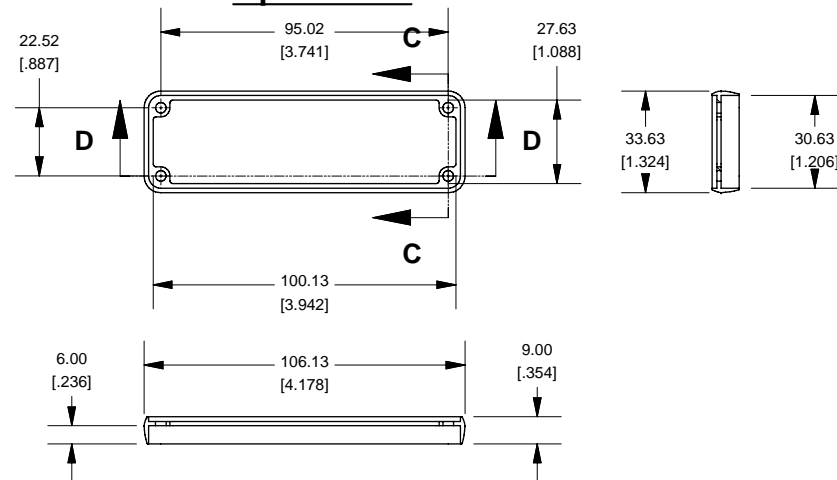

OPTIONAL FLANGE END PANELS 1455LF

NOTE	
Purchased assembly includes box, plastic bezels, end panels, #6 Taptight screws and self adhesive rubber feet.	
Box made from Extruded Aluminum 6063.	
Bezels made with polycarbonate.	

1455L1601	
PART NUMBERS	
Clear Anodized	1455L1601
Black Anodized	1455L1601BK
ACCESSORIES	
See website for accessories.	



Enclosures can be Factory Modified (Milling, Drilling, Printing etc.)
Solid models of this enclosure available in STEP or IGES.
Contact Factory mjm@hammondmfg.com