



## ESSENTIAL INFORMATION

BUILD INSTRUCTIONS  
CHECKING YOUR PCB & FAULT-FINDING  
MECHANICAL DETAILS  
HOW THE KIT WORKS

TIME SOMETHING WITH THIS

# TIMER PROJECT KIT

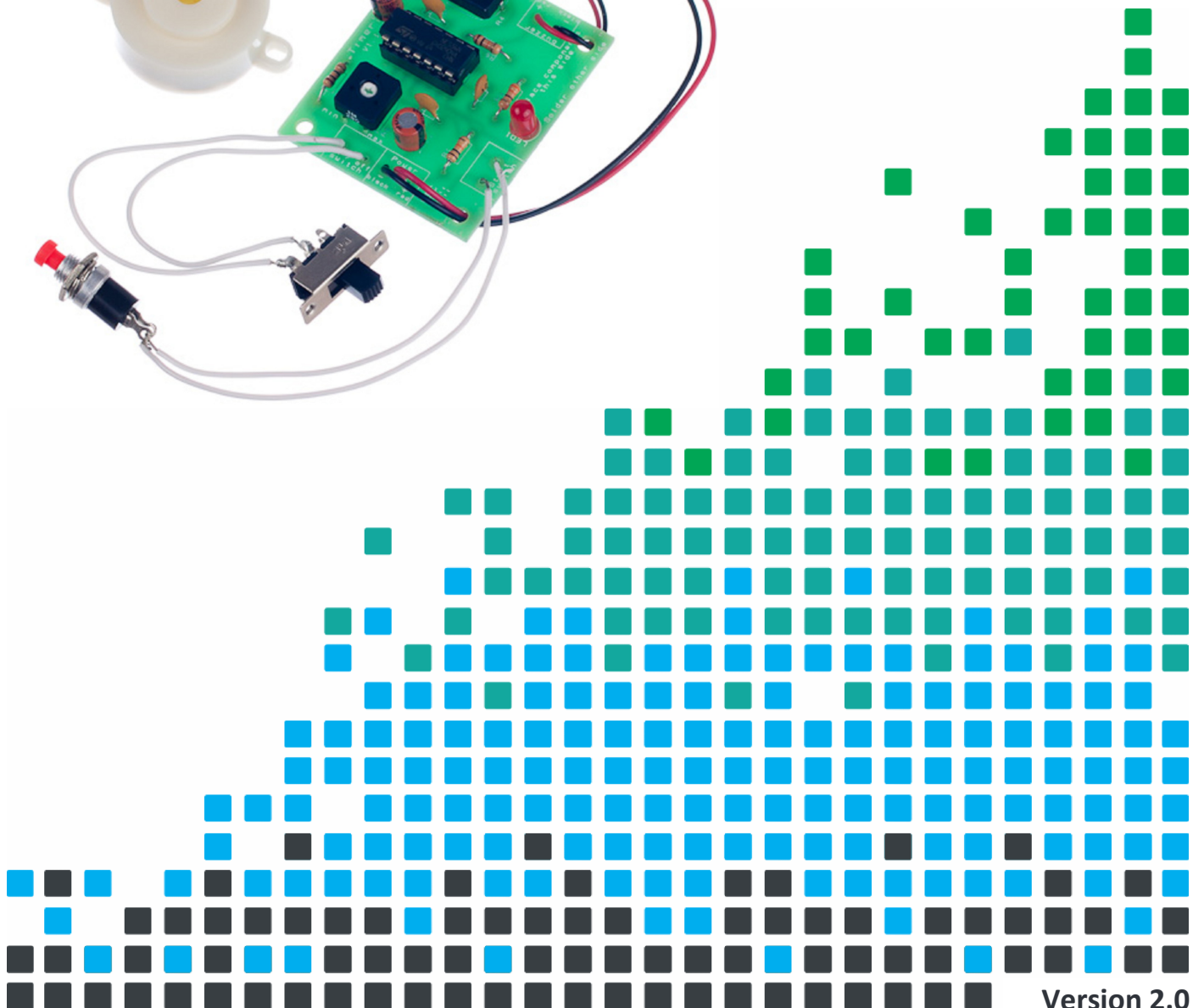
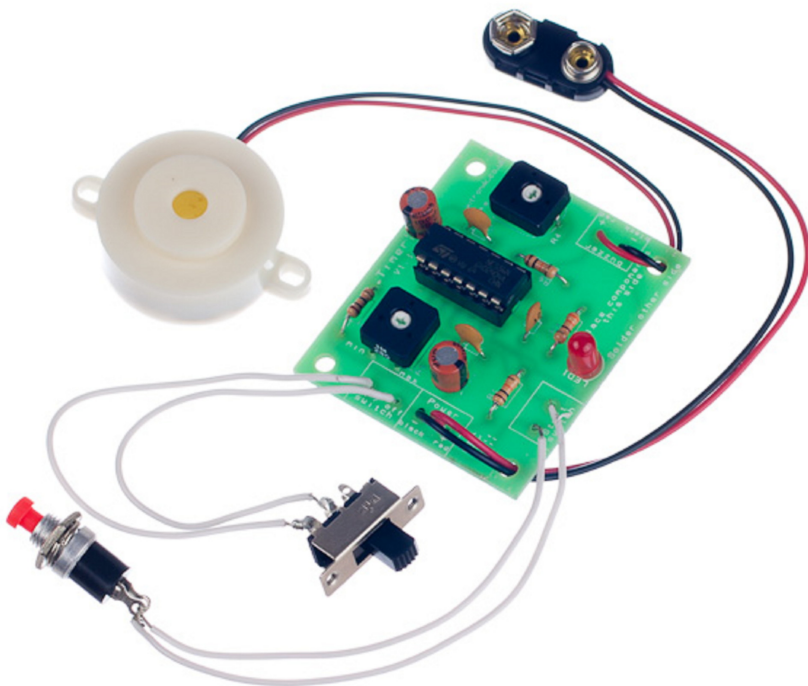

Version 2.0

## Build Instructions

Before you start, take a look at the Printed Circuit Board (PCB). The components go in the side with the writing on and the solder goes on the side with the tracks and silver pads.

### 1 PLACE THE RESISTORS

Start with the resistors:

The text on the PCB shows where R1, R2 etc go.

Ensure that you put the resistors in the right place.

| PCB Ref | Value        | Colour Bands          |
|---------|--------------|-----------------------|
| R1 & R6 | 10K $\Omega$ | Brown, black, orange  |
| R3      | 330 $\Omega$ | Orange, orange, brown |
| R2      | 1M $\Omega$  | Brown, black, green   |

Fit R2 if you want your timer to have a time out period between 100 and 200 seconds.

Fit a wire link if you want the timer to last less than 100 seconds.



### 2 Place the potentiometers

There are two variable potentiometers. One is 1M $\Omega$  and the other 100k $\Omega$ . They are clearly marked on the side of the housing.

Solder the 100k $\Omega$  variable potentiometer into R4 on the PCB.

Solder the 1M $\Omega$  variable potentiometer into R5 on the PCB.



### 3 Place the ceramic capacitors

Solder the three ceramic capacitors in to C1, C2 and C3. They can go in either position as they are all the same.



### 4 Place the electrolytic capacitors

Solder the two electrolytic capacitors in to C4 and C5. They can go in either position but it is important that the '-' on the capacitor line up with the ---- markings on the PCB.

**Using an electrolytic capacitor backwards could result in it being destroyed.**

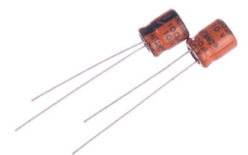

### 5 Place the IC holder

Solder the Integrated Circuit (IC) holder in to U1. When putting this into the board, be sure to get it the right way around. The notch on the IC holder should line up with the notch on the lines marked on the PCB.



# Timer Project Kit Essential Information



[www.kitronik.co.uk/2104](http://www.kitronik.co.uk/2104)

## 6 Place the LED

Solder the Light Emitting Diode (LED) in to LED1. The timer won't work if it doesn't go in the right way around. If you look carefully one side of the LED has a flat edge, which must line up with the flat edge on the lines on the PCB.



## 7 Place the buzzer

The buzzer should be soldered into the 'buzzer' terminal. The red wire must go to the + terminal and the black wire must go to the – terminal.



## 8 Connect the battery connector

The battery connector should be soldered into the 'Power' terminal. The red wire must go to the + terminal and the black wire must go to the – terminal.



## 9 Connect the on/off switch

Cut and strip two pieces of wire to the required length for connecting to the on/off switch. Solder one end of each wire to an edge and the center terminals (both connections on the same row) on the switch and the other end to the terminals labeled 'On/Off switch'. It does not matter which wire goes to which terminal.

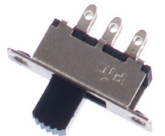

## 10 Connect the timer switch

Cut and strip two pieces of wire to the required length for connecting to the timer start switch. Solder one end of each wire to each of the terminals on the switch and the other end to the terminals labeled 'Start Switch'. It does not matter which wire goes to which terminal.



## 11 Connect the IC

The IC can be put into the holder ensuring the notch on the chip lines up with the notch on the holder.



## Checking Your Timer PCB

Check the following before you insert the batteries:

Check the bottom of the board to ensure that:

- All holes (except the 4 large 3 mm holes) are filled with the lead of a component.
- All these leads are soldered.
- Pins next to each other are not soldered together.

Check the top of the board to ensure that:

- The notch on the IC and the IC holder are in the same orientation as the markings on the printed circuit board.
- You are confident that all the resistors are in the correct places.
- The red wire on the battery connector goes to the + terminal on the power terminals and the black wire goes to the – terminal.
- The red wire on the buzzer goes to the + terminal on the buzzer terminals and the black wire goes to the – terminal.
- The LED is in the right way around.

## Testing the PCB

The circuit has been designed to allow easy testing of the PCB.

Turn both the potentiometers to minimum and then back slightly towards max (Almost fully anti-clockwise – as marked 'min' on your PCB). Then insert the batteries with the power switch in the on position.

- The timer may illuminate LED1 or / and sound the buzzer for a period of time.
  - If this is the case, just wait for the LED to go out and the buzzer to stop, before testing as follows:
- Press the start button and check again that the LED lights for a period and when the LED goes out the buzzer sounds for a period.
- Check that R5 can be used to adjust the time out period and that R4 can be used to adjust the period for which the buzzer sounds.
- Turn the timer off using the on/off switch.

If you have problems with any of the above use the fault finding flow charts to find the cause of the fault.



## Fault finding flow chart - page 1

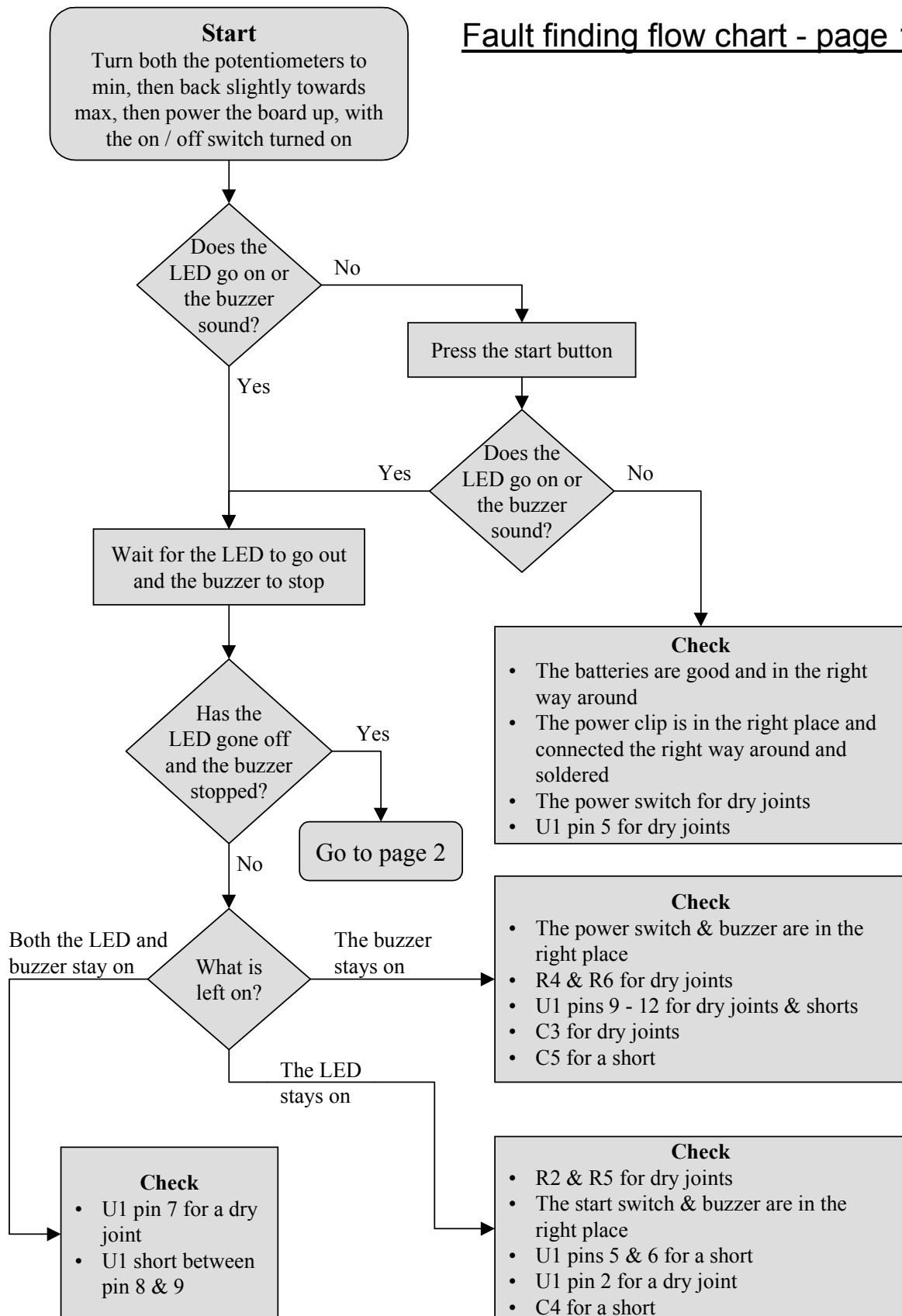

## Fault finding flow chart page 2

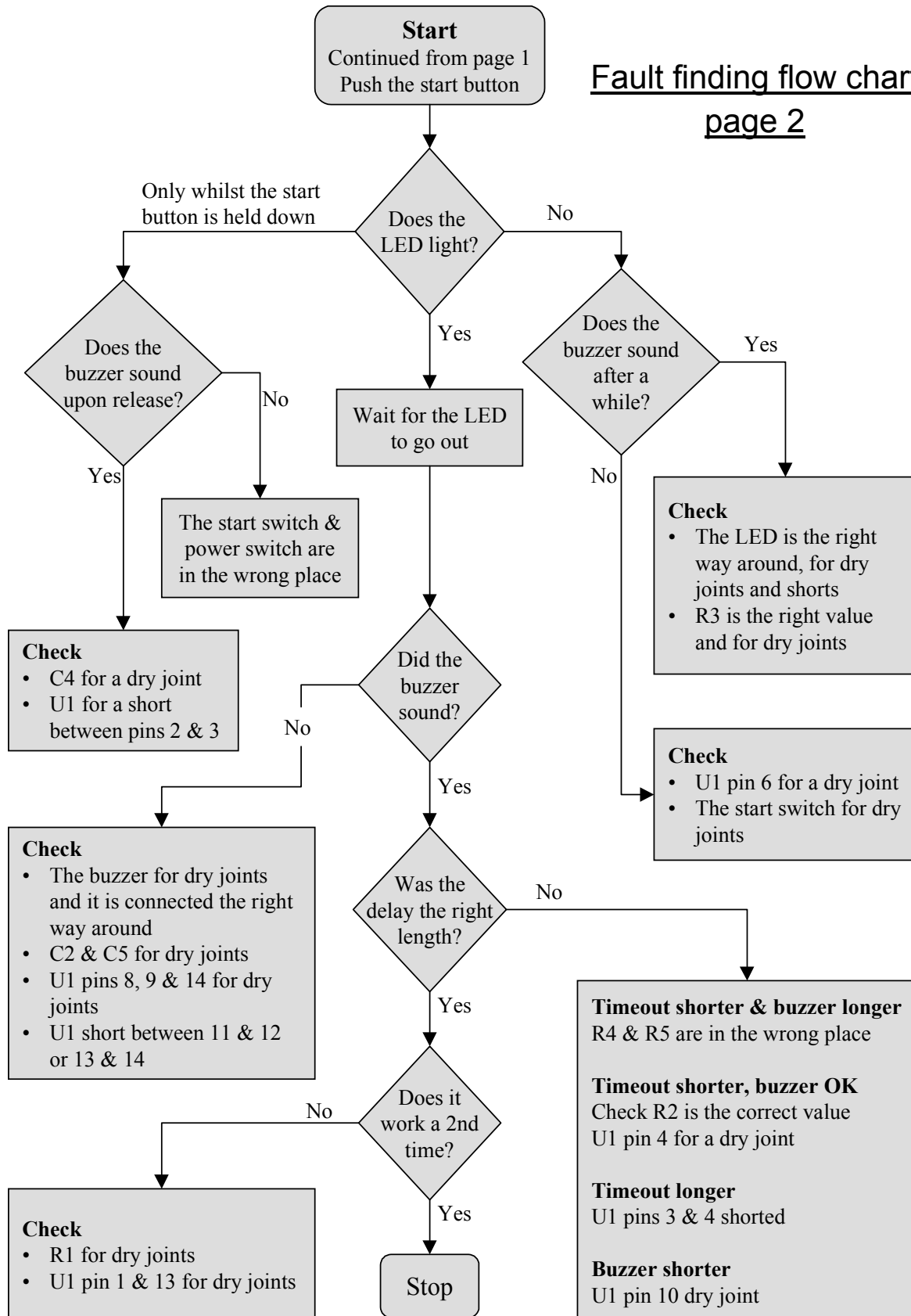

## Designing the Enclosure

When you design the enclosure, you will need to consider:

- The size of the PCB (right)
- Where the start switch will be (below right)
- Where the on/off switch will be (below left)
- Where the buzzer will be mounted (below centre)
- Where the LED will be mounted (5mm diameter)
- Access to the batteries to allow them to be changed (bottom right)

These technical drawings of all of these items are illustrated on this page, which should help you design your enclosure.

All dimensions are in mm.

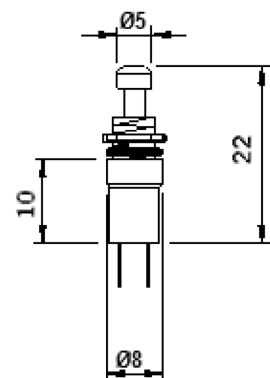
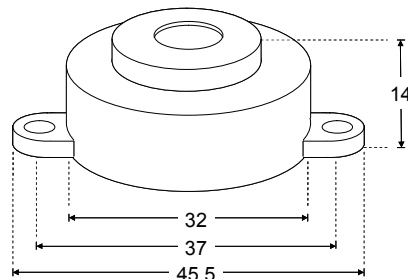
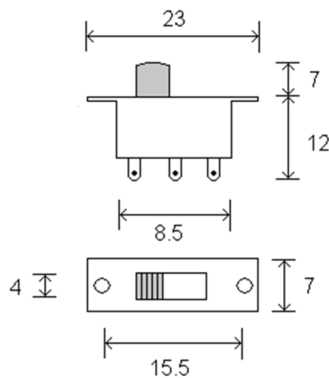
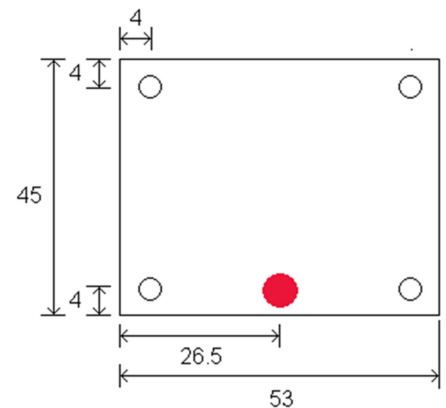

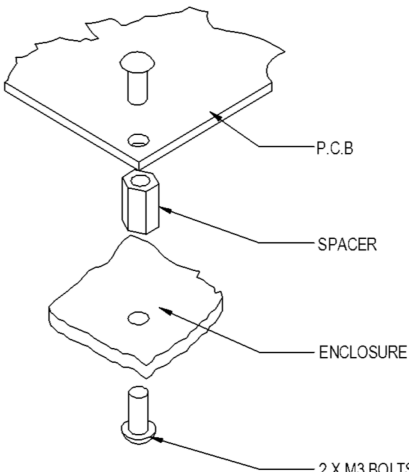

**Mounting the PCB to the enclosure**

The drawing to the left shows how a hex spacer can be used with two bolts to fix the PCB to the enclosure.

*Your PCB has four mounting holes designed to take M3 bolts.*

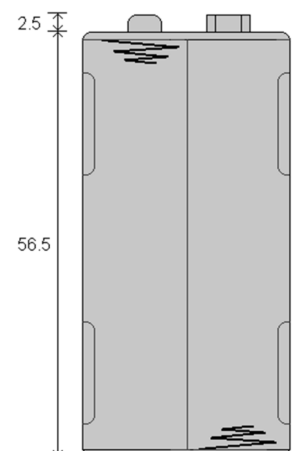
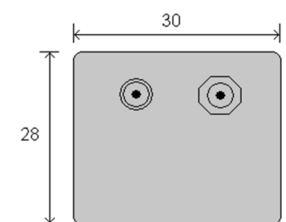

## How the timer works

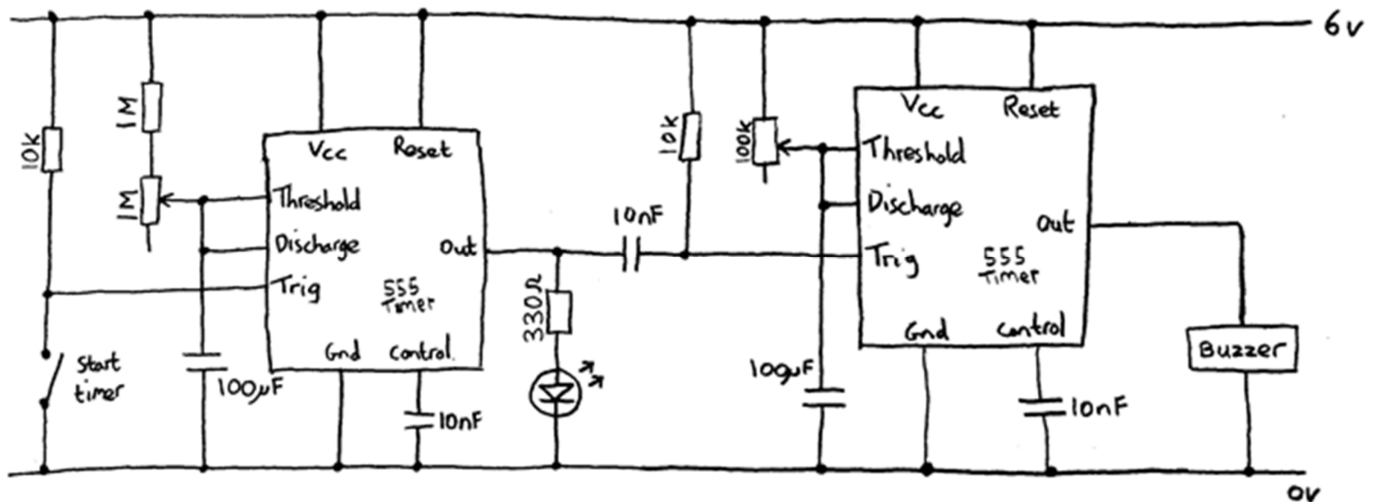

The timer is based around the 556 timer. This is simply two 555 timers in the same device.

The 555 timer is a versatile IC (integrated circuit) and can be used to form many circuits. One of these circuits is a monostable timer. This circuit produces a single pulse when triggered. This means the Out pin is high (causing the LED to light or buzzer to sound).

To trigger the circuit the Trig input must go from a high to a low voltage. When the start switch is pressed (closed) the Trig input is taken low and the output pulse starts.

The duration of the pulse generated is determined by the RC constant (see Capacitor worksheet) formed by the resistor and capacitor connected to the Threshold input. When triggered the Discharge pin is used to start the 100µF cap charging. When it reaches 2/3 of the battery voltage the Out pin changes from high to low.

The first 555 timer is used to provide the timing delay, which is the time you have to before the buzzer is sounded. This can be adjusted between 0 seconds and 200 seconds. This is because R5, the variable 1MΩ can be adjusted between 1MΩ and 0Ω and an additional 1MΩ resistor can be added. This gives a maximum RC constant of 100µF x 2MΩ (1MΩ+1MΩ) = 200 seconds and a minimum of 100µF x 0MΩ (0MΩ+0Ω) = 0 seconds.

When this times out the output goes low and causes the second 555 timer circuit to start and the LED to go out. At this point the buzzer will begin to sound. The second timer and therefore the period for which the buzzer sounds can be adjusted to between 0 seconds and 10 seconds (100µF x 100KΩ = 10 seconds).





## Using the Timer

- Insert four batteries into the battery holder
- Turn the timer on using the on / off switch
- To start the timer press the start switch
- Follow the steps below if you want to adjust the time out period or the buzzer length
- Don't forget to switch the timer off when not being used, otherwise you will flatten the batteries

### ***Adjusting the time out period***

- The time out period can be adjusted in length. To make it shorter turn R5 in anti-clockwise direction or to make it sound for longer turn R5 in the clockwise direction

### ***Adjusting the buzzer length***

- The period for which the buzzer sounds can be adjusted in length. To make it sound for less time turn R4 in the anti-clockwise direction or to make it sound for longer turn R4 in the clockwise direction



## Online Information

Two sets of information can be downloaded from the product page where the kit can also be reordered from. The 'Essential Information' contains all of the information that you need to get started with the kit and the 'Teaching Resources' contains more information on soldering, components used in the kit, educational schemes of work and so on and also includes the essentials. Download from:

[www.kitronik.co.uk/2104](http://www.kitronik.co.uk/2104)



This kit is designed and manufactured in the UK by Kitronik

---

**Telephone:** +44 (0) 845 8380781

**Sales email:** sales@kitronik.co.uk

**Tech support email:** support@kitronik.co.uk

**Web:** www.kitronik.co.uk



www.kitronik.co.uk/twitter



www.kitronik.co.uk/facebook



www.kitronik.co.uk/youtube



www.kitronik.co.uk/google

---

Every effort has been made to ensure that these notes are correct, however Kitronik accept no responsibility for issues arising from errors / omissions in the notes.

© Kitronik Ltd - Any unauthorised copying / duplication of this booklet or part thereof for purposes except for use with Kitronik project kits is not allowed without Kitronik's prior consent.