

## Technical Data Sheet (Preliminary)

### Surface Mount Device (Power Top View LED)

#### 67-31A/RSC-AV1W2B9Z5/2T

#### Features

- PLCC-3 package.
- High flux output.
- High current capability.
- White package.
- Optical indicator.
- Colorless clear window.
- Ideal for backlight and light pipe application.
- Inter reflector.
- Wide viewing angle.
- Suitable for automatic placement equipment.
- Suitable for reflow and wave solder processes.
- Available on tape and reel (8mm Tape).
- Pb-free.
- The product itself will remain within RoHS compliant version.



#### Descriptions

The 67-31A series is available in soft orange, red and yellow. Due to the package design, the LED has wide viewing angle and optimized light coupling by inter reflector.

This feature makes the ideal for light pipe application. The low current requirement makes this device ideal for portable equipment or any other application where power is at a premium.

#### Applications

- Indicator and backlight for audio and video equipment.
- Indicator and backlight in office and family equipment.
- Flat backlight for LCD's, switches and symbols.
- Light pipe application.
- General use.

#### Device Selection Guide

Chip		Lens Color
Material	Emitted Color	
AlGaInP	Brilliant Red	Water Clear

**67-31A/RSC-AV1W2B9Z5/2T**

**Package Dimensions**

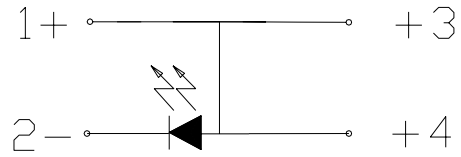
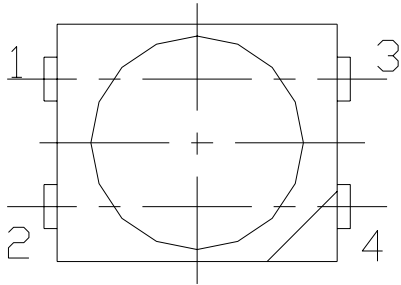

Polarity

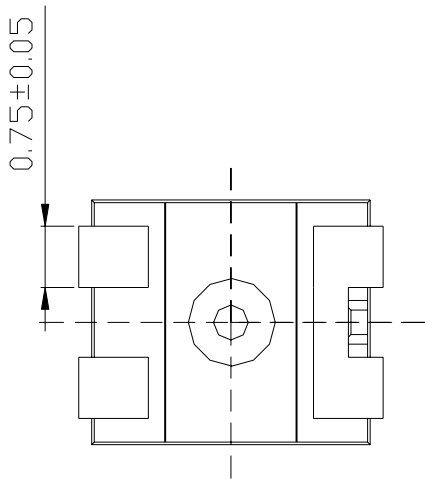
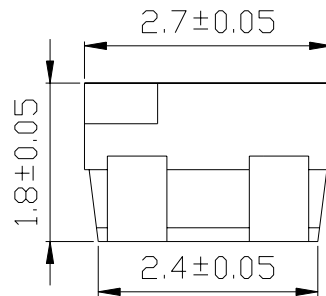
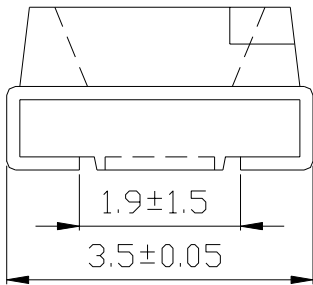

for reflow  
soldering (propose)

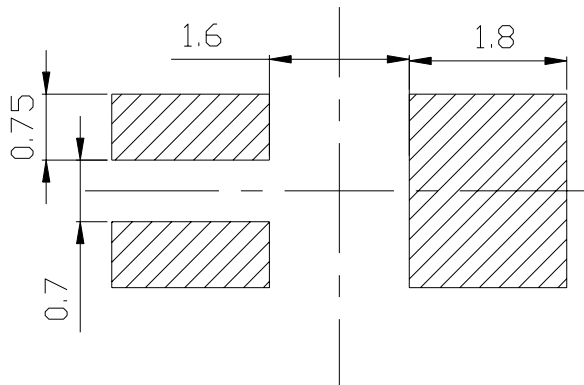

**Note: The tolerances unless mentioned is  $\pm 0.1\text{mm}$  ;Unit = mm**

**67-31A/RSC-AV1W2B9Z5/2T**
**Absolute Maximum Ratings ( $T_A=25^{\circ}\text{C}$ )**

Parameter	Symbol	Rating	Unit
Reverse Voltage	$V_R$	5	V
Forward Current	$I_F$	70	mA
Operating Temperature	$T_{opr}$	-40 ~ +85	$^{\circ}\text{C}$
Storage Temperature	$T_{stg}$	-40 ~ +100	$^{\circ}\text{C}$
Electrostatic Discharge(HBM)	ESD	2000	V
Power Dissipation	$P_d$	220	mW
Peak Forward Current (Duty 1/10 @ 1KHz)	$I_{FP}$	150	mA
Soldering Temperature	$T_{sol}$	Reflow Soldering : 260 $^{\circ}\text{C}$ for 10 sec. Hand Soldering : 350 $^{\circ}\text{C}$ for 3 sec.	

**Electronic Optical Characteristics :**

Parameter	Symbol	Min.	Typ.	Max.	Unit	Condition
Luminous Intensity	$I_v$	715	-----	1800	mcd	$I_F=50\text{mA}$
Viewing Angle	$2\theta_{1/2}$	-----	120	-----	deg	$I_F=50\text{mA}$
Peak Wavelength	$\lambda_p$	-----	632	-----	nm	$I_F=50\text{mA}$
Dominant Wavelength	$\lambda_d$	617.5	-----	633.5	nm	$I_F=50\text{mA}$
Spectrum Radiation Bandwidth	$\Delta\lambda$	-----	20	-----	nm	$I_F=50\text{mA}$
Forward Voltage	$V_F$	2.15	-----	2.75	V	$I_F=50\text{mA}$
Reverse Current	$I_R$	-----	-----	10	$\mu\text{A}$	$V_R=5\text{V}$

**Notes:**

- 1.Tolerance of Luminous Intensity  $\pm 10\%$**
- 2.Tolerance of Dominant Wavelength  $\pm 1\text{nm}$**
- 3.Tolerance of Forward Voltage  $\pm 0.1\text{V}$**

**67-31A/RSC-AV1W2B9Z5/2T**

**Bin Range Of Dominant Wavelengths**

Group	Bin Code	Min.	Max.	Unit	Condition
A	E4	617.5	621.5	nm	I <sub>F</sub> =50mA
	E5	621.5	625.5		
	E6	625.5	629.5		
	E7	629.5	633.5		

**Bin Range Of Luminous Intensity**

Bin	Min	Max	Unit	Condition
V1	715	900	mcd	I <sub>F</sub> =50mA
V2	900	1120		
W1	1120	1420		
W2	1420	1800		

**Bin Range Of Forward Voltage**

Group	Bin	Min	Max	Unit	Condition
B9	2	2.15	2.35	V	I <sub>F</sub> =50mA
	3	2.35	2.55		
	4	2.55	2.75		

**Notes:**

- 1.Tolerance of Luminous Intensity  $\pm 10\%$
- 2.Tolerance of Dominant Wavelength  $\pm 1\text{nm}$
- 3.Tolerance of Forward Voltage  $\pm 0.1\text{V}$

**67-31A/RSC-AV1W2B9Z5/2T**

**Typical Electro-Optical Characteristic Curves**

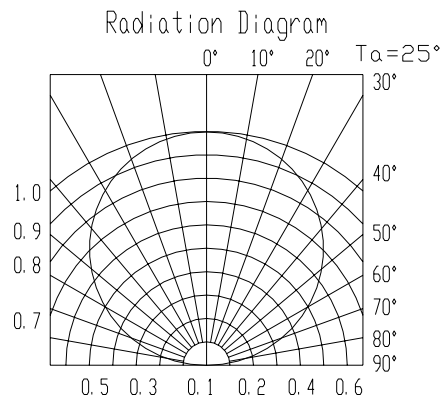
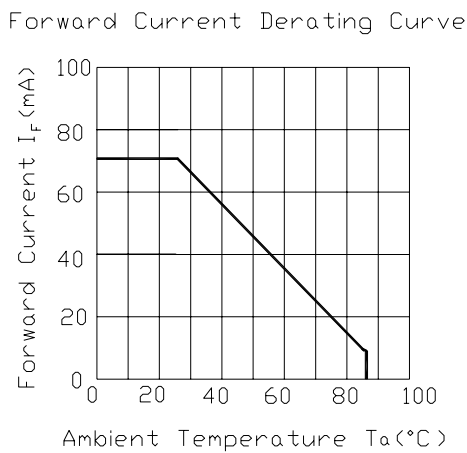
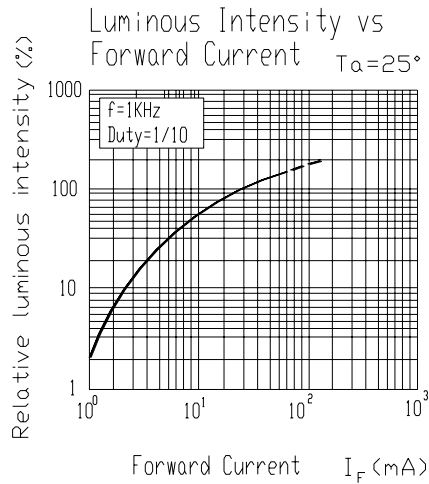
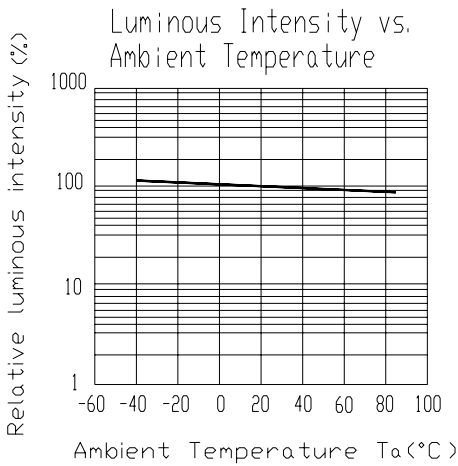
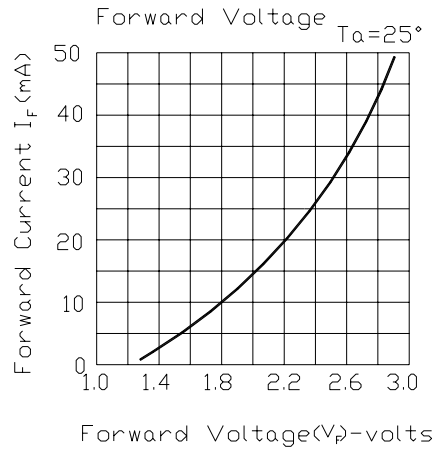
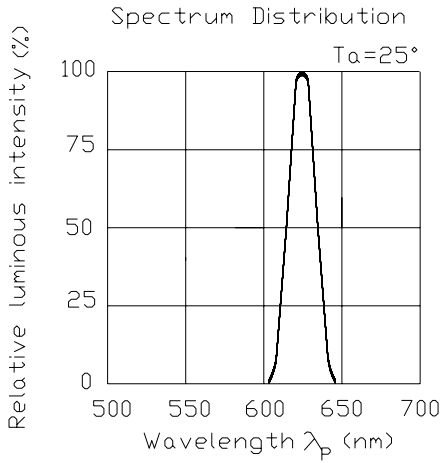

**67-31A/RSC-AV1W2B9Z5/2T**

**Label explanation**

**CAT: Luminous Intensity Rank**

**HUE: Dom. Wavelength Rank**

**REF: Forward Voltage Rank**

EVERLIGHT



CPN: XXXXXX  
P/N: XXXXXX



RoHS

XXXXXXXXXXXXXXXXXXXX  
QTY: XXXX

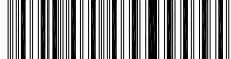

CAT:  
HUE:  
REF:

LOT NO: XXXXXXXXXXXX

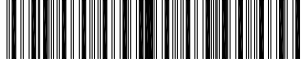

MADE IN TAIWAN

**Reel Dimensions**

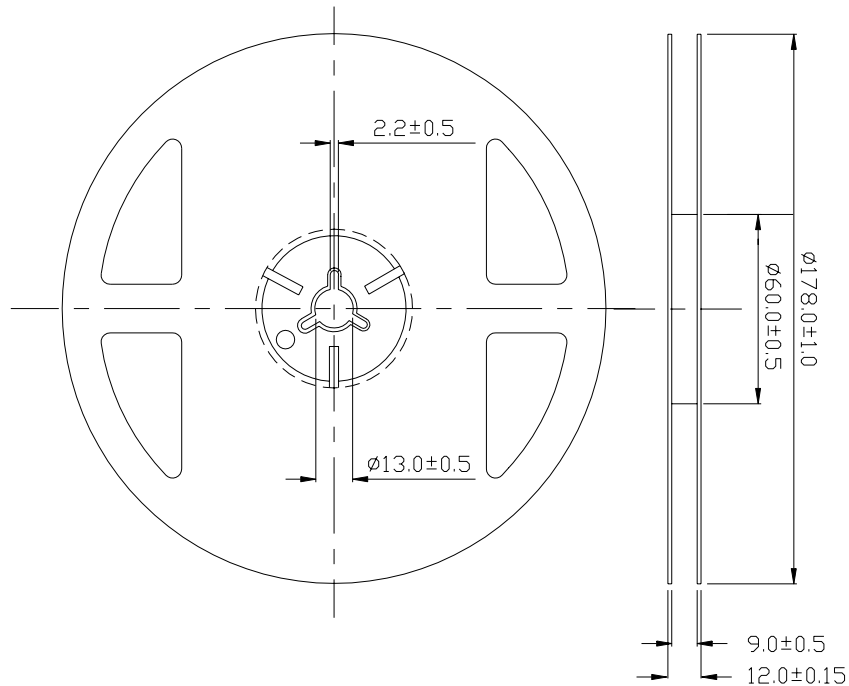

**Note:** The tolerances unless mentioned is  $\pm 0.1$ mm, Unit = mm

**Carrier Tape Dimensions; Loaded quantity per reel 2000 PCS/reel**

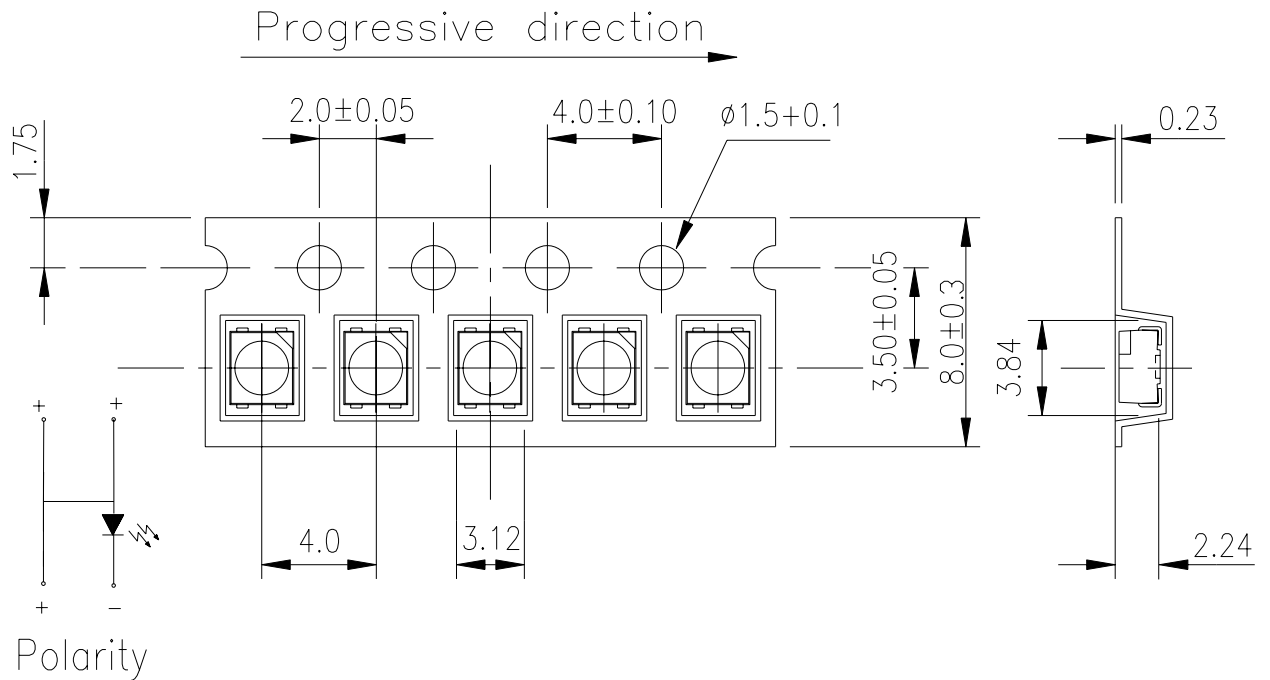

**Note:** Tolerances Unless Dimension  $\pm 0.1\text{mm}$  Unit = mm

**Moisture Resistant Packaging**

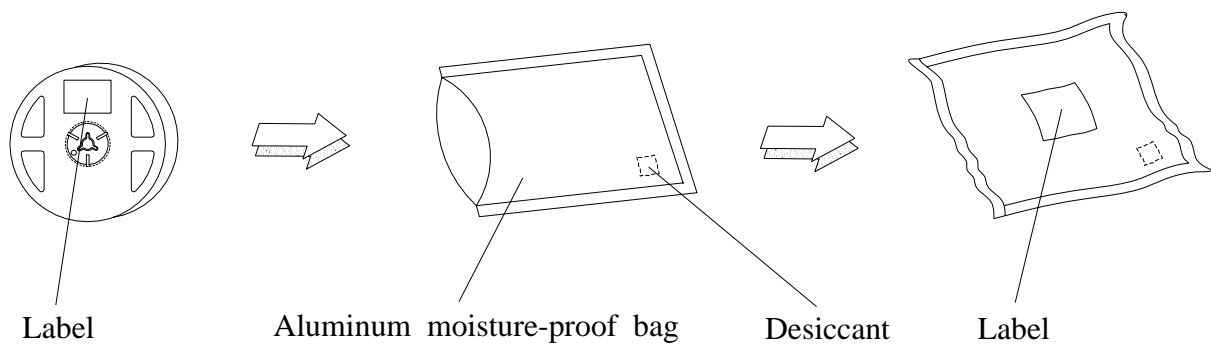

**67-31A/RSC-AV1W2B9Z5/2T**

**Reliability Test Items And Conditions**

The reliability of products shall be satisfied with items listed below.

Confidence level : 90%

LTPD : 10%

No.	Items	Test Condition	Test Hours/Cycles	Sample Size	Ac/Re
1	Reflow Soldering	Temp. : 260°C ±5°C Min. 5 sec.	6 Min.	22 PCS	0/1
2	Temperature Cycle	H : +100°C 15min ∫ 5 min L : -40°C 15min	300 Cycles	22 PCS.	0/1
3	Thermal Shock	H : +100°C 5min ∫ 10 sec L : -10°C 5min	300 Cycles	22 PCS.	0/1
4	High Temperature Storage	Temp. : 100°C	1000 Hrs.	22 PCS.	0/1
5	Low Temperature Storage	Temp. : -40°C	1000 Hrs.	22 PCS.	0/1
6	DC Operating Life	I <sub>F</sub> = 20 mA / 25°C	1000 Hrs.	22 PCS.	0/1
7	High Temperature / High Humidity	85°C/85%RH	1000 Hrs.	22 PCS.	0/1



## Precautions For Use

### 1. Over-current-proof

Customer must apply resistors for protection, otherwise slight voltage shift will cause big current change ( Burn out will happen ).

### 2. Storage

2.1 Do not open moisture proof bag before the products are ready to use.

2.2 Before opening the package: The LEDs should be kept at 30°C or less and 90%RH or less.

2.3 After opening the package: The LED's floor life is 1 year under 30 deg C or less and 60% RH or less.

If unused LEDs remain, it should be stored in moisture proof packages.

2.4 If the moisture absorbent material (silica gel) has faded away or the LEDs have exceeded the storage time, baking treatment should be performed using the following conditions.

Baking treatment : 60±5°C for 24 hours.

### 3. Soldering Condition

#### 3.1 Pb-free solder temperature profile

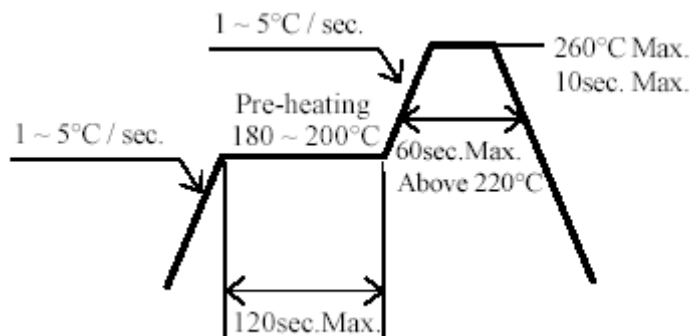

3.2 Reflow soldering should not be done more than two times.

3.3 When soldering, do not put stress on the LEDs during heating.

3.4 After soldering, do not warp the circuit board.

#### 4. Soldering Iron

Each terminal is to go to the tip of soldering iron temperature less than 350°C for 3 seconds within once in less than the soldering iron capacity 25W. Leave two seconds and more intervals, and do soldering of each terminal. Be careful because the damage of the product is often started at the time of the hand solder.

**5.Repairing**

Repair should not be done after the LEDs have been soldered. When repairing is unavoidable, a double-head soldering iron should be used (as below figure). It should be confirmed beforehand whether the characteristics of the LEDs will or will not be damaged by repairing.

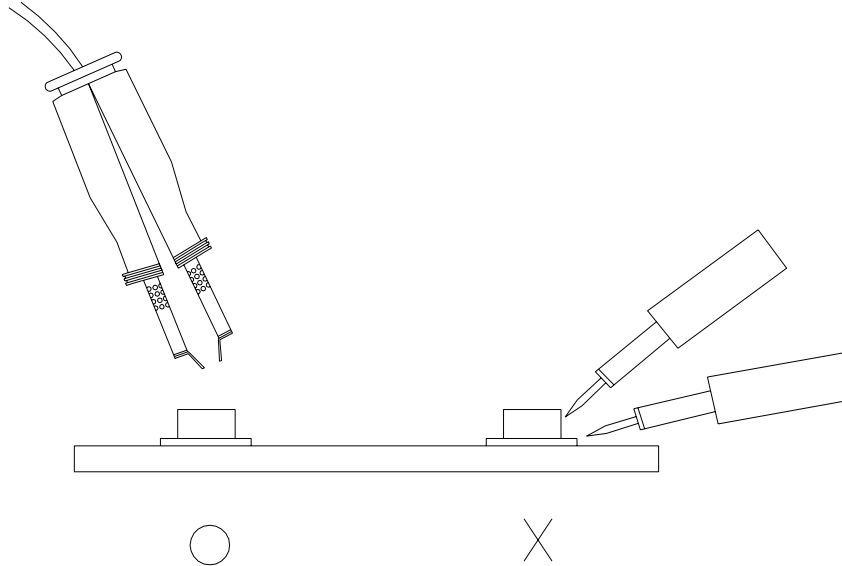

**EVERLIGHT ELECTRONICS CO., LTD.**  
Office: No 25, Lane 76, Sec 3, Chung Yang Rd,  
Tucheng, Taipei 236, Taiwan, R.O.C

Tel: 886-2-2267-2000, 2267-9936  
Fax: 886-2267-6244, 2267-6189, 2267-6306  
<http://www.everlight.com>