



# i110-PA223

i110P

**ELECTRO-MECHANICAL SAFETY SWITCHES**

**SICK**  
Sensor Intelligence.



### Ordering information

Type	Part no.
i110-PA223	6025105

Other models and accessories → [www.sick.com/i110P](http://www.sick.com/i110P)



### Detailed technical data

#### Features

<b>Number of positive action N/C contacts</b>	2
<b>Number of N/O contacts</b>	2
<b>Actuation force</b>	≥ 11 N
<b>Actuation frequency</b>	≤ 6,000 /h
<b>Actuation directions</b>	4
<b>Approach speed</b>	0.1 m/min ... 15 m/min
<b>Positive break travel</b>	4 mm

#### Safety-related parameters

<b>B<sub>10d</sub> parameter</b>	2 x 10 <sup>6</sup> switching cycles (with small load)
<b>Type</b>	Type 1 (EN ISO 14119)
<b>Actuator coding level</b>	Uncoded (EN ISO 14119)
<b>Safe state in the event of a fault</b>	The switch has no internal fault detection and is unable to assume a safe state in the event of a fault. Fault detection is performed by the connected safety-related logic unit.

#### Interfaces

<b>Connection type</b>	Cable gland, 1 x M20
Conductor cross-section	≤ 2.5 mm <sup>2</sup>

#### Electrical data

<b>Switching principle</b>	Slow action switching element
<b>Usage category</b>	AC-15/DC-13 (IEC 60947-5-1)
<b>Rated operating current (voltage)</b>	3 A (240 V AC) 3 A (24 V DC)
<b>Rated insulation voltage U<sub>i</sub></b>	250 V
<b>Rated impulse withstand voltage U<sub>imp</sub></b>	2,500 V AC
<b>Short-circuit protection</b>	F15
<b>Switching voltage</b>	≥ 5 V DC
<b>Switching current (switching voltage)</b>	≥ 5 mA (5 V DC)

## Mechanical data

<b>Weight</b>	0.43 kg
<b>Housing material</b>	Zinc diecast
<b>Surface treatment</b>	Varnished
<b>Mechanical life</b>	10 x 10 <sup>6</sup> switching cycles

## Ambient data

<b>Enclosure rating</b>	IP66 (IEC 60529)
<b>Ambient operating temperature</b>	-25 °C ... +80 °C
<b>Storage temperature</b>	-25 °C ... +80 °C
<b>Vibration resistance</b>	10 Hz ... 5 Hz, 0.35 mm (IEC 68-2-6)

## Classifications

<b>ECI@ss 5.0</b>	27272601
<b>ECI@ss 5.1.4</b>	27272601
<b>ECI@ss 6.0</b>	27272601
<b>ECI@ss 6.2</b>	27272601
<b>ECI@ss 7.0</b>	27272601
<b>ECI@ss 8.0</b>	27272601
<b>ECI@ss 8.1</b>	27272601
<b>ECI@ss 9.0</b>	27272601
<b>ETIM 5.0</b>	EC001829
<b>ETIM 6.0</b>	EC001829
<b>UNSPSC 16.0901</b>	39122205

## Dimensional drawing (Dimensions in mm (inch))

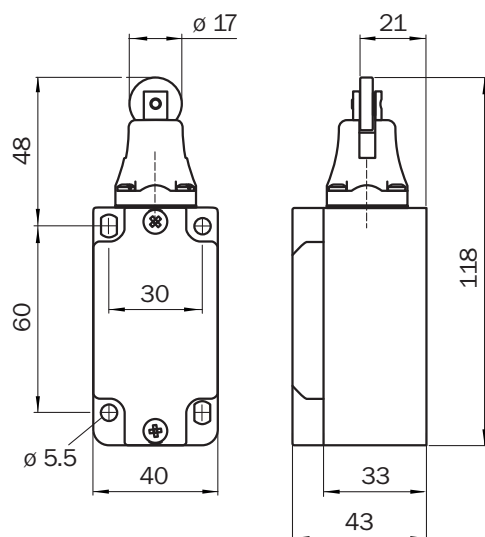

Actuator travel diagram

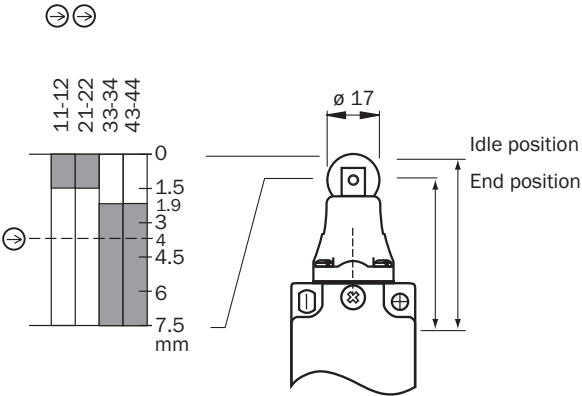

- Contacts open
- Contacts closed

## SICK AT A GLANCE

SICK is one of the leading manufacturers of intelligent sensors and sensor solutions for industrial applications. A unique range of products and services creates the perfect basis for controlling processes securely and efficiently, protecting individuals from accidents and preventing damage to the environment.

We have extensive experience in a wide range of industries and understand their processes and requirements. With intelligent sensors, we can deliver exactly what our customers need. In application centers in Europe, Asia and North America, system solutions are tested and optimized in accordance with customer specifications. All this makes us a reliable supplier and development partner.

Comprehensive services complete our offering: SICK LifeTime Services provide support throughout the machine life cycle and ensure safety and productivity.

For us, that is “Sensor Intelligence.”

## WORLDWIDE PRESENCE:

Contacts and other locations –[www.sick.com](http://www.sick.com)