

To our customers,

Old Company Name in Catalogs and Other Documents

On April 1st, 2010, NEC Electronics Corporation merged with Renesas Technology Corporation, and Renesas Electronics Corporation took over all the business of both companies. Therefore, although the old company name remains in this document, it is a valid Renesas Electronics document. We appreciate your understanding.

Renesas Electronics website: <http://www.renesas.com>

April 1st, 2010
Renesas Electronics Corporation

Issued by: Renesas Electronics Corporation (<http://www.renesas.com>)

Send any inquiries to <http://www.renesas.com/inquiry>.

Notice

1. All information included in this document is current as of the date this document is issued. Such information, however, is subject to change without any prior notice. Before purchasing or using any Renesas Electronics products listed herein, please confirm the latest product information with a Renesas Electronics sales office. Also, please pay regular and careful attention to additional and different information to be disclosed by Renesas Electronics such as that disclosed through our website.
2. Renesas Electronics does not assume any liability for infringement of patents, copyrights, or other intellectual property rights of third parties by or arising from the use of Renesas Electronics products or technical information described in this document. No license, express, implied or otherwise, is granted hereby under any patents, copyrights or other intellectual property rights of Renesas Electronics or others.
3. You should not alter, modify, copy, or otherwise misappropriate any Renesas Electronics product, whether in whole or in part.
4. Descriptions of circuits, software and other related information in this document are provided only to illustrate the operation of semiconductor products and application examples. You are fully responsible for the incorporation of these circuits, software, and information in the design of your equipment. Renesas Electronics assumes no responsibility for any losses incurred by you or third parties arising from the use of these circuits, software, or information.
5. When exporting the products or technology described in this document, you should comply with the applicable export control laws and regulations and follow the procedures required by such laws and regulations. You should not use Renesas Electronics products or the technology described in this document for any purpose relating to military applications or use by the military, including but not limited to the development of weapons of mass destruction. Renesas Electronics products and technology may not be used for or incorporated into any products or systems whose manufacture, use, or sale is prohibited under any applicable domestic or foreign laws or regulations.
6. Renesas Electronics has used reasonable care in preparing the information included in this document, but Renesas Electronics does not warrant that such information is error free. Renesas Electronics assumes no liability whatsoever for any damages incurred by you resulting from errors in or omissions from the information included herein.
7. Renesas Electronics products are classified according to the following three quality grades: “Standard”, “High Quality”, and “Specific”. The recommended applications for each Renesas Electronics product depends on the product’s quality grade, as indicated below. You must check the quality grade of each Renesas Electronics product before using it in a particular application. You may not use any Renesas Electronics product for any application categorized as “Specific” without the prior written consent of Renesas Electronics. Further, you may not use any Renesas Electronics product for any application for which it is not intended without the prior written consent of Renesas Electronics. Renesas Electronics shall not be in any way liable for any damages or losses incurred by you or third parties arising from the use of any Renesas Electronics product for an application categorized as “Specific” or for which the product is not intended where you have failed to obtain the prior written consent of Renesas Electronics. The quality grade of each Renesas Electronics product is “Standard” unless otherwise expressly specified in a Renesas Electronics data sheets or data books, etc.
 - “Standard”: Computers; office equipment; communications equipment; test and measurement equipment; audio and visual equipment; home electronic appliances; machine tools; personal electronic equipment; and industrial robots.
 - “High Quality”: Transportation equipment (automobiles, trains, ships, etc.); traffic control systems; anti-disaster systems; anti-crime systems; safety equipment; and medical equipment not specifically designed for life support.
 - “Specific”: Aircraft; aerospace equipment; submersible repeaters; nuclear reactor control systems; medical equipment or systems for life support (e.g. artificial life support devices or systems), surgical implantations, or healthcare intervention (e.g. excision, etc.), and any other applications or purposes that pose a direct threat to human life.
8. You should use the Renesas Electronics products described in this document within the range specified by Renesas Electronics, especially with respect to the maximum rating, operating supply voltage range, movement power voltage range, heat radiation characteristics, installation and other product characteristics. Renesas Electronics shall have no liability for malfunctions or damages arising out of the use of Renesas Electronics products beyond such specified ranges.
9. Although Renesas Electronics endeavors to improve the quality and reliability of its products, semiconductor products have specific characteristics such as the occurrence of failure at a certain rate and malfunctions under certain use conditions. Further, Renesas Electronics products are not subject to radiation resistance design. Please be sure to implement safety measures to guard them against the possibility of physical injury, and injury or damage caused by fire in the event of the failure of a Renesas Electronics product, such as safety design for hardware and software including but not limited to redundancy, fire control and malfunction prevention, appropriate treatment for aging degradation or any other appropriate measures. Because the evaluation of microcomputer software alone is very difficult, please evaluate the safety of the final products or system manufactured by you.
10. Please contact a Renesas Electronics sales office for details as to environmental matters such as the environmental compatibility of each Renesas Electronics product. Please use Renesas Electronics products in compliance with all applicable laws and regulations that regulate the inclusion or use of controlled substances, including without limitation, the EU RoHS Directive. Renesas Electronics assumes no liability for damages or losses occurring as a result of your noncompliance with applicable laws and regulations.
11. This document may not be reproduced or duplicated, in any form, in whole or in part, without prior written consent of Renesas Electronics.
12. Please contact a Renesas Electronics sales office if you have any questions regarding the information contained in this document or Renesas Electronics products, or if you have any other inquiries.

(Note 1) “Renesas Electronics” as used in this document means Renesas Electronics Corporation and also includes its majority-owned subsidiaries.

(Note 2) “Renesas Electronics product(s)” means any product developed or manufactured by or for Renesas Electronics.

Quick Start

Renesas Starter Kit for M16C/26A

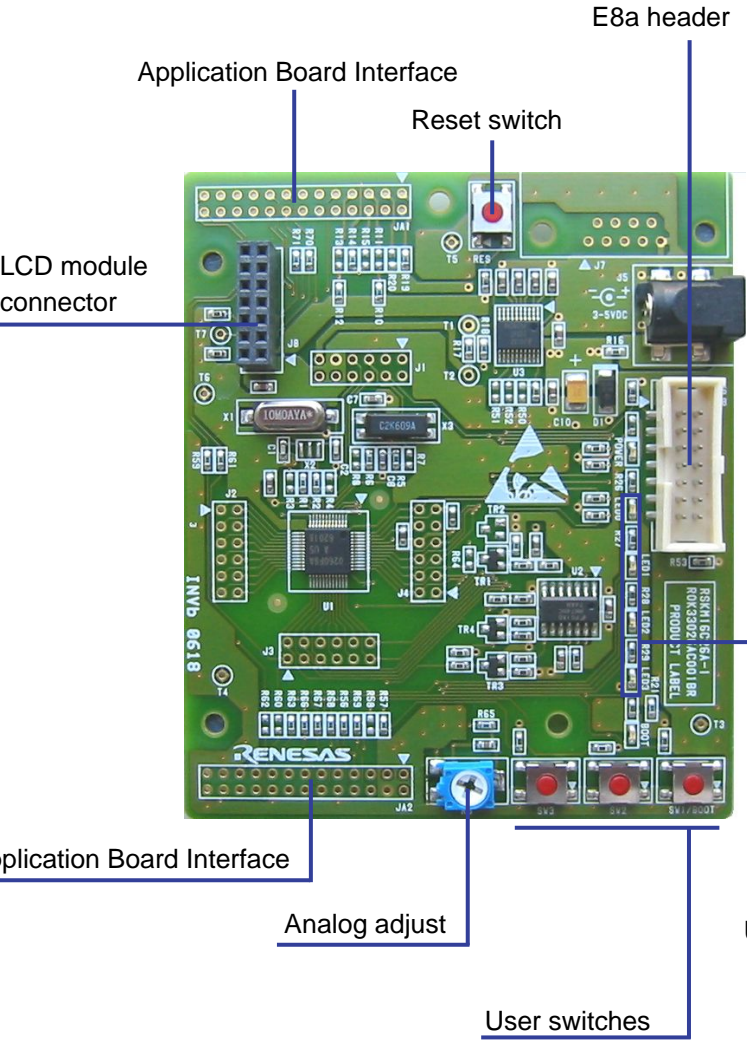
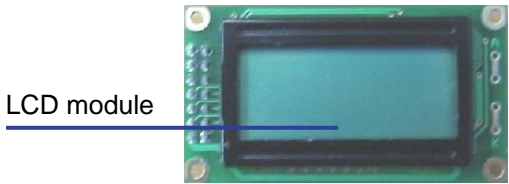

1. Installation

Do not connect the E8a emulator hardware until the software support has been installed.

1. Insert the CD into your computer's CD-ROM drive. The CD should automatically run the installation program. If the installer does not start, browse to the CD root folder and double click on "setup.exe".
2. The installer will ask you which language is to be used, please choose the appropriate one.
3. On the first screen of the installer proper, click <Next>.
4. The License Agreement will be shown, click <Yes>.
5. The next screen asks you to pick the world region – please select and click <Next>.
6. Select the Renesas Starter Kit you wish to install and click <Next>.
7. The destination folders are specified on the next screens. It is recommended to accept the default settings. Click <Next> to continue.
8. Click <Next> on all screens until the installation process commences.
9. After the installation the machine's site code will be shown, this is not important at this stage, click <Next>.
10. Ensure 'Launch AutoUpdate' is selected and click <Finish>.
11. Configure Auto-Update to finish the installation.

2. Connection

12. Now connect the E8a to J6 on the board using the ribbon cable, also connect the LCD module to J8 on the board ensuring that the pin 1 designation corresponds to the marking on the board.

13. Connect the E8a emulator to a spare USB port.

The "Found New Hardware" Wizard will appear. Please follow the steps below to install the drivers. Note that administrator privileges are required for a Windows™ 2000/XP machine.

14. Select 'No, not this time' if dialog appears and click <Next>.
15. Verify the "Recommended" option is selected and click <Next>.
16. If using Windows XP, skip to step 18; otherwise click <Next>.
17. Click <Next> to install the driver.
18. Click <Finish> to close the wizard.

Note: The Windows driver signing dialog may be displayed. Please accept the driver to continue.

3. High-performance Embedded Workshop Workspace

High-performance Embedded Workshop integrates various tools such as compiler, assembler, debugger and editor into a common graphical user interface. To learn more on how to use High-performance Embedded Workshop, open the High-performance Embedded Workshop manual installed on your computer (Start Menu > All Programs > Renesas > High-performance Embedded Workshop > Manual Navigator).

19. Launch High-performance Embedded Workshop from the Start Menu. (Start Menu > All Programs > Renesas > High-performance Embedded Workshop > High-performance Embedded Workshop)
20. In the "Welcome" dialog box: Verify "Create New Workspace" is selected. Click <OK>.
21. In the "New Project Workspace" dialog box: Set the "CPU Family" to "M16C", and verify the "Tool chain" is set to "Renesas M16C Standard". Select "E8A_RSKM16C26A" from the left hand pane.
22. Enter a name for the workspace. The project name will be automatically completed with the Workspace name. You can change this name to "Tutorial" if required. Click <OK>.
23. On the "E8A_RSKM16C26A- Step 1" window: Select "Tutorial" and click <Next>.
24. On the "E8A_RSKM16C26A- Step 2" window: Click <Finish>.
25. On the Project Generator Information window: Click <OK>.

The project that is created has two configurations. The Release configuration can be used for the final release code version. The Debug configuration allows modifications to the configuration for debugging.

26. Select the Debug build configuration in the left hand drop down list on the toolbar.



27. Click on the "Build" icon to compile, assemble and link the project.



4. Programming and Debug

28. Ensure the "SessionM16C_E8a_SYSTEM" session in the right hand drop down list on the toolbar is selected.



29. Click the <Connect> button on the debug toolbar.



30. The "Emulator mode" dialog will be shown. Select the correct MCU group and device type (e.g. M16C/26A Group and M30260F8 for E8A_RSKM16C26A).

Please note that the "Emulator mode" dialog shown here will only appear the FIRST time you connect to the target within a project. On subsequent connections the "Emulator setting" dialog will appear, please choose the same options to connect.

31. Select "Erase Flash and Connect".
 32. If the E8a is to provide power to the CPU board, select "Power Target from Emulator" and choose the "5.0V" option.
 Otherwise connect a 5V centre positive supply.

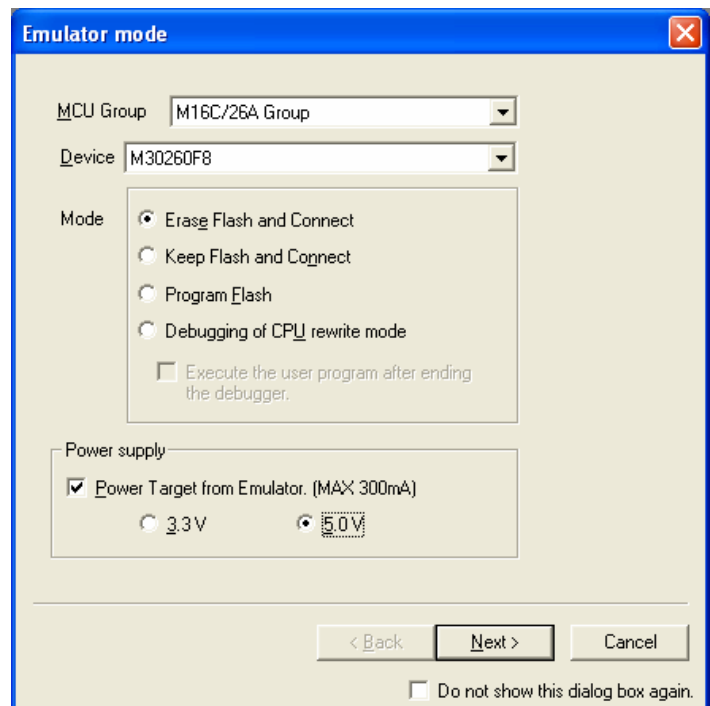

33. Click <Next>.

34. Enter FF000 for the firmware location. It is recommended that the firmware location is towards the top of the memory map.

35. Enter 0B00 for the Work RAM location. It is recommended that the Work RAM is towards the top of the memory map.

36. Ensure that the checkbox "Debugging of program that uses WDT" is not checked.

37. Click <Next>.

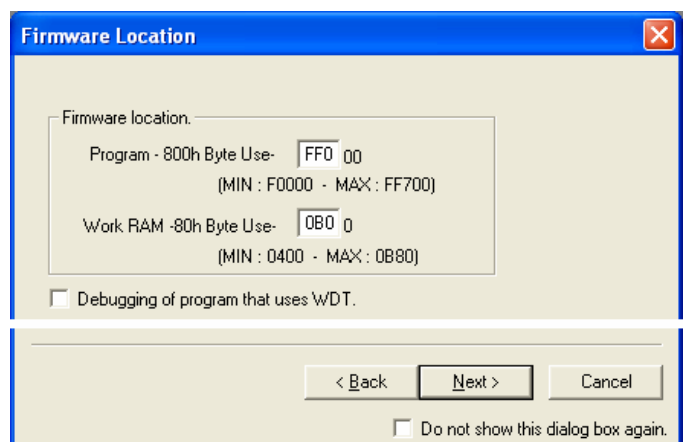

38. The “MCU Setting” dialog will be shown. Leave the default options as shown.
39. Click <Finish>.

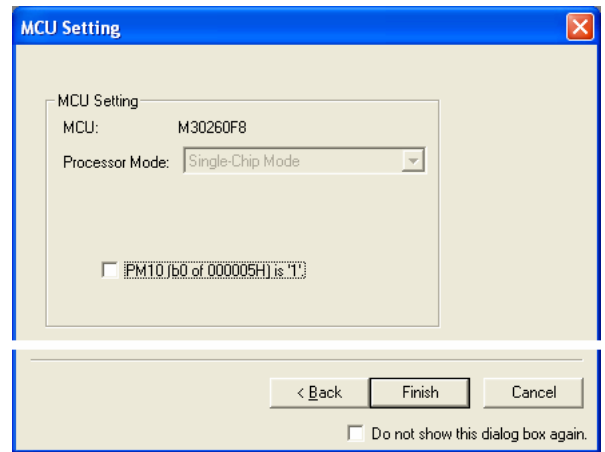



40. Accept any dialog warning that an older version of E8a firmware is necessary to work with the application. Allow download of firmware to complete, this may take several seconds.

The connection to the Renesas Starter Kit will be completed and will activate the debugger buttons on the High-performance Embedded Workshop toolbar.

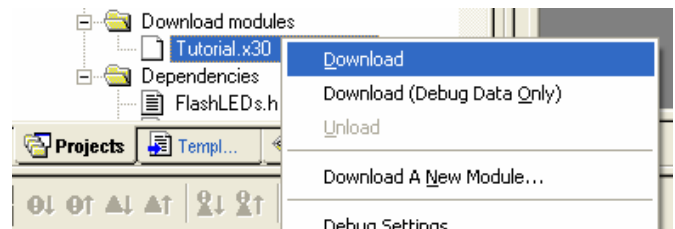
41. Right click on the download module listed in the left hand pane and select “Download”.
The code will be downloaded to the microcontroller.
This may take several seconds.



42. Click the <Reset Go> button. 
The code will run and you will see the LEDs flash on the board.

43. Click the <Stop> button. 
The code will stop and the source code will be opened at the current program counter.

5. Next Step

After you have completed this quick start procedure, please review the tutorial code and sample code that came with the kit. You can add projects to the current workspace by selecting (Project > Insert Project) from the main menu. The tutorials will help you understand the device and development process using Renesas Development Tools. The Hardware manual supplied with this kit is current at the time of publication. Please check for any updates to the device manual from the Renesas website at: www.renesas.com/renesas_starter_kits

6. Renesas M16C Compiler

The version of the compiler provided with this kit is fully functional but time limited. You have 60 days to evaluate the full product before the compiler will limit the code linker to 64k bytes. Full licensed M16C compiler versions are available from your Renesas supplier.

7. Support

Online technical support and information is available at: www.renesas.com/renesas_starter_kits

Technical Contact Details

America: techsupport.rta@renesas.com

Europe: tools.support.eu@renesas.com

Japan: csc@renesas.com

Note on Autoupdate: The Autoupdater is configured to automatically add itself to the Startup folder in the Windows Start Menu and use the registry defaults for access to the web. After restarting the machine the Icon will appear in the System Tray next to the clock. To change the settings or access Autoupdate simply right-click on the icon and use the menu that appears.

© Renesas Solutions Corporation. 2007.

© Renesas Technology Europe Ltd. 2007.

© Renesas Technology Corporation. 2007.

D007064_11_S01_V05