

*RoHS COMPLIANT

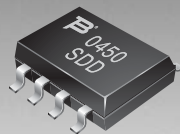

BOURNS®

Features

- RoHS compliant*
- Telcordia GR1089 (Intra-Building)
- Protects 2 lines
- ESD protection >40 kV
- Low capacitance 8 pF

Applications

- T1/E1 line cards
- ISDN U-Interface and S/T Interface
- xDSL
- Ethernet – 10/100 Base T

CDNBS08-PLC03-3.3 Steering Diode/TVS Array Combo

General Information

The markets of portable communications, computing and video equipment are challenging the semiconductor industry to develop increasingly smaller electronic components.

Bourns offers Steering Diode/Transient Voltage Suppressor Array combination diodes for surge and ESD protection applications in an eight lead Narrow Body SOIC package size format.

The Bourns® device will meet IEC 61000-4-2 (ESD), IEC 61000-4-4 (EFT) and IEC 61000-4-5 (Surge) requirements.

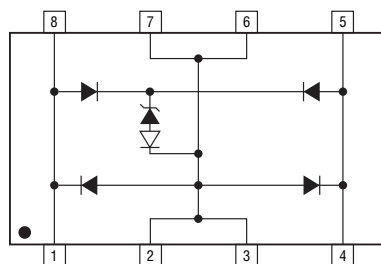

Electrical Characteristics (@ T_A = 25 °C Unless Otherwise Noted)

Parameter	Symbol	Min.	Nom.	Max.	Unit
Capacitance @ 0 V 1 MHz ¹	C _{J(SD)}		20	25	pF
Capacitance @ 0 V 1 MHz ²	C _{J(SD)}		8	12	pF
Working Peak Voltage	V _{WM}			3.0	V
Min. Breakdown Voltage @ 1 mA	V _{BR}	3.3			V
Clamping Voltage @ 8/20 μs @ IPP = 100 A ^{3,4}	V _F			18	V
Clamping Voltage @ 8/20 μs @ IP = 50 A, Line - Ground	V _F			11	V
Max. Leakage Current @ V _{WM}	I _D			2	μA
ESD Protection: IEC 61000-4-2 Contact Discharge Air Discharge		±8 ±15			kV kV
Peak Pulse Power (tp = 8/20 μs) ⁵	P _{PP}			1800	W
EFT Protection: IEC61000-4-4 @ 5/50 ns		40			A
Surge Protection: IEC61000-4-5 @ 8/20 μs L4 (Line-Gnd) L4 (Line-Line) , L1 (Power)		94 48			A A
Surge Protection: Telcordia GR1089 (Intra-Building) @ 2/10 μs		100			A

Notes:

1. Measured between I/O pins and ground (pin 1 or 2).
2. Measured between I/O pins (pins 1 to 4).
3. See Pulse Wave Form. For an 8/20 μs waveform, apply positive pulse to pin 1 to 8 to pin 2 or 3 (ground).
4. Measured between pin 1 or 8 to pin 2 or 3; pin 1 or 8 to pin 4 or 5.
5. See Peak Pulse Power vs. Pulse Time.

Thermal Characteristics (@ T_A = 25 °C Unless Otherwise Noted)

Parameter	Symbol	Min.	Nom.	Max.	Unit
Junction Temperature Range	T _J	-55	+25	+150	°C
Storage Temperature Range	T _{STG}	-55	+25	+150	°C

*RoHS Directive 2002/95/EC Jan 27, 2003 including Annex.
Specifications are subject to change without notice.
Customers should verify actual device performance in their specific applications.

CDNBS08-PLC03-3.3 Steering Diode/TVS Array Combo



Mechanical Characteristics

This is an RoHS compliant molded JEDEC Narrow Body SO-8 package with 100 % Sn plating on the lead frame. It weighs approximately 15 mg and has a flammability rating of UL 94V-0.

Product Dimensions

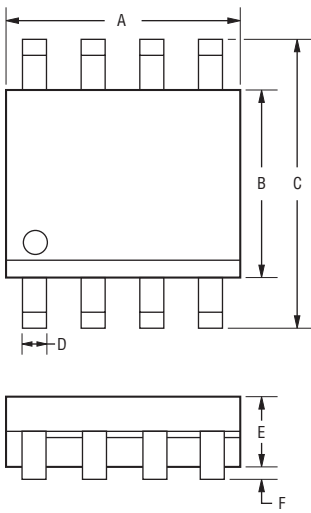

DIMENSIONS = $\frac{\text{MILLIMETERS}}{\text{(INCHES)}}$

Dimensions	
A	$\frac{4.80 - 5.00}{(0.189 - 0.196)}$
B	$\frac{3.80 - 4.00}{(0.150 - 0.157)}$
C	$\frac{5.80 - 6.20}{(0.229 - 0.244)}$
D	$\frac{0.36 - 0.46}{(0.014 - 0.018)}$
E	$\frac{1.35 - 1.75}{(0.054 - 0.068)}$
F	$\frac{0.10 - 0.25}{(0.004 - 0.008)}$
G	$\frac{0.25 - 0.50}{(0.010 - 0.019)}$
H	$\frac{0.40 - 1.250}{(0.016 - 0.049)}$
I	$\frac{0.18 - 0.25}{(0.007 - 0.009)}$

Recommended Footprint

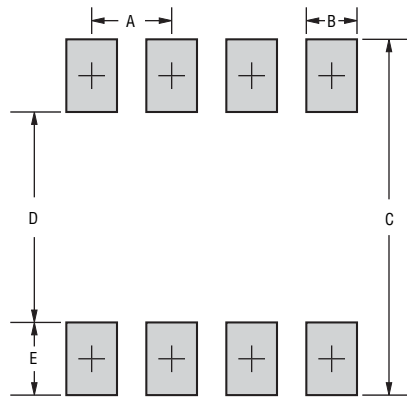

Dimensions	
A	$\frac{1.143 - 1.397}{(0.045 - 0.055)}$
B	$\frac{0.635 - 0.889}{(0.025 - 0.035)}$
C	$\frac{6.223}{(0.245)} \text{ Min.}$
D	$\frac{3.937 - 4.191}{(0.155 - 0.165)}$
E	$\frac{1.016 - 1.27}{(0.040 - 0.050)}$

How To Order

Common Code CD NBS08 - PLC03 - 3.3
 CD = Chip Diode
 Package NBS08 = Narrow Body SOIC8 Package
 Model PLC03 = Model Number
 Minimum Breakdown Voltage 3.3 = 3.3 V_{BR} (Volts)

Typical Part Marking

CDNBS08-PLC03-3.3 PBC

CDNBS08-PLC03-3.3 Steering Diode/TVS Array Combo

BOURNS®

Block Diagram

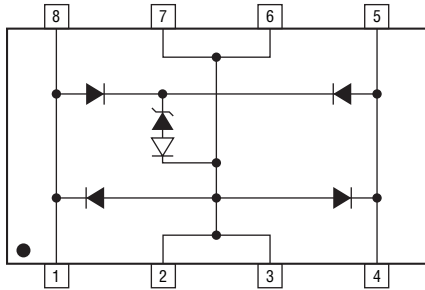

Device Pinout

Pin	Function
1	I/O 1
2	GND
3	GND
4	I/O 2
5	I/O 2
6	GND
7	GND
8	I/O 1

Performance Graphs

Peak Pulse Power vs Pulse Time

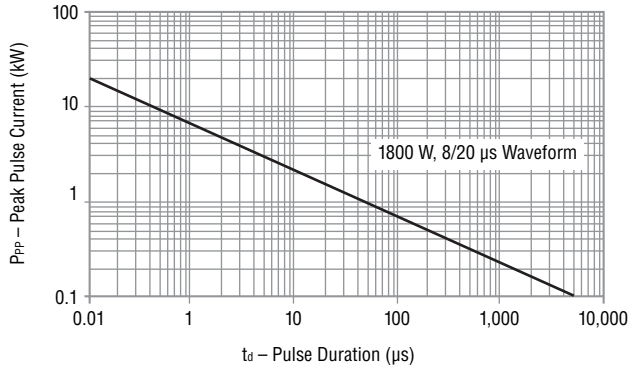

Pulse Wave Form

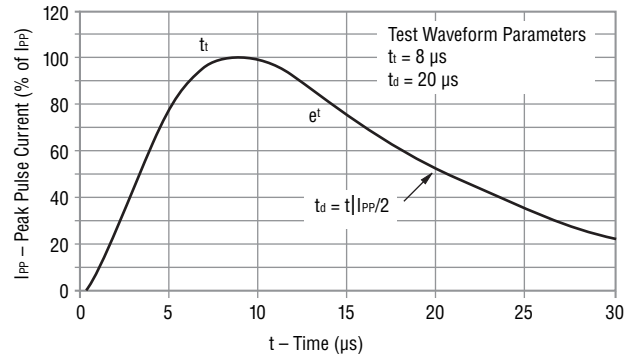

Power Derating Curve

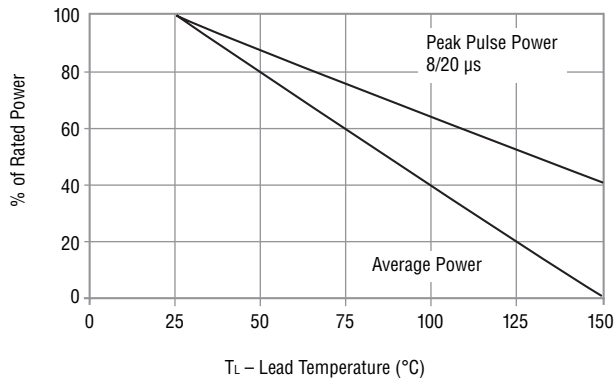

Specifications are subject to change without notice.
 Customers should verify actual device performance in their specific applications.

CDNBS08-PLC03-3.3 Steering Diode/TVS Array Combo

BOURNS®

Packaging Specifications

The product will be dispensed in Tape and Reel format (see diagram below).

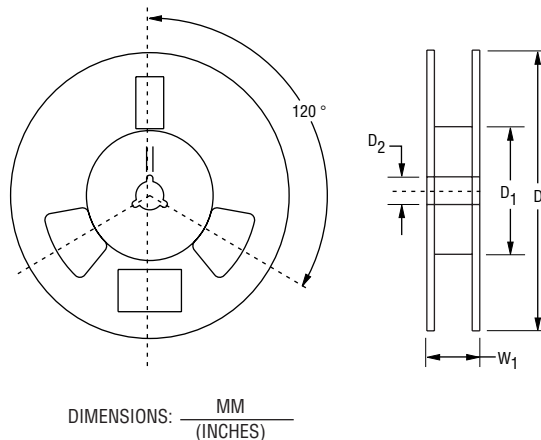
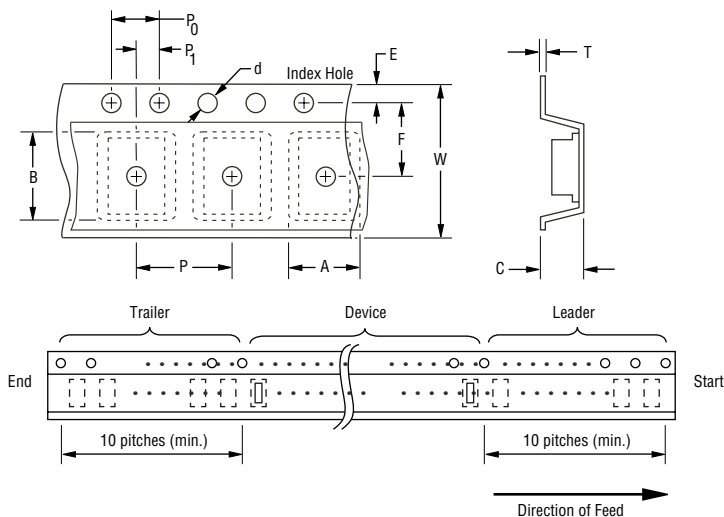

Devices are packed in accordance with EIA standard RS-481-A.

Item	Symbol	NSOIC 8L
Carrier Width	A	$\frac{6.7 \pm 0.10}{(0.264 \pm 0.004)}$
Carrier Length	B	$\frac{5.5 \pm 0.10}{0.217 \pm 0.004}$
Carrier Depth	C	$\frac{2.10 \pm 0.10}{0.083 \pm 0.004}$
Sprocket Hole	d	$\frac{1.55 \pm 0.05}{(0.061 \pm 0.002)}$
Reel Outside Diameter	D	$\frac{330}{(12.992)}$
Reel Inner Diameter	D ₁	$\frac{80.0}{(3.1500)}$ MIN.
Feed Hole Diameter	D ₂	$\frac{13.0 \pm 0.20}{(0.512 \pm 0.008)}$
Sprocket Hole Position	E	$\frac{1.75 \pm 0.10}{(0.069 \pm 0.004)}$
Punch Hole Position	F	$\frac{3.50 \pm 0.05}{(0.138 \pm 0.002)}$
Punch Hole Pitch	P	$\frac{8.00 \pm 0.10}{(0.315 \pm 0.004)}$
Sprocket Hole Pitch	P ₀	$\frac{4.00 \pm 0.10}{(0.157 \pm 0.004)}$
Embossment Center	P ₁	$\frac{2.00 \pm 0.05}{(0.079 \pm 0.002)}$
Overall Tape Thickness	T	$\frac{0.20 \pm 0.10}{(0.008 \pm 0.004)}$
Tape Width	W	$\frac{12.00 \pm 0.20}{(0.472 \pm 0.008)}$
Reel Width	W ₁	$\frac{18.4}{(0.724)}$ MAX.
Quantity per Reel	-	2500

REV. 06/11

Specifications are subject to change without notice.
Customers should verify actual device performance in their specific applications.

BOURNS®

Asia-Pacific:

Tel: +886-2 2562-4117 • Fax: +886-2 2562-4116

Europe:

Tel: +41-41 768 5555 • Fax: +41-41 768 5510

The Americas:

Tel: +1-951 781-5500 • Fax: +1-951 781-5700

www.bourns.com