



GaAs pHEMT MMIC 2 WATT POWER AMPLIFIER, 5.5 - 8.5 GHz

Typical Applications

The HMC7357LP5GE is ideal for:

- Point-to-Point Radios
- Point-to-Multi-Point Radios
- VSAT & SATCOM

Features

- +35 dBm Pout @ 34% PAE
- High P1dB Output Power: +34 dBm
- High Output IP3: +41.5 dBm
- High Gain: 29 dB
- 50 Ohm Matched Input/Output
- Supply Voltage: Vdd = +8V @ 1200 mA
- 24-Lead 5x5 mm SMT Package

Functional Diagram

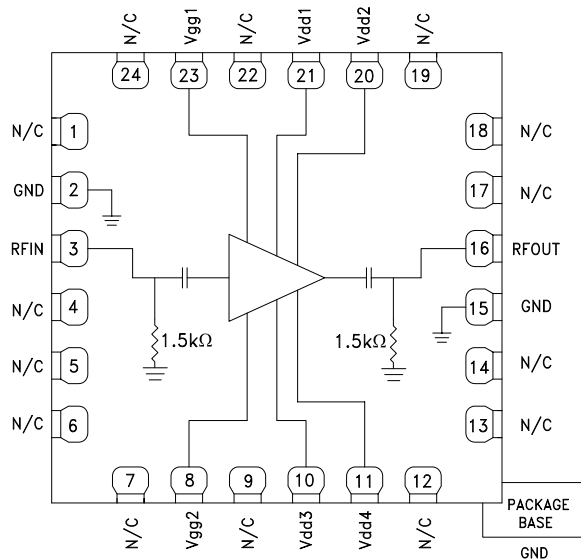

General Description

The HMC7357LP5GE is a three-stage GaAs pHEMT MMIC Medium Power Amplifier that operates between 5.5 and 8.5 GHz. The amplifier provides 29 dB of gain and +35 dBm of saturated output power at 34% PAE from a +8V supply. With an excellent Output IP3 of +41.5 dBm, the HMC7357LP5GE is ideal for linear applications such as high capacity point-to-point and point-to-multi-point radios or VSAT/SATCOM applications demanding +35 dBm of efficient saturated output power. The RF I/Os are internally matched to 50 Ohms for ease of use. The HMC7357LP5GE is packaged in a leadless 5x5 mm plastic surface mount package and is compatible with surface mount manufacturing techniques.

Electrical Specifications, $T_A = +25^\circ C$

$V_{dd1} = V_{dd2} = V_{dd3} = V_{dd4} = 8V$, $I_{dd} = 1200 mA$ [1]

Parameter	Min.	Typ.	Max.	Min.	Typ.	Max.	Units
Frequency Range	5.5 - 7		7 - 8.5				GHz
Gain	26.5	29.5		28	31		dB
Gain Variation Over Temperature		0.0214			0.0234		dB/ °C
Input Return Loss		14			14		dB
Output Return Loss		22			15		dB
Output Power for 1 dB Compression (P1dB)	31.5	34.5		31.5	34.5		dBm
Saturated Output Power (P _{sat})		35			35		dBm
Output Third Order Intercept (IP3) ^[2]		41.5			41.5		dBm
Total Supply Current (I _{dd})		1200			1200		mA

[1] Adjust V_{gg} between -2 to -0.4V to achieve I_{dd} = 1200 mA typical.

[2] Measurement taken at +8V @ 1200 mA, P_{out} / Tone = +20 dBm

HMC7357* PRODUCT PAGE QUICK LINKS

Last Content Update: 02/23/2017

COMPARABLE PARTS

View a parametric search of comparable parts.

EVALUATION KITS

- HMC7357LP5G Evaluation Board

DOCUMENTATION

Application Notes

- AN-1363: Meeting Biasing Requirements of Externally Biased RF/Microwave Amplifiers with Active Bias Controllers
- Broadband Biasing of Amplifiers General Application Note
- MMIC Amplifier Biasing Procedure Application Note
- Thermal Management for Surface Mount Components General Application Note

Data Sheet

- HMC7357 Data Sheet

REFERENCE MATERIALS

Quality Documentation

- Package/Assembly Qualification Test Report: LP3, LP4, LP5 & LP5G (QTR: 2014-00145)

DESIGN RESOURCES

- HMC7357 Material Declaration
- PCN-PDN Information
- Quality And Reliability
- Symbols and Footprints

DISCUSSIONS

View all HMC7357 EngineerZone Discussions.

SAMPLE AND BUY

Visit the product page to see pricing options.

TECHNICAL SUPPORT

Submit a technical question or find your regional support number.

DOCUMENT FEEDBACK

Submit feedback for this data sheet.



GaAs pHEMT MMIC 2 WATT POWER AMPLIFIER, 5.5 - 8.5 GHz

Gain & Return Loss

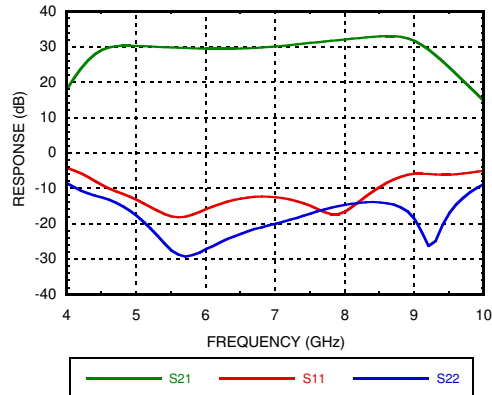

Gain vs. Temperature

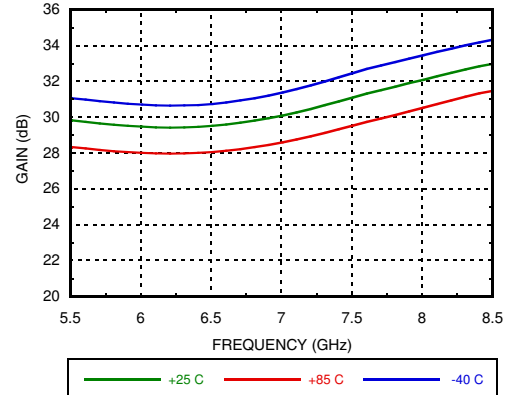

Input Return Loss vs. Temperature

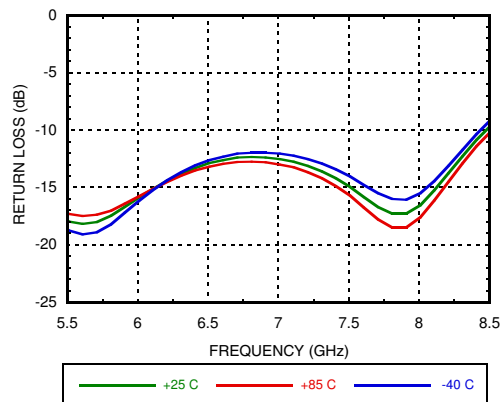

Output Return Loss vs. Temperature

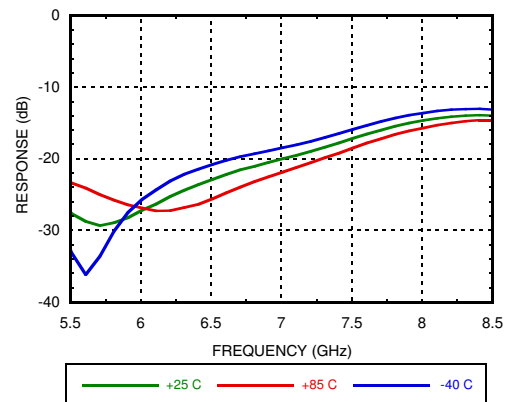

P1dB vs. Temperature

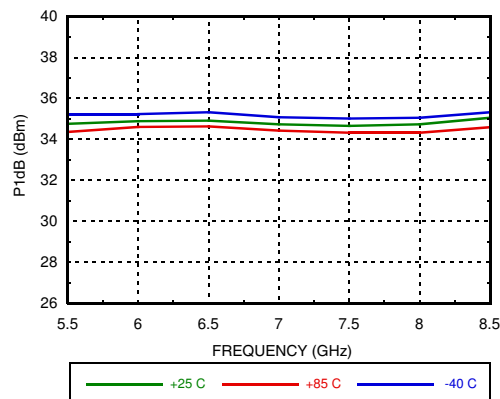

P1dB vs. Supply Voltage

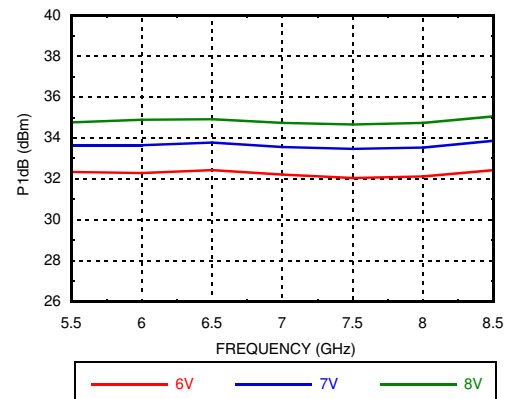

Information furnished by Analog Devices is believed to be accurate and reliable. However, no responsibility is assumed by Analog Devices for its use, nor for any infringements of patents or other rights of third parties that may result from its use. Specifications subject to change without notice. No license is granted by implication or otherwise under any patent or patent rights of Analog Devices. Trademarks and registered trademarks are the property of their respective owners.

For price, delivery, and to place orders: Analog Devices, Inc., One Technology Way, P.O. Box 9106, Norwood, MA 02062-9106 Phone: 781-329-4700 • Order online at www.analog.com Application Support: Phone: 1-800-ANALOG-D



**GaAs pHEMT MMIC 2 WATT
POWER AMPLIFIER, 5.5 - 8.5 GHz**

Psat vs. Temperature

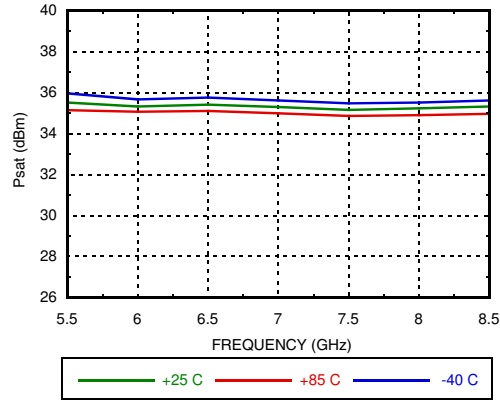

Psat vs. Supply Voltage

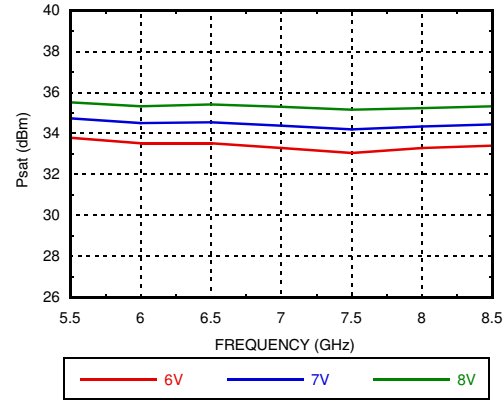

P1dB vs. Supply Current

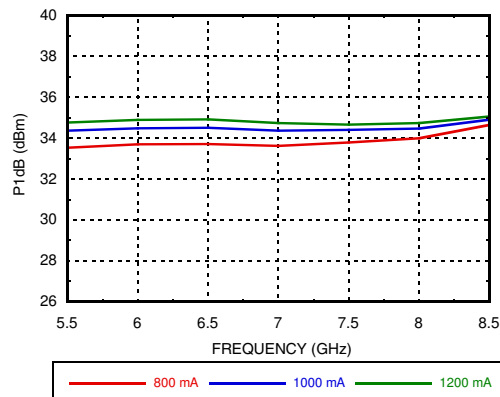

Psat vs. Supply Current

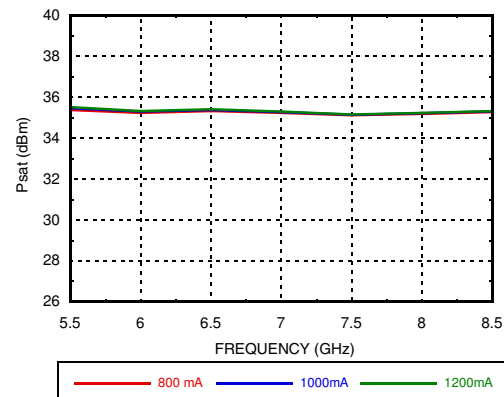

**Output IP3 vs. Temperature,
Pout/1tone = +20 dBm**

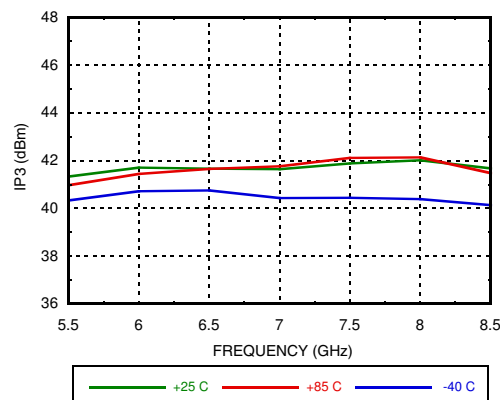

**Output IP3 vs. Supply Current,
Pout/1tone = +20 dBm**

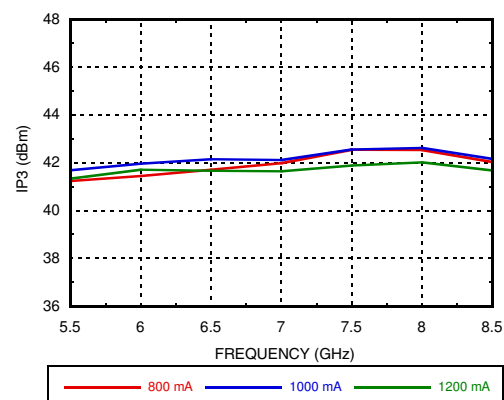

Information furnished by Analog Devices is believed to be accurate and reliable. However, no responsibility is assumed by Analog Devices for its use, nor for any infringements of patents or other rights of third parties that may result from its use. Specifications subject to change without notice. No license is granted by implication or otherwise under any patent or patent rights of Analog Devices. Trademarks and registered trademarks are the property of their respective owners.

For price, delivery, and to place orders: Analog Devices, Inc., One Technology Way, P.O. Box 9106, Norwood, MA 02062-9106 Phone: 781-329-4700 • Order online at www.analog.com Application Support: Phone: 1-800-ANALOG-D



GaAs pHEMT MMIC 2 WATT POWER AMPLIFIER, 5.5 - 8.5 GHz

Output IP3 vs. Supply Voltage, Pout/tone = +20 dBm

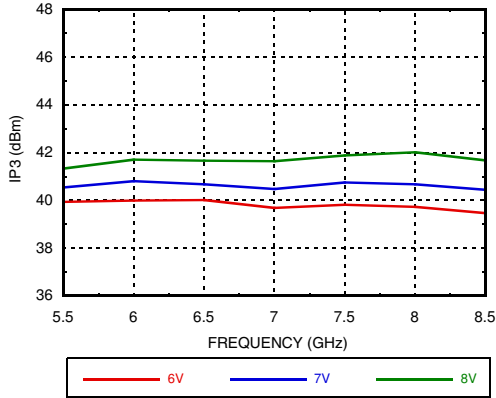

Output IM3 @ Vdd = +6V

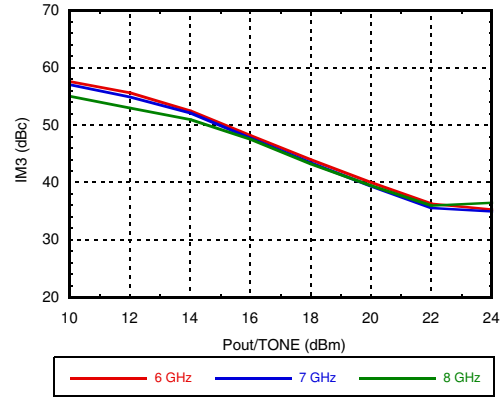

Output IM3 @ Vdd = +7V

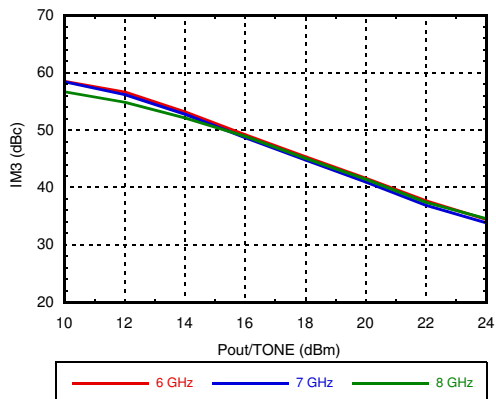

Output IM3 @ Vdd = +8V

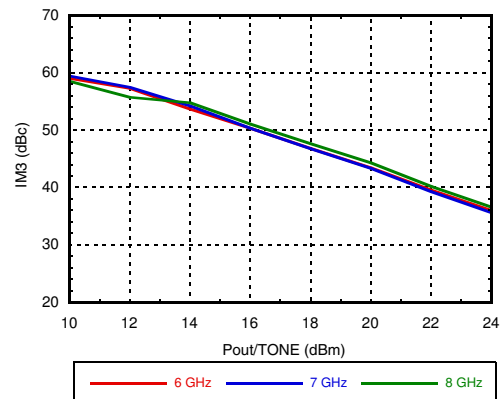

Power Compression @ 6 GHz

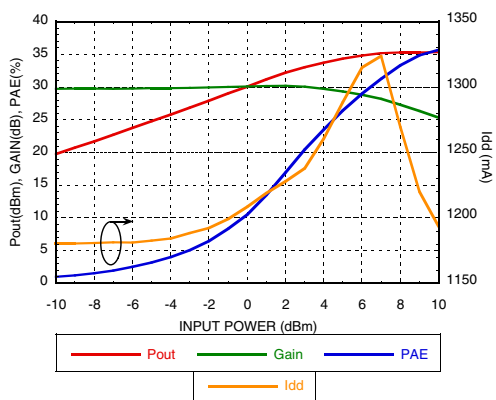

Power Compression @ 7 GHz

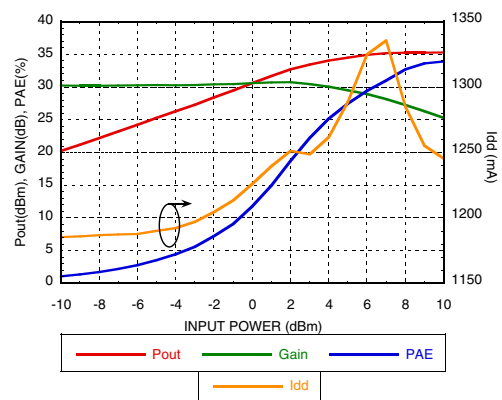

Information furnished by Analog Devices is believed to be accurate and reliable. However, no responsibility is assumed by Analog Devices for its use, nor for any infringements of patents or other rights of third parties that may result from its use. Specifications subject to change without notice. No license is granted by implication or otherwise under any patent or patent rights of Analog Devices. Trademarks and registered trademarks are the property of their respective owners.

For price, delivery, and to place orders: Analog Devices, Inc., One Technology Way, P.O. Box 9106, Norwood, MA 02062-9106 Phone: 781-329-4700 • Order online at www.analog.com Application Support: Phone: 1-800-ANALOG-D



GaAs pHEMT MMIC 2 WATT POWER AMPLIFIER, 5.5 - 8.5 GHz

Power Compression @ 8 GHz

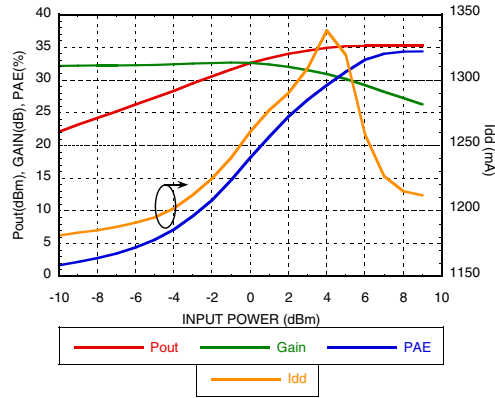

Reverse Isolation vs. Temperature

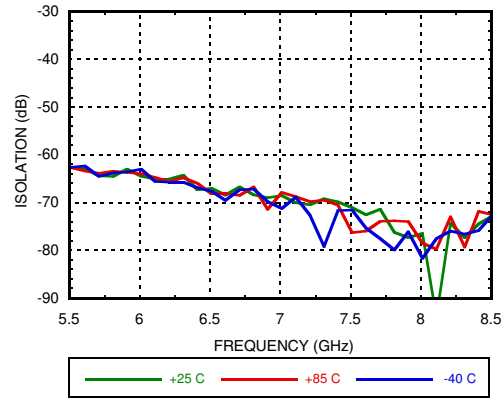

Gain & Power vs. Supply Current @ 7 GHz

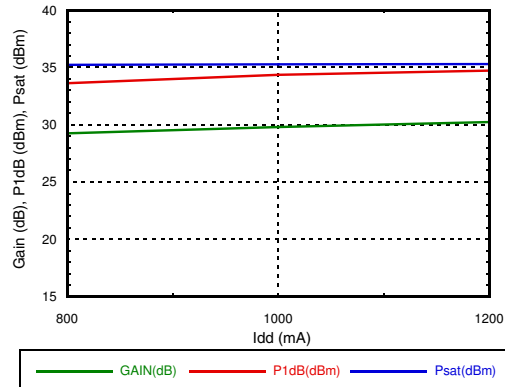

Gain & Power vs. Supply Voltage @ 7 GHz

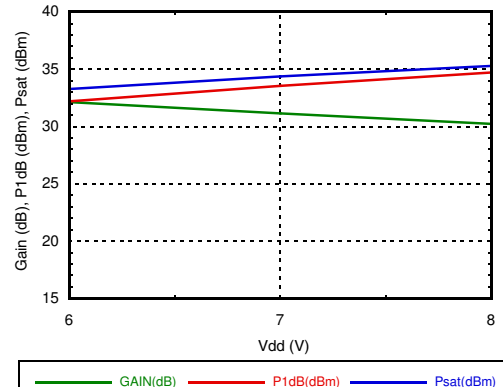

Power Dissipation

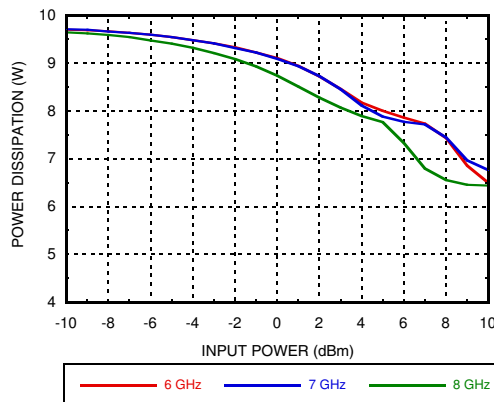

Information furnished by Analog Devices is believed to be accurate and reliable. However, no responsibility is assumed by Analog Devices for its use, nor for any infringements of patents or other rights of third parties that may result from its use. Specifications subject to change without notice. No license is granted by implication or otherwise under any patent or patent rights of Analog Devices. Trademarks and registered trademarks are the property of their respective owners.

For price, delivery, and to place orders: Analog Devices, Inc., One Technology Way, P.O. Box 9106, Norwood, MA 02062-9106 Phone: 781-329-4700 • Order online at www.analog.com Application Support: Phone: 1-800-ANALOG-D



GaAs pHEMT MMIC 2 WATT POWER AMPLIFIER, 5.5 - 8.5 GHz

Absolute Maximum Ratings

Drain Bias Voltage (Vdd)	+9 Vdc
Gate Bias Voltage (Vgg)	-2 to -0.4 Vdc
RF Input Power (RFIN)	+22 dBm
Channel Temperature	175 °C
Continuous P _{diss} (T= 85 °C) (derate 133mW/°C above 85 °C)	12.6 W
Thermal Resistance (channel to ground paddle)	7.5 °C/W
Storage Temperature	-65 to 150°C
Operating Temperature	-40 to 85 °C
ESD Sensitivity (HBM)	Class 1A, passed 250V

Typical Supply Current vs. Vdd

Vdd (V)	I _{dd} (mA)
+6	1200
+7	1200
+8	1200

Adjust Vgg to achieve I_{dd} = 1200 mA



**ELECTROSTATIC SENSITIVE DEVICE
OBSERVE HANDLING PRECAUTIONS**

Outline Drawing

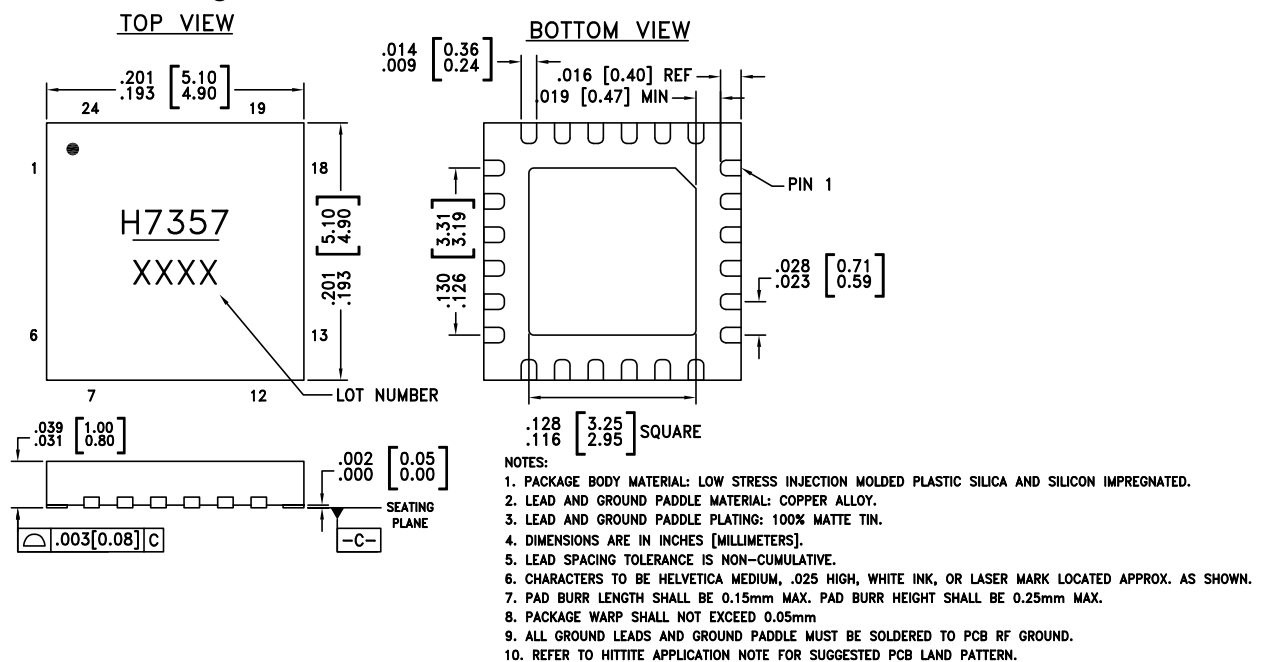

Package Information

Part Number	Package Body Material	Lead Finish	MSL Rating [2]	Package Marking [1]
HMC7357LP5GE	RoHS-compliant Low Stress Injection Molded Plastic	100% matte Sn	MSL1	H7357 XXXX

[1] 4-Digit lot number XXXX

[2] Max peak reflow temperature of 260 °C



GaAs pHEMT MMIC 2 WATT POWER AMPLIFIER, 5.5 - 8.5 GHz

Pin Descriptions

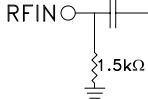
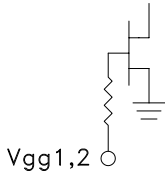
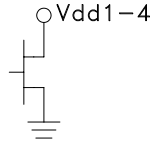
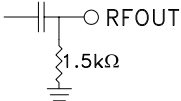
Pad Number	Function	Description	Interface Schematic
1, 4, 5, 6, 7, 9, 12, 13, 14, 17, 18, 19, 22, 24	N/C	These pins are not connected internally; however all data shown herein was measured with these pins connected to RF/DC ground externally.	
2, 15	GND	These pins and exposed ground paddle must be connected to RF/DC ground.	
3	RFIN	This pin is DC coupled and matched to 50 Ohms.	
8, 23	Vgg2, Vgg1	Gate control for PA. Adjust Vgg to achieve recommended bias current. External bypass capacitors of 100 pF, 10 nF, and 4.7 μF are required. Apply Vgg bias to either pin 8 or pin 23.	
10, 11, 20, 21	Vdd3, Vdd4, Vdd2, Vdd1	Drain bias voltage for the amplifier. External bypass capacitors of 100 pF, 10 nF, and 4.7 μF are required.	
16	RFOUT	This pin is DC coupled and matched to 50 Ohms.	



**GaAs pHEMT MMIC 2 WATT
POWER AMPLIFIER, 5.5 - 8.5 GHz**

Application Circuit

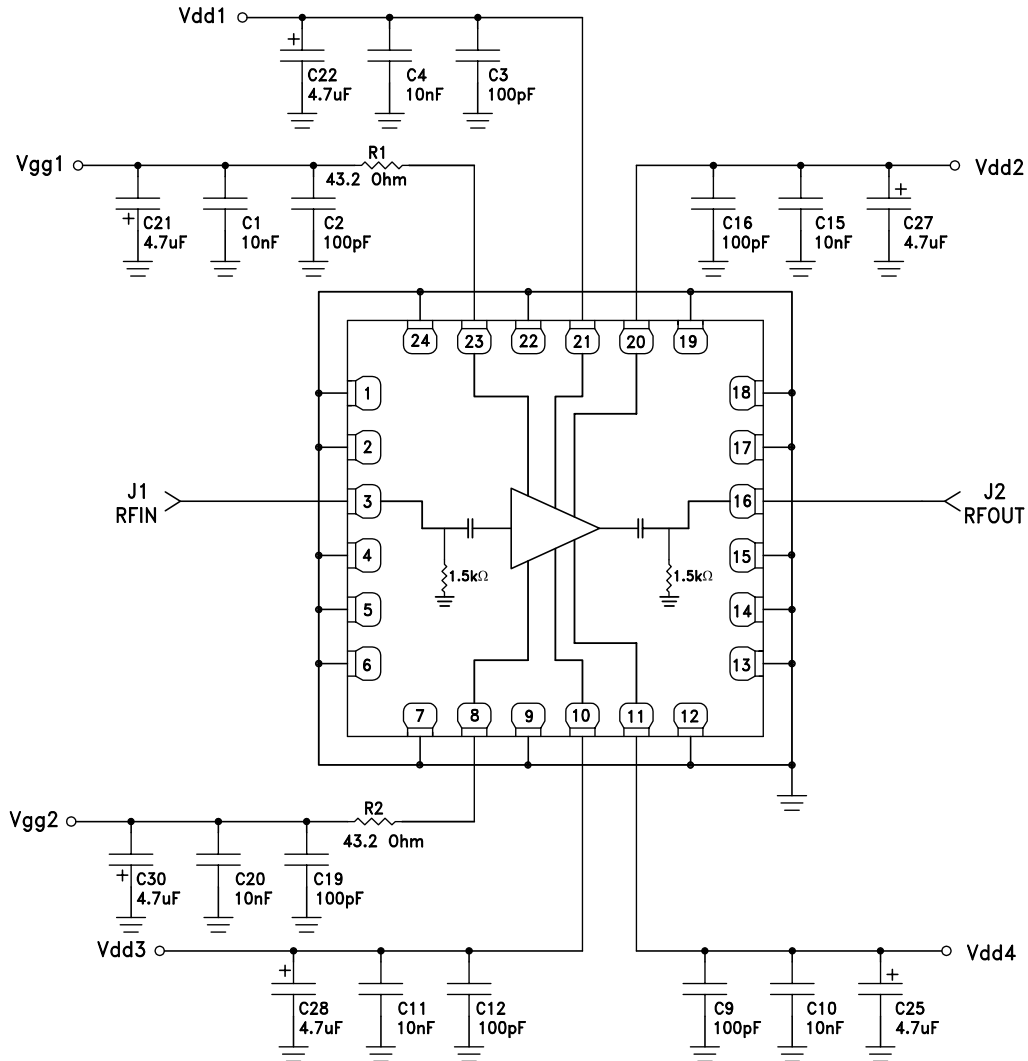

Information furnished by Analog Devices is believed to be accurate and reliable. However, no responsibility is assumed by Analog Devices for its use, nor for any infringements of patents or other rights of third parties that may result from its use. Specifications subject to change without notice. No license is granted by implication or otherwise under any patent or patent rights of Analog Devices. Trademarks and registered trademarks are the property of their respective owners.

For price, delivery, and to place orders: Analog Devices, Inc., One Technology Way, P.O. Box 9106, Norwood, MA 02062-9106 Phone: 781-329-4700 • Order online at www.analog.com Application Support: Phone: 1-800-ANALOG-D



GaAs pHEMT MMIC 2 WATT POWER AMPLIFIER, 5.5 - 8.5 GHz

Evaluation PCB

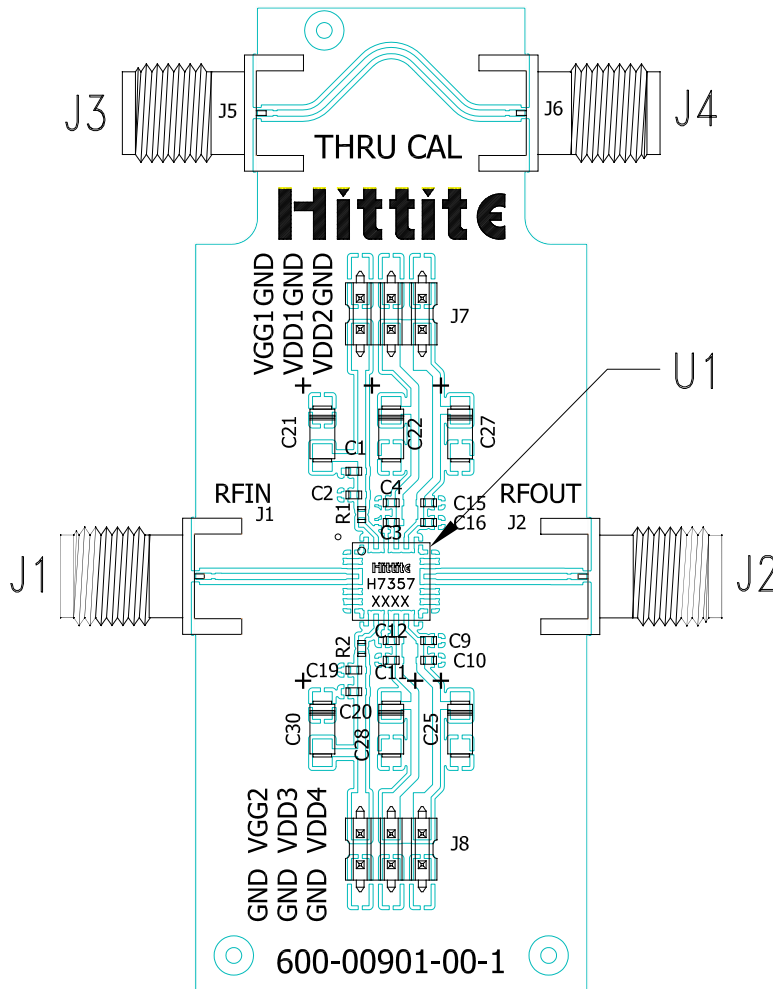

List of Materials for Evaluation PCB EV1HMC7357LP5 [1]

Item	Description
J1 - J4	"K" Connector, SRI
J7, J8	DC Pin
C2, C3, C9, C12, C16, C19	100 pF Capacitor, 0402 Pkg.
C1, C4, C10, C11, C15, C20	10000 pF Capacitor, 0402 Pkg.
C21, C22, C25, C27, C28, C30	4.7 uF Capacitor, Case A Pkg.
R1, R2	43.2 Ohm Resistor, 0402 Pkg
U1	HMC7357LP5GE Amplifier
PCB [2]	600-00901-00 Eval Board

[1] Reference this number when ordering complete evaluation PCB

[2] Circuit Board Material: Rogers 4350

The circuit board used in the application should use RF circuit design techniques. Signal lines should have 50 Ohm impedance while the package ground leads and exposed paddle should be connected directly to the ground plane similar to that shown. A sufficient number of via holes should be used to connect the top and bottom ground planes. The evaluation circuit board shown is available from Hittite upon request.

**GaAs pHEMT MMIC 2 WATT
POWER AMPLIFIER, 5.5 - 8.5 GHz****Notes:**