



# MOP-AV202C

---

## Parallel Display Specifications

Revision 1.0

# Revision History

| Revision | Description     | Author |
|----------|-----------------|--------|
| 1.0      | Initial Release | Clark  |

## Contents

|                              |    |
|------------------------------|----|
| Revision History .....       | 1  |
| Contents .....               | 2  |
| Features .....               | 3  |
| Hardware .....               | 3  |
| Drawing .....                | 3  |
| Interface .....              | 3  |
| Instructions .....           | 4  |
| Outline .....                | 4  |
| Instruction Table .....      | 5  |
| Character ROM .....          | 6  |
| Character RAM .....          | 7  |
| Timing Characteristics ..... | 7  |
| Initialization .....         | 8  |
| Specifications .....         | 9  |
| Electrical .....             | 9  |
| Optical .....                | 9  |
| Environmental .....          | 9  |
| Troubleshooting .....        | 9  |
| Power .....                  | 9  |
| Display .....                | 10 |
| Communication .....          | 10 |
| Test Mode .....              | 12 |
| Precautions .....            | 12 |
| Ordering .....               | 13 |
| Part Numbering Scheme .....  | 13 |
| Options .....                | 13 |
| Contact .....                | 13 |

## Features

The Matrix Orbital Parallel display series offers a low cost display solution utilizing an industry standard communication interface for simple integration into a wide variety of new and existing applications. The luminous text with configurable brightness and a variety of filter options allow the MOP Vacuum Florescent Display line to offer a robust yet stylish display solution for any project. The standard alphanumeric font set also allows up to eight custom characters to be saved in display Random Access Memory for a custom design touch.

## Hardware

### Drawing

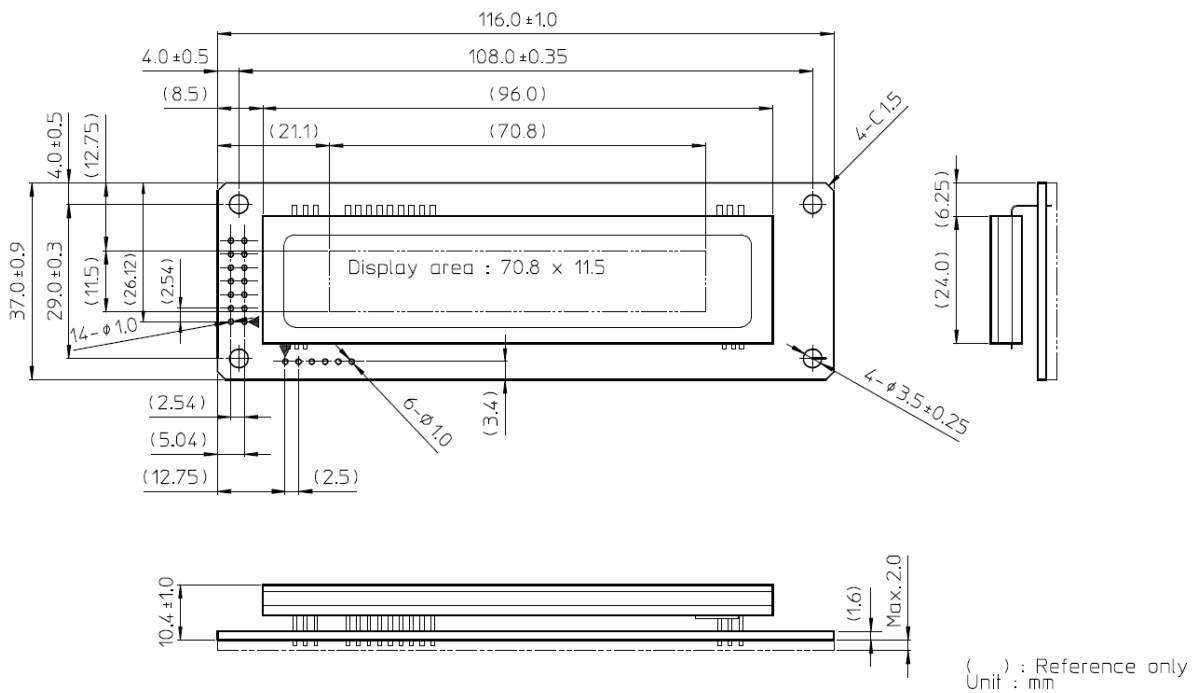

Figure 1: MOP-AV204A Mechanical Drawing

## Interface

Table 1: Display Control

| Pin | Symbol          | Description     |
|-----|-----------------|-----------------|
| 1   | V <sub>SS</sub> | Ground          |
| 2   | V <sub>CC</sub> | Supply Voltage  |
| 3   | NC              | No Connect      |
| 4   | RS              | Register Select |
| 5   | R/W             | Read/Write      |
| 6   | E               | Enable          |

Table 2: Parallel Data

| Pin | Symbol | Description |
|-----|--------|-------------|
| 7   | DB0    | *Data bit 0 |
| 8   | DB1    | *Data bit 1 |
| 9   | DB2    | *Data bit 2 |
| 10  | DB3    | *Data bit 3 |
| 11  | DB4    | Data bit 4  |
| 12  | DB5    | Data bit 5  |
| 13  | DB6    | Data bit 6  |
| 14  | DB7    | Data bit 7  |

\*Note: Not used in 4-bit mode

# Instructions

## Outline

The MOP line is controlled using a standard HD44780 compliant controller. The display is enabled by pulling the Chip Enable (E) pin high, communication to and from the device is controlled using the Read/Write (R/W) input, and one of two available 8-bit registers are selected via the Register Select (RS) line. Using Register Select, either the Instruction Register (IR) or Data Register (DR) is selected by toggling RS low or high respectively.

While executing from the IR, the display will pull the Most Significant Bit of the data bus, DB7, high. While this Busy Flag (BF) is set, any instructions sent to the unit will be ignored. The status of this flag and the current position of the Address Counter (AC) can be obtained by performing a read operation on the instruction register at any time.

Table 3: Register Selection

| RS | R/W | Operation   |
|----|-----|---|
| 0  | 0   | IR write as an internal operation (display clear, etc.) |
| 0  | 1   | Read busy flag (DB7) and address counter (DB0 to DB6)   |
| 1  | 0   | Write data to DDRAM or CGRAM (DR to DDRAM or CGRAM)     |
| 1  | 1   | Read data from DDRAM or CGRAM (DDRAM or CGRAM to DR)    |

When writing for the DR, one of two locations can be chosen using the AC. The value provided to the AC when executing a set address command differentiates these locations. The AC is automatically decremented or incremented after a read or a write.

DDRAM provides eighty bytes of display memory to all displays. Memory outside the bounds of the display area can be used as general RAM. DDRAM addressing begins at the top left of the display with a value of 0, addresses then increment from left to right then down once a row is filled.

Table 4: Two Line Addressing

| Position | 1  | 2  | ... | 40 |
|----------|----|----|-----|----|
| DDRAM    | 00 | 01 | ... | 27 |
| Address  | 40 | 41 | ... | 67 |

Table 5: Four Line Addressing

| Position | 1  | 2  | ... | 20 |
|----------|----|----|-----|----|
| DDRAM    | 00 | 01 | ... | 13 |
| Address  | 40 | 41 | ... | 53 |
| DDRAM    | 14 | 15 | ... | 27 |
| Address  | 54 | 55 | ... | 67 |

CGRAM provides eight custom characters that can be created by writing to CGRAM locations then displayed using the first eight CGROM character codes, as seen in the character ROM table below.

Characters are sent to the display by performing a write operation on the DR using the correct character address within CGROM. Instructions are issued by writing to the IR; a complete list is available below.

## Instruction Table

Table 6: Parallel Instruction Table

| Instruction                | Instruction Code |                |     |     |     |     |     |     |     |     | Description  |   |     |     |            |   |   |                |   |   |     |   |   |     |   |   |     |
|----------------------------|------------------|----------------|-----|-----|-----|-----|-----|-----|-----|-----|--|---|-----|-----|------------|---|---|----------------|---|---|-----|---|---|-----|---|---|-----|
|                            | RS               | R/W            | DB7 | DB6 | DB5 | DB4 | DB3 | DB2 | DB1 | DB0 |  |   |     |     |            |   |   |                |   |   |     |   |   |     |   |   |     |
| Clear Display              | 0                | 0              | 0   | 0   | 0   | 0   | 0   | 0   | 0   | 1   | Write "20H" to all DDRAM locations, set DDRAM address to "00H", return cursor to its original position, and set I/D to "1".                    |   |     |     |            |   |   |                |   |   |     |   |   |     |   |   |     |
| Return Home                | 0                | 0              | 0   | 0   | 0   | 0   | 0   | 0   | 0   | 1   | —  | Set DDRAM address to "00H" and return cursor to its original position if shifted. The contents of DDRAM are not changed.  |     |     |            |   |   |                |   |   |     |   |   |     |   |   |     |
| Entry Mode Set             | 0                | 0              | 0   | 0   | 0   | 0   | 0   | 0   | 1   | I/D | SH   | Assign cursor moving direction and enable the shift of entire display. DDRAM and CRAM addresses are incremented and cursor moves right when I/D is set to "1", the opposite is true when reset to "0". Setting SH to "1" causes the entire display to shift affecting only DDRAM.   |     |     |            |   |   |                |   |   |     |   |   |     |   |   |     |
| Display ON/OFF Control     | 0                | 0              | 0   | 0   | 0   | 0   | 0   | 1   | D   | —   | B  | Set display (D), and blinking of cursor (B) on/off control bit. Setting D or B to "1" will cause the display or blinking cursor to turn on; the opposite is true for reset.   |     |     |            |   |   |                |   |   |     |   |   |     |   |   |     |
| Cursor or Display Shift    | 0                | 0              | 0   | 0   | 0   | 0   | 1   | S/C | R/L | —   | —  | Set cursor moving and display shift control bit, and the direction, without changing of DDRAM data. Setting S/L to "1" will shift the screen horizontally while the opposite will move the cursor through all screen positions. Setting R/L to "1" will shift right immediately. AC and DDRAM are not altered.            |     |     |            |   |   |                |   |   |     |   |   |     |   |   |     |
| Function Set               | 0                | 0              | 0   | 0   | 0   | 1   | DL  | —   | —   | —   | —  | Set interface data length. Setting DL to "1" specifies 8-bit mode, "0" 4-bit.   |     |     |            |   |   |                |   |   |     |   |   |     |   |   |     |
| Set Brightness             | 1                | 0              | —   | —   | —   | —   | —   | —   | —   | BR1 | BR0  | <table border="1"> <thead> <tr> <th>BR1</th> <th>BR0</th> <th>Brightness</th> </tr> </thead> <tbody> <tr> <td>0</td> <td>0</td> <td>100% (Default)</td> </tr> <tr> <td>0</td> <td>1</td> <td>75%</td> </tr> <tr> <td>1</td> <td>0</td> <td>50%</td> </tr> <tr> <td>1</td> <td>1</td> <td>25%</td> </tr> </tbody> </table> | BR1 | BR0 | Brightness | 0 | 0 | 100% (Default) | 0 | 1 | 75% | 1 | 0 | 50% | 1 | 1 | 25% |
| BR1                        | BR0              | Brightness     |     |     |     |     |     |     |     |     |  |   |     |     |            |   |   |                |   |   |     |   |   |     |   |   |     |
| 0                          | 0                | 100% (Default) |     |     |     |     |     |     |     |     |  |   |     |     |            |   |   |                |   |   |     |   |   |     |   |   |     |
| 0                          | 1                | 75%            |     |     |     |     |     |     |     |     |  |   |     |     |            |   |   |                |   |   |     |   |   |     |   |   |     |
| 1                          | 0                | 50%            |     |     |     |     |     |     |     |     |  |   |     |     |            |   |   |                |   |   |     |   |   |     |   |   |     |
| 1                          | 1                | 25%            |     |     |     |     |     |     |     |     |  |   |     |     |            |   |   |                |   |   |     |   |   |     |   |   |     |
| Set CGRAM Address          | 0                | 0              | 0   | 1   | AC5 | AC4 | AC3 | AC2 | AC1 | AC0 | Set CGRAM address in address counter.  |   |     |     |            |   |   |                |   |   |     |   |   |     |   |   |     |
| Set DDRAM Address          | 0                | 0              | 1   | AC6 | AC5 | AC4 | AC3 | AC2 | AC1 | AC0 | Set DDRAM address in address counter.  |   |     |     |            |   |   |                |   |   |     |   |   |     |   |   |     |
| Read Busy Flag and Address | 0                | 1              | BF  | AC6 | AC5 | AC4 | AC3 | AC2 | AC1 | AC0 | Read the status of the display controller through the BF Bit. The contents of address counter can also be read.                                |   |     |     |            |   |   |                |   |   |     |   |   |     |   |   |     |
| Write Data to RAM          | 1                | 0              | D7  | D6  | D5  | D4  | D3  | D2  | D1  | D0  | Write data into internal RAM (DDRAM/CGRAM), location is determined by the AC. AC and display shift are adjusted as specified.                  |   |     |     |            |   |   |                |   |   |     |   |   |     |   |   |     |
| Read Data from RAM         | 1                | 1              | D7  | D6  | D5  | D4  | D3  | D2  | D1  | D0  | Read data from internal RAM (DDRAM/CGRAM), location is determined by the AC, set command is recommended previous to this. Only AC is adjusted. |   |     |     |            |   |   |                |   |   |     |   |   |     |   |   |     |

## Character ROM

The character generator ROM stores up to two hundred fifty-six 5×7 dot character patterns from 8-bit character codes. The first sixteen characters are reserved for custom characters saved in CGRAM.

|      |      | D7 | D6 | D5 | D4 |    |   |   |   |   |   |   |   |   |   |   |   |  |  |  |  |
|------|------|----|----|----|----|----|---|---|---|---|---|---|---|---|---|---|---|--|--|--|--|
|      |      | 0  | 0  | 0  | 0  | 0  | 0 | 0 | 0 | 1 | 1 | 1 | 1 | 1 | 1 | 1 | 1 |  |  |  |  |
|      |      | 0  | 0  | 0  | 0  | 1  | 1 | 1 | 1 | 0 | 0 | 0 | 1 | 1 | 1 | 1 | 1 |  |  |  |  |
|      |      | 0  | 0  | 1  | 1  | 0  | 0 | 1 | 1 | 0 | 0 | 1 | 1 | 0 | 0 | 1 | 1 |  |  |  |  |
|      |      | 0  | 1  | 0  | 1  | 0  | 1 | 0 | 1 | 0 | 1 | 0 | 1 | 0 | 1 | 0 | 1 |  |  |  |  |
| 3210 | DDDD | 0  | 1  | 2  | 3  | 4  | 5 | 6 | 7 | 8 | 9 | A | B | C | D | E | F |  |  |  |  |
| 0000 | 0    |    |    | 0  | a  | P  | \ | P | Ä | E |   | - | ウ | 三 | α | P |   |  |  |  |  |
| 0001 | 1    |    | !  | 1  | A  | Q  | a | q | Ä | æ | ä | ア | チ | △ | ä | q |   |  |  |  |  |
| 0010 | 2    |    | "  | 2  | B  | R  | b | r | Ä | E | 「 | イ | ツ | × | β | θ |   |  |  |  |  |
| 0011 | 3    |    | #  | 3  | C  | S  | c | s | Ä | R | 」 | ウ | 〒 | E | ε | ∞ |   |  |  |  |  |
| 0100 | 4    |    | \$ | 4  | D  | T  | d | t | ä | ⊙ | \ | I | ト | ト | μ | Ω |   |  |  |  |  |
| 0101 | 5    |    | %  | 5  | E  | U  | e | u | E | o | ・ | オ | ナ | 1 | ε | Ü |   |  |  |  |  |
| 0110 | 6    |    | &  | 6  | F  | V  | f | v | Ü | ⊕ | ヲ | 力 | ニ | ヨ | ρ | Σ |   |  |  |  |  |
| 0111 | 7    |    | '  | 7  | G  | W  | g | w | ä | ◇ | フ | キ | フ | ラ | θ | π |   |  |  |  |  |
| 1000 | 8    |    | <  | 8  | H  | X  | h | x | ø | ! | イ | ウ | ホ | リ | フ | ア |   |  |  |  |  |
| 1001 | 9    | ♪  | )  | 9  | I  | Y  | i | y | ø | ¢ | ウ | ル | リ | ウ |   |   |   |  |  |  |  |
| 1010 | A    | ¢  | *  | :  | J  | Z  | j | z | Ü | Δ | エ | コ | ハ | レ | J | 〒 |   |  |  |  |  |
| 1011 | B    | £  | +  | ;  | K  | [  | k | ( | α | Δ | * | サ | ヒ | ロ | ° | 天 |   |  |  |  |  |
| 1100 | C    | ¥  | ;  | <  | L  | ¥  | l | l | \ | 2 | ト | ヨ | フ | ワ | ⊕ | 天 |   |  |  |  |  |
| 1101 | D    | ト  | -  | =  | M  | ]n | ) | 〒 | ¢ | ユ | ズ | ハ | ン | ト | ÷ |   |   |  |  |  |  |
| 1110 | E    | ¢  | .  | >  | N  | ^  | n | ÷ | ° | ↑ | ヨ | セ | ホ | ° | 天 |   |   |  |  |  |  |
| 1111 | F    | △  | /  | ?  | O  | _  | o | ÷ | Σ | ↓ | ウ | リ | マ | ° | ö |   |   |  |  |  |  |

Figure 2: Japanese Character Set

## Character RAM

CGRAM allows the creation of up to eight 5x7 character patterns. Seven bytes are assigned to each character address, the least significant five bits of which represent the five pixel columns. An eighth byte represents an underline spanning all five columns. Pixels are activated by setting the bit in their position in CGRAM to “1”.

Each character has eight addresses in CGRAM corresponding to each of its eight pixel rows. The highest three bits represent the character address in DDRAM. The lowest three bits of this address represent the row positions beginning with 0 at the top.

Finally, each character can be referenced in DDRAM and written to the screen using its eight bit character code. Note that each character is addressable by two codes.

Table 7: Relationship between CGRAM Addresses, Character Codes (DDRAM Data) and Character Patterns (CGRAM Data)

| Character code     | CG RAM address |     |     |     |     |     | CG RAM data (character pattern) |     |     |     |     |     |     |     |
|--------------------|----------------|-----|-----|-----|-----|-----|---------------------------------|-----|-----|-----|-----|-----|-----|-----|
|                    | DB5            | DB4 | DB3 | DB2 | DB1 | DB0 | DB7                             | DB6 | DB5 | DB4 | DB3 | DB2 | DB1 | DB0 |
| 00H<br>or<br>(0BH) | 0              | 0   | 0   | 0   | 0   | 0   | *                               | *   | *   | 1   | 2   | 3   | 4   | 5   |
|                    | 0              | 0   | 0   | 0   | 0   | 1   | *                               | *   | *   | 6   | 7   | 8   | 9   | 10  |
|                    | 0              | 0   | 0   | 0   | 1   | 0   | *                               | *   | *   | 11  | 12  | 13  | 14  | 15  |
|                    | 0              | 0   | 0   | 0   | 1   | 1   | *                               | *   | *   | 16  | 17  | 18  | 19  | 20  |
|                    | 0              | 0   | 0   | 1   | 0   | 0   | *                               | *   | *   | 21  | 22  | 23  | 24  | 25  |
|                    | 0              | 0   | 0   | 1   | 0   | 1   | *                               | *   | *   | 26  | 27  | 28  | 29  | 30  |
|                    | 0              | 0   | 0   | 1   | 1   | 0   | *                               | *   | *   | 31  | 32  | 33  | 34  | 35  |
|                    | 0              | 0   | 0   | 1   | 1   | 1   | *                               | *   | *   | 36  | 0   | 0   | 0   | 0   |
| 01H<br>or<br>(09H) | 0              | 0   | 1   | 0   | 0   | 0   | *                               | *   | *   | 1   | 2   | 3   | 4   | 5   |
|                    | 0              | 0   | 1   | 0   | 0   | 1   | *                               | *   | *   | 6   | 7   | 8   | 9   | 10  |
|                    | 0              | 0   | 1   | 0   | 1   | 0   | *                               | *   | *   | 11  | 12  | 13  | 14  | 15  |
|                    | 0              | 0   | 1   | 0   | 1   | 1   | *                               | *   | *   | 16  | 17  | 18  | 19  | 20  |
|                    | 0              | 0   | 1   | 1   | 0   | 0   | *                               | *   | *   | 21  | 22  | 23  | 24  | 25  |
|                    | 0              | 0   | 1   | 1   | 0   | 1   | *                               | *   | *   | 26  | 27  | 28  | 29  | 30  |
|                    | 0              | 0   | 1   | 1   | 1   | 0   | *                               | *   | *   | 31  | 32  | 33  | 34  | 35  |
|                    | 0              | 0   | 1   | 1   | 1   | 1   | *                               | *   | *   | 36  | 0   | 0   | 0   | 0   |

Note: \* Indicates no effect.

## Timing Characteristics

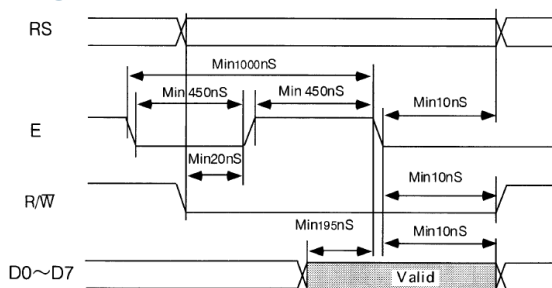

Figure 3: Write Timing Waveform

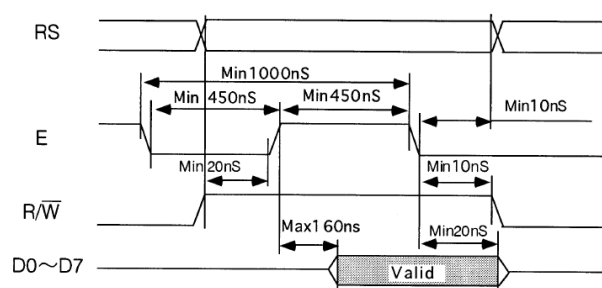

Figure 4: Read Timing Waveform



## Initialization

Before beginning any application, it is recommended that all display settings be initialized. Below are algorithms for initializing the display in both 8-bit and 4-bit communication modes.

Before the first wait condition, please allow  $V_{CC}$  to rise to 2.7V then wait 40ms. During the three function set commands that follow, note that the busy flag cannot be checked; it becomes available in the last block. The unit will always expect a total of 8 bits to be sent, so note the structure used in four bit mode. The last initialization block will set the number of lines and character font as specified, turn the display off, issue the display clear command, and finally set the entry mode as desired.

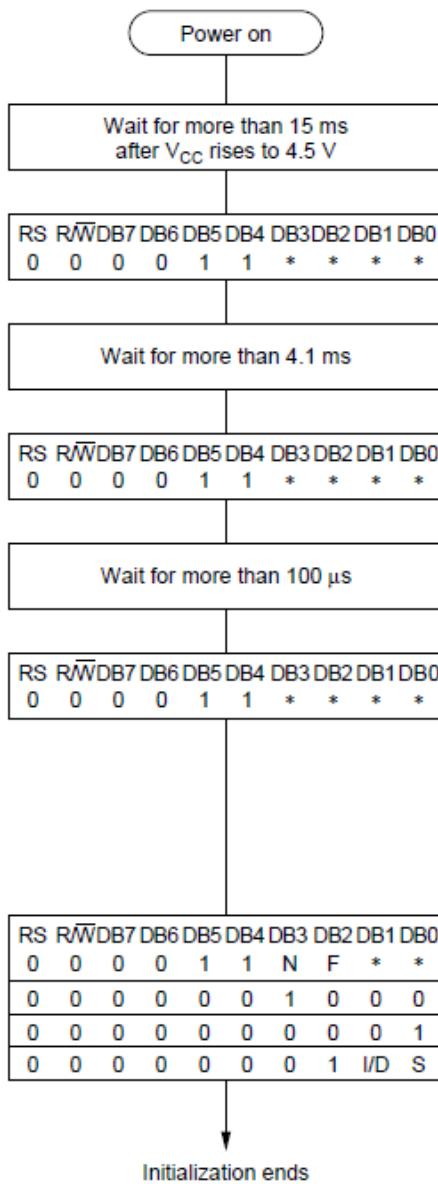

Figure 5: 8-bit Initialization

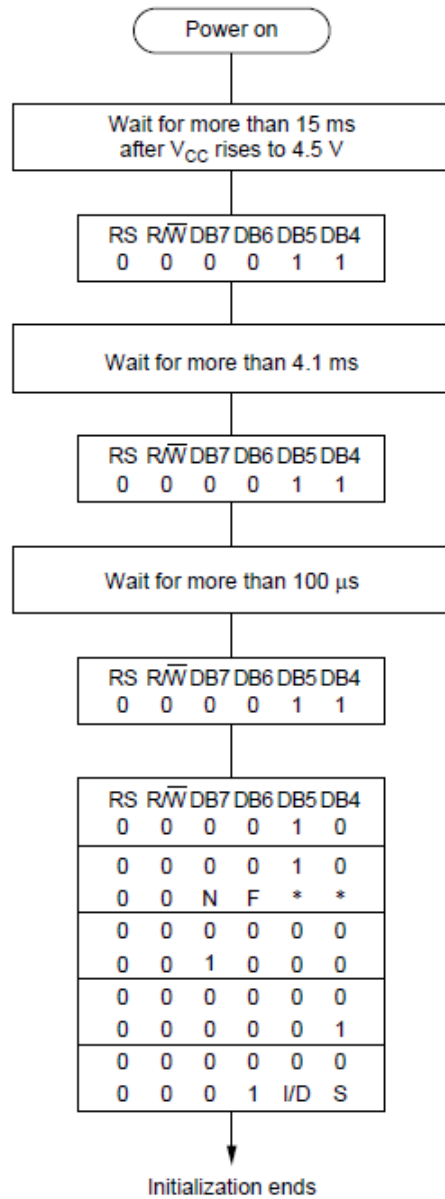

Figure 6: 4-bit Initialization

**Note:** \* Indicates do not care condition.

## Specifications

### Electrical

Table 8: Electrical Characteristics

| Item                            | Symbol          | Min  | Typ | Max             | Unit |
|---------------------------------|-----------------|------|-----|-----------------|------|
| Supply Voltage For Logic        | V <sub>CC</sub> | 4.75 | 5.0 | 5.25            | V    |
| Input Logic High Voltage        | V <sub>IH</sub> | 2.0  | —   | V <sub>CC</sub> | V    |
| Input Logic Low Voltage         | V <sub>IL</sub> | 0    | —   | 0.8             | V    |
| Supply Current (Display OFF)    | I <sub>CC</sub> | —    | 2   | 10              | mA   |
| Supply Current (Display ON)     | I <sub>CC</sub> | —    | 130 | 200             | mA   |
| Supply Current (Initial Inrush) | I <sub>CC</sub> | —    | 260 | 400             | mA   |

### Optical

Table 9: Display Characteristics

| Item                   | Dimension               | Unit              |
|------------------------|-------------------------|-------------------|
| Number of Characters   | 20 Characters x 2 Lines | —                 |
| Module dimension       | 116.0 x 37.0 x 16.0     | mm                |
| Active area            | 70.8 x 11.5             | mm                |
| Character size         | 2.40 x 4.70             | mm                |
| Character pitch        | 3.60 x 6.10             | mm                |
| Dot size               | 0.40 x 0.50             | mm                |
| Dot pitch              | 0.50 x 0.70             | mm                |
| Luminance              | 350                     | cd/m <sup>2</sup> |
| Colour of Illumination | Green (Blue-Green)      |                   |

### Environmental

Table 10: Environmental Specifications

| Item            | Symbol | Min | Max | Unit |
|-----------------|--------|-----|-----|------|
| Operating Temp. | Top    | -40 | 85  | °C   |
| Storage Temp.   | Tstr   | -50 | 85  | °C   |

**Note:** Maximum 80% non-condensing humidity.

## Troubleshooting

### Power

For your MOP Display to function correctly, appropriate power must be applied, often as indicated by the cursor or text illuminating. Please reference all voltages to the Initialization

Before beginning any application, it is recommended that all display settings be initialized. Below are algorithms for initializing the display in both 8-bit and 4-bit communication modes.

Before the first wait condition, please allow V<sub>CC</sub> to rise to 2.7V then wait 40ms. During the three function set commands that follow, note that the busy flag cannot be checked; it becomes available in the last block. The unit will always expect a total of 8 bits to be sent, so note the structure used in four bit mode. The last initialization block will set the number of lines and character font as specified, turn the display off, issue the display clear command, and finally set the entry mode as desired.

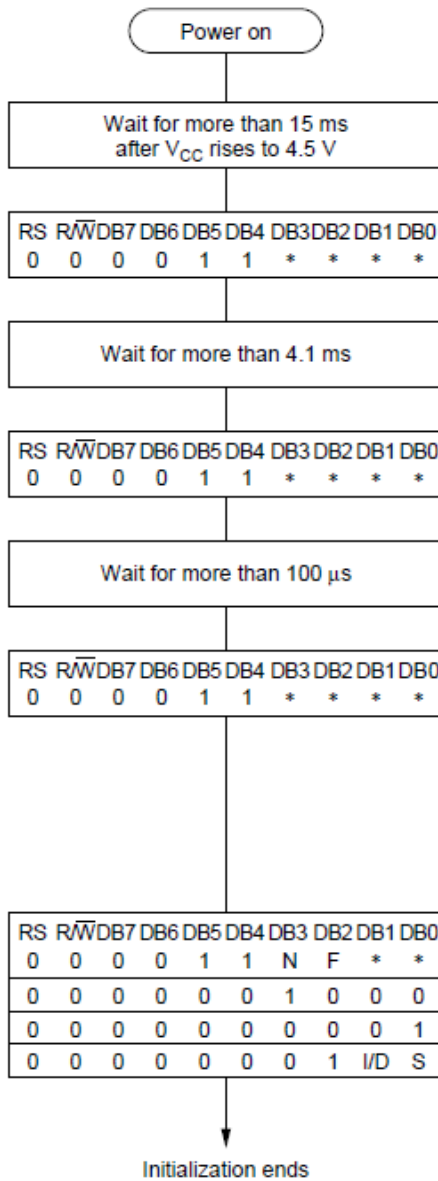

Figure 5: 8-bit Initialization

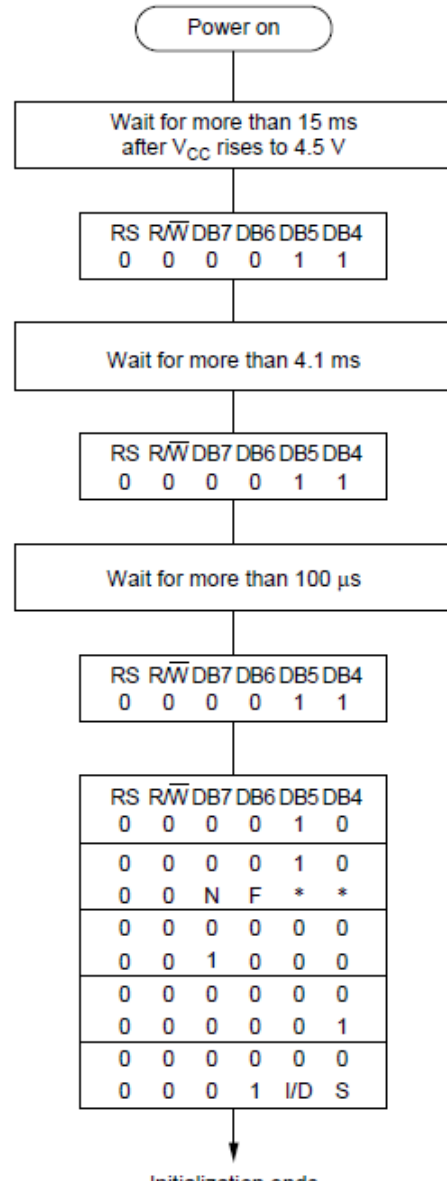

Figure 6: 4-bit Initialization

**Note:** \* Indicates do not care condition.

Specifications provided.

## Display

If your display is powered successfully, the text or cursor may be evident. Ensure the correct power is applied and the expected DDRAM addresses are shown by moving the display to the home position.

## Communication

When communication of either text or commands is interrupted, check all data and control pins for continuity. Ensure the display has been initialized correctly before sending information using the

appropriate initialization algorithm. For 4-bit mode ensure D4-D7 are used. Finally, slow down communication and refer to Timing Characteristics for proper control flow.

## Test Mode

Test mode is initiated by connecting 2 and 3 pin of the 3pin connector CN2 before applying power. In the test mode, a checker pattern is displayed across all characters of the screen. Please note that CN2 may be removed in the future.

## Precautions

- Operation outside absolute maximum ratings may cause permanent damage.
- Ensure Anti-Static handling procedures are followed. Store in an anti-static container within a clean environment.
- Do not make extra holes on the display, modify its shape, or change the components. Do not drop, bend, twist, or disassemble the display.
- Physical shock greater than 100G, thermal shock in excess of 10°C/minute, or a direct hit to the glass display surface may crack the glass.
- Do not PUSH the display strongly. At mounting to the system frame, slight gap between display glass face and front panel is necessary to avoid a contact failure of lead pins of display. Twist or warp mounting will make a glass CRACK around the lead pin of display.
- Neither data nor power connectors should be connected or disconnected while power is applied. Removal of primary power with logic signals applied may damage input circuitry.
- Power must be regulated completely since all control logic depends on this line. Do not apply slow-start power. Provide sufficient power to supply inrush current at startup.
- Data cable length between module and host system is recommended within 300 mm to be free from a miss-operation caused by noise.
- Running in test mode for 2 hours may help the stability of the brightness of them VFD when power has not applied more than 2 months.
- Displaying a fixed (static) message longer than 5 hours in a day may cause the phosphor to burn-out. An automatic shut down in programming, scrolling message, or test mode operation during idling of the host is recommended.

## Ordering

### Part Numbering Scheme

Table 11: Parallel Part Numbering Scheme

|            |   |          |          |           |          |          |   |          |          |          |          |   |          |          |          |   |          |          |          |
|------------|---|----------|----------|-----------|----------|----------|---|----------|----------|----------|----------|---|----------|----------|----------|---|----------|----------|----------|
| <b>MOP</b> | - | <b>A</b> | <b>V</b> | <b>20</b> | <b>2</b> | <b>C</b> | - | <b>B</b> | <b>N</b> | <b>N</b> | <b>N</b> | - | <b>0</b> | <b>1</b> | <b>J</b> | - | <b>3</b> | <b>I</b> | <b>N</b> |
| 1          |   | 2        | 3        | 4         | 5        | 6        |   | 7        | 8        | 9        | 10       |   | 11       | 12       | 13       |   | 14       | 15       | 16       |

### Options

Table 12: Parallel Part Options

| #  | Designator                  | Options   |
|----|-----------------------------|---|
| 1  | Product Line                | MOP: Matrix Orbital Parallel Display                          |
| 2  | Display Type                | A: Alphanumeric   |
| 3  | Screen Type                 | V: Vacuum Florescent Display                                  |
| 4  | Display Columns             | 16: Sixteen Character Columns<br>20: Twenty Character Columns |
| 5  | Display Rows                | 2: Two Character Rows<br>4: Four Character Rows               |
| 6  | Display Form Factor         | A: A Form Factor<br>C: C Form Factor                          |
| 7  | IC Package                  | B: Chip on Board  |
| 8  | LCD Glass Type              | N: Not Applicable   |
| 9  | Polarizer Style             | N: Not Applicable   |
| 10 | Backlight Colour            | N: Not Applicable   |
| 11 | Viewing Angle               | 0: Not Applicable   |
| 12 | Controller                  | 1: HD44870 Compatible   |
| 13 | Character Set               | J: Japanese   |
| 14 | Input Voltage               | 3: 5.0V   |
| 15 | Temperature Range           | I: Industrial   |
| 16 | Negative Voltage Generation | N: None Provided  |

## Contact

### Sales

Phone: 403.229.2737

Email: [sales@matrixorbital.ca](mailto:sales@matrixorbital.ca)

### Support

Phone: 403.204.3750

Email: [support@matrixorbital.ca](mailto:support@matrixorbital.ca)

### Online

Purchasing: [www.matrixorbital.com](http://www.matrixorbital.com)

Support: [www.matrixorbital.ca](http://www.matrixorbital.ca)