

THIS DOCUMENT IS THE PROPERTY OF KEYSTONE ELECTRONICS CORP. AND SHALL NOT BE REPRODUCED, DISTRIBUTED OR USED AS A BASIS FOR MANUFACTURE WITHOUT PRIOR WRITTEN PERMISSION FROM KEYSTONE ELECTRONICS CORP.

MTG DETAILS

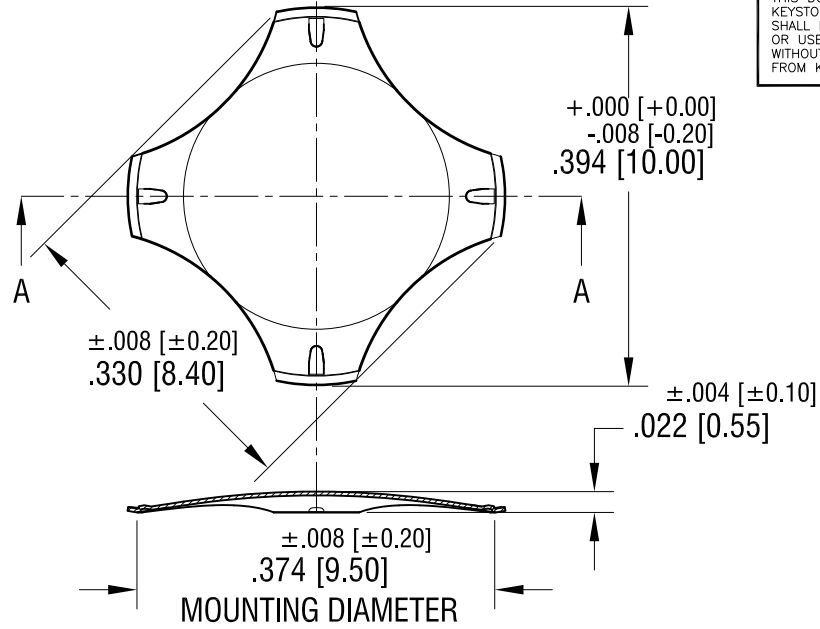

ACTUAL SIZE

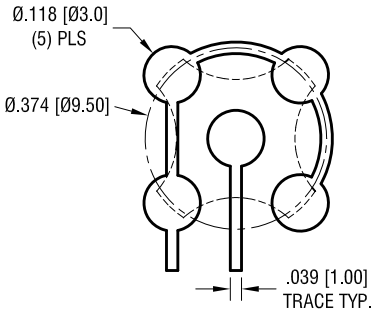

SECTION A-A

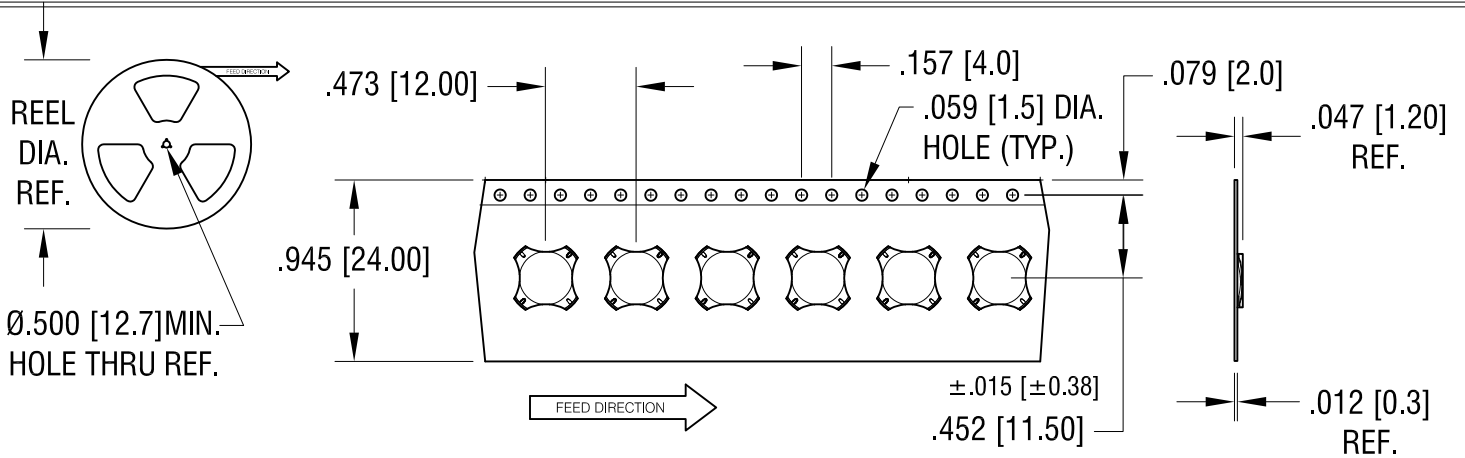

DOME SPECIFICATIONS:

1. VOLTAGE/CURRENT MAXIMUM: 12mA@ 24 Volts DC
2. OPERATING TEMPERATURE: -40°C TO 105°C
3. STORAGE TEMPERATURE: -55°C TO 125°C
4. MAT'L: .004 [0.10] STAINLESS STEEL
5. FINISH: NICKEL PLATE
6. TRIP FORCE: 280g

NOTES: SUPPLIED ON TAPE AND REEL ONLY

TAPE AND REEL SPECIFICATIONS:

1. TAPE:
MAT'L - ALL CONDUCTIVE POLYSTYRENE CARRIER
ANSI/EIA-481 STANDARD
2. REEL:
13.0 [330.2] DIA. 4000 PIECES PER REEL

KEYSTONE ELECTRONICS CORP.

www.keyelco.com • ASTORIA, N.Y. 11105-2017 • Tel (718) 956-8900

PART NAME		COMPACT 4 LEG DOME	
MATERIAL		AS NOTED	
FINISH	AS NOTED	DRN BY	NT
		DATE	2.15.17
		APP'D	LN
		SCALE	5X; 1X
TOLERANCES	INCH [MM]	CODE	DWG NO.
DECIMAL	± .005 [± 0.13]	C	
ANGULAR	± 1°		
UNLESS OTHERWISE SPECIFIED			

5154TR

DATE	DESCRIPTION	REV.